

## Scanning the Issue

**Adjustable Speed AC Drives—A Technology Status Review** (*Invited Paper*), Bose, page 116—After nearly a decade and a half of intensive development, adjustable speed ac drives have assumed a position of great importance in a large variety of industrial applications. This has led to a pressing need in the industrial and academic communities for an understanding of the basics and state of the art of this growing technology. This invited paper, believed to be the first of its kind on this subject, is a tutorial-review of ac drives intended to be useful both to the reader who has a general interest in industrial control using ac drives and to the specialist who wishes to extend and expand his or her knowledge.

The ac machines which constitute the principal subsystem of these drives are first concisely but thoroughly reviewed in the paper. Following this, the technical features of different classes of drives with converters, such as voltage-fed converters, current-fed converters, cycloconverters, static Kramer, and static Scherbius drives, are discussed. The paper then describes modeling and simulation of ac drives, and finally the subject of microcomputer control is reviewed in some detail. Throughout the paper, the current trends of development of power semiconductor devices, machines, converters, and controls are indicated wherever possible.

**The Persistent Paradox of Psychic Phenomena: An Engineering Perspective** (*Invited Paper*), Jahn, page 136—The persistent, fragmentary indication of the possible existence of psychic phenomena requires us, in the interests of scientific integrity and intellectual honesty, to apply the same spirit of objective inquiry that we have focused on the more traditional and accepted branches of science and technology.

It was nearly six years ago—in March 1976, to be exact—that the PROCEEDINGS took the unusual step of publishing a paper on the psychic phenomenon called remote viewing. That paper was received with great interest, considerable skepticism, some hostility, and even a bit of shock. In the intervening years, no breakthroughs have occurred to prove or disprove the existence of this and other psychic phenomena, but interest and research have continued unabated. Where does research on these topics

stand now? It was with this question in mind that the paper in this issue was invited.

This paper reviews the history, nomenclature, conceptual organization, and status of the generic field of psychic phenomena; presents a few detailed examples of contemporary research that could have ultimate technological implications; and attempts to offer a balanced view of the viability and value of continued study of this fascinating and controversial field.

The paper is believed to represent the first attempt at a comprehensive engineering survey of the field. Most readers will likely approach it with a healthy blend of curiosity and skepticism. It is hoped all will find it informative and thought provoking.

**Performance Evaluation of Data Communication Systems** (*Invited Paper*), Reiser, page 171—Great strides have been taken in recent years in developing the architecture of message or packet-based communication networks. Much has been learned about organizing, controlling, and operating such networks, but performance and design principles were developed in parallel, and networks were built before a complete understanding of their performance was achieved. Major progress has been made in evaluating the performance of such communication systems, and this invited paper presents a tutorial survey of the state of the art of this field. The majority of the literature on performance evaluation emphasizes protocol evaluation, and the author systematically develops this approach.

Following a general introduction to performance evaluation, the paper gives considerable attention to the mathematical tools involved, using the language of the communication engineer. The major mathematical techniques are Markov chains applied to discrete time systems and queueing theory. Throughout emphasis is given to how these tools are applied in practice. The mathematical methods do not map on a one-to-one basis to the system, and the leading modeling ideas are highlighted. The embedding environments in which protocols are analyzed are discussed in some detail, and the paper follows the framework of layered architecture. Separate sections are devoted to the performance analysis of data-link protocols, path-control protocols, and end-to-end protocols.

This document is made available through the declassification efforts  
and research of John Greenewald, Jr., creator of:

# The Black Vault



The Black Vault is the largest online Freedom of Information Act (FOIA) document clearinghouse in the world. The research efforts here are responsible for the declassification of hundreds of thousands of pages released by the U.S. Government & Military.

**Discover the Truth** at: <http://www.theblackvault.com>

- [132] M. Schwartz, "Performance analysis of the SNA virtual route pacing control," IBM Res. Rep. RC 8490, Thomas J. Watson Research Center, Yorktown Heights, NY, Sept. 1980.
- [133] F. Tobagi and L. Kleinrock, "Packet switching in radio channels: Part IV—Stability considerations and dynamic control in carrier sense multiple access," *IEEE Trans. Commun.*, vol. COM-25, pp. 1103-1120, Oct. 1977.
- [134] F. A. Tobagi, M. Gerla, R. W. Peebles, and E. G. Manning, "Modeling and measurement techniques in packet communication networks," *Proc. IEEE*, vol. 66, no. 11, pp. 1423-1447, Nov. 1978.
- [135] F. A. Tobagi and V. B. Hunt, "Performance analysis of carrier sense multiple access with collision detection," *Comput. Net.*, vol. 4, pp. 245-259, 1980.
- [136] V. L. Wallace, "Algebraic techniques for the numerical solution of queueing networks," in *Mathematical Methods in Queueing Theory*, A. B. Clarke, Ed. Berlin, Germany: Springer, 1974, pp. 295-305.
- [137] C. H. West, "General technique for communications protocol validation," *IBM J. Res. Devel.*, vol. 22, no. 4, pp. 393-404, July 1978.
- [138] J. W. Wong and M. S. Unsoy, "Analysis of flow control in switched data networks," in *Proc. IFIP Conf. on Information Processing*. Amsterdam, The Netherlands: North-Holland, 1977, pp. 315-320.
- [139] J. W. Wong, "Distribution of end-to-end delay in message switched networks," *Comput. Net.*, vol. 2, pp. 4-49, 1978.
- [140] J. W. Wong, J. A. B. Moura, and J. A. Field, "Hierarchical modeling of local area computer networks," in *Proc. Nat. Telecommun. Conf. '80* (Houston, TX, 1980).
- [141] J. W. Wong and S. S. Lam, "Queueing network models of packet-switching networks, Part 1: Open networks," *Performance Evaluation*, to be published.
- [142] P. Zafropulo, C. H. West, H. Rudin, D. D. Cowan, and D. Brand, "Towards analyzing and synthesizing protocols," *IEEE Trans. Commun.*, vol. COM-28, pp. 651-661, Apr. 1980.

## Contributors



**Bimal K. Bose (S'59-M'60-SM'78)** received the B.E. degree from Calcutta University, Calcutta, India, in 1956, the M.S. degree from the University of Wisconsin, Madison, in 1960, and the Ph.D. degree from Calcutta University, in 1966.

He was a Member of Faculty at Calcutta University where he was awarded the Premchand Roychand scholarship and the Mouat gold medal for research contributions. In 1971, he joined Rensselaer Polytechnic Institute, Troy, NY, as an Associate Professor of Electrical

Engineering. He was responsible for organizing undergraduate and graduate power electronics programs, including an advanced course on adjustable speed ac drives. He was a consultant for several industries including General Electric R&D Center, Bendix Corporation, Lutron Electronics, and PCI Ozone Corporation. Since 1976 he has been with General Electric, Corporate Research and Development, Schenectady, NY. His research interests are power conversion systems and micro-computer-based performance optimization of ac drives.

Dr. Bose has published 42 research papers and holds a number of U.S. patents. Recently, he edited the IEEE press book *Adjustable Speed AC Drives*. He is Chairman of IEEE Transactions Review of Static Power Converter Committee, a member of the Power Electronics and Micro-computer Control Committee, the IEEE Industrial Electronics and Control Instrumentation Group, the Scientific Committee of the International Conference on Digital Control of Electrical Machine, and of the Program Committee of the International Static Power Converter Conference, a member of the Steering Committee for the Workshop on Automotive Applications of Microprocessors, a member of the Fellow Nominating Committee for the IEEE Static Power Converter Committee, and a member of the Program Committee of the Tokyo International Power Electronics Conference.



**Robert G. Jahn** received the B.S. degree in mechanical engineering in 1951, the M.A. degree in physics in 1953, and the Ph.D. degree in physics in 1955, all from Princeton University, Princeton, NJ.

He has taught at Lehigh University, Bethlehem, PA, at the California Institute of Technology, Pasadena, and, since 1962, at Princeton University, where he is Dean of the School of Engineering and Applied Science and also serves as Professor of Aerospace Sciences. His principal

areas of scholarship include high temperature gasdynamics, ionized gas kinetics, plasmadynamics and plasma propulsion, and his book, *The Physics of Electric Propulsion* remains the standard text in its field. His interest in psychic phenomena traces to his supervision of a student project begun in 1977, and although his present program in this area remains a very minor part of his professional activity, it has achieved international prominence in the field.

Dr. Jahn received the Curtis W. McGraw Research Award of the ASEE, and he is a Fellow of both the American Physical Society and the American Institute of Aeronautics and Astronautics. He has served on several NASA Advisory Committees, and is a member and past-chairman of the Board of Trustees of Associated Universities, Inc.

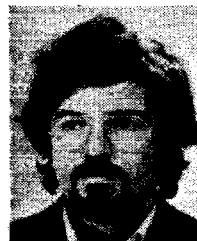

**Martin Reiser** was born in Switzerland in 1943. He received his education from the Swiss Federal Institute of Technology (ETH) where he obtained the Ph.D. degree in 1971.

One year later, he switched from the IBM Zurich Research Laboratory, Rüschlikon, Switzerland, to the IBM Thomas J. Watson Research Center, Yorktown Heights, NY, where he joined the Performance Evaluation group. He specialized in the numerical solution of queueing networks, and made contributions to the theory

of multichain networks and their numerical solution. Together with J. Buzen and H. Kobayashi, he laid the foundation for today's fast algorithms in queueing networks and created one of the first modeling software packages, known as QNET 4. He is author or co-author of numerous publications in the field. After spending about 1 year at the IBM Research Laboratory in San José, CA, he returned to Yorktown Heights where he was soon appointed Manager of Performance Evaluation. He led efforts in analysis, hierarchical modeling, and system measurement. In late 1977, he started a new group in the area of Computer Communication Network Modeling and Architecture. This activity led to a new assignment in 1978 as Senior Manager of Communications and Computer Science back at the IBM Zurich Research Laboratory, a position he still holds. His latest technical interests are in mean-value analysis, a theory he co-founded with S. S. Lavenberg and which he applied to computer networks.

Dr. Reiser is a member of ACM, IFIP WG.7.3, and IFIP WG 6.4.

# The Persistent Paradox of Psychic Phenomena: An Engineering Perspective

ROBERT G. JAHN

*Invited Paper*

*Abstract*—Although a variety of so-called psychic phenomena have attracted man's attention throughout recorded history, organized scholarly effort to comprehend such effects is just one century old, and systematic academic research roughly half that age. Over recent years, a sizeable spectrum of evidence has been brought forth from reputable laboratories in several disciplines to suggest that at times human consciousness can acquire information inaccessible by any known physical mechanism (ESP), and can influence the behavior of physical systems or processes (PK), but even the most rigorous and sophisticated of these studies display a characteristic dilemma: The experimental results are rarely replicable in the strict scientific sense, but the anomalous yields are well beyond chance expectations and a number of common features thread through the broad range of reported effects. Various attempts at theoretical modeling have so far shown little functional value in explicating experimental results, but have served to stimulate fundamental re-examination of the role of consciousness in the determination of physical reality. Further careful study of this formidable field seems justified, but only within the context of very well conceived and technically impeccable experiments of large data-base capability, with disciplined attention to the pertinent aesthetic factors, and with more constructive involvement of the critical community.

## *Prologue*

*The world of psychic phenomena might be likened to a vast, fog-shrouded swamp, wherein are reported to dwell a bewildering array of bizarre phenomenological creatures, all foreign to our normal perceptual and analytical catalogs. Some scholars who have explored this clouded domain have returned to announce categorically that all such life is illusory—mere sunken stumps and swirling subsurface shadows, inviting misperception by the gullible and misrepresentation by the purveyors. But others of comparable conviction have described in minute detail their observations of a variety of extraordinary beings of awesome dimensions and capability. Some of these are claimed to appear unexpectedly, erupting from the roily depths to flash momentarily in the sunlight of human experience, only to disappear again before any systematic calibration of their characteristics can be taken. Others are reportedly enticed to more replicable and controlled behavior, but only by persons of special talent or extensive training. Much invalid, even fraudulent evidence of such activity has been touted by exploiters of these mysteries, thereby casting deep suspicion on all other testimony. When fully sifted, only a very few legiti-*

Manuscript received July 15, 1981; revised October 26, 1981. This work was supported in part by the McDonnell Foundation, Inc., and by the John E. Fetzer Foundation, Inc., The Explorers Club, the Institute of Noetic Sciences, and the Little River Foundation.

The author is Dean of the School of Engineering/Applied Science, Princeton University, Princeton, NJ 08544.

*mate specimens seem to have been captured, by tediously deliberate trolling of the brackish domain, or by more incisive invasion of its turbid interior, and even these have proven so incomprehensible and so delicate to exposure, and the imposed criteria for their credibility have been so severe, that they have not been fully persuasive. Yet the goal remains alluring, and the search continues.*

## INTRODUCTION

WITH THIS unlikely bit of allegorical musing, I venture to begin the most extraordinary writing task I have yet attempted: to respond to the request of the Editors of this journal for a critical review of the status and prognosis of scientific research into so-called psychic phenomena. I do so with some trepidation, first because the topic is far from my principal line of scholarship and my involvement with it has been brief and tightly circumscribed, and second, because of the intensity of reactions any commentary on this subject tends to call forth from many quarters.

For these reasons, it may be well at the outset to specify my perspective on the field and the purpose that I hope this article will serve. My formal training is that of an engineer and applied physicist, and the bulk of my research has concerned a sequence of topics in the broad domain of the aerospace sciences: fluid mechanics, ionized gases, plasmadynamics, and electric propulsion. In my present position as Dean of the School of Engineering and Applied Science of Princeton University, I have occasion to be involved with an even broader selection of topics selected for undergraduate independent projects, and it was in that context some four years ago that I was requested by one of our very best students to supervise a study of psychic phenomena. More specifically, this young lady proposed to bring her talents and background in electrical engineering and computer science to bear on some experiments in controlled, low-level psychokinesis. Although I had no previous experience, professional or personal, with this subject, for a variety of pedagogical reasons I agreed, and together we mapped a tentative scholarly path, involving a literature search, visits to appropriate laboratories and professional meetings, and the design, construction, and operation of simple experiments. My initial oversight role in this project led to a degree of personal involvement with it, and that to a growing intellectual bemusement, to the extent that by the time this student graduated, I was persuaded that this was a legitimate field for a high technologist to study and that I would enjoy continuing to do so.

I have since assembled a small professional staff, secured the requisite funding from a few private sources, and undertaken a modest experimental program in selected aspects of the field that could ultimately have some engineering implications. I should emphasize that my fractional involvement with this program remains quite minor in comparison to my other responsibilities, and that the work is still very preliminary and tentative, but it provides the base of cognizance for my broader observations on the field as a whole.

The intention of this article is to provide some balanced perspective on the modern status of this conceptually and logistically difficult subject. Certainly no field of scholarly endeavor has proven more frustrating, nor has been more abused and misunderstood, than the study of psychic phenomena. Dealing as it does as much with impressionistic and aesthetic evidence as with analytical substance, and carrying by its nature strongly subjective and numenistic overtones, it has been incessantly prostituted by charlatans, lunatics, and sensationalists, categorically rejected by most of the scientific establishment, and widely misunderstood by the public at large. Interspersed with this, and greatly encumbered by it, a pattern of legitimate effort to comprehend and utilize the purported phenomena has evolved to a point where some dispassionate assessment of its accomplishments can be attempted. The questions addressed by this review are whether, once the overburdens of illegitimate activity and irresponsible criticism are removed, there remains sufficient residue of valid evidence to justify continued research and, if so, how this research might most effectively be styled, facilitated, and evaluated.

Before addressing these issues directly, it may be helpful to review briefly the historical evolution of the field, its contemporary nomenclature and conceptual organization, and the dimensions of current activity. This can then be followed by a general overview and critique of the modern research, and that in turn by more detailed description of a few specific efforts, drawn primarily from our own work. Toward the close, we shall attempt to survey several theoretical approaches to modeling of psychic processes and comment briefly on potential implications and applications of the phenomena. In all of this, no tone of advocacy is intended, other than for objective assessment of the evidence in hand.

### HISTORY

In a sense, the study of psychic phenomena is one of the oldest of human endeavors [1]-[7]. As far back as can be traced, mortal man has pondered the supernatural in one form or another. Cave drawings at Lascaux and Altamira, circa 20 000 B.C., reflect this preoccupation, and the religious rites of early societies of both the eastern and western worlds were heavily loaded with psychic formalisms. The classic civilizations of Egypt, Greece, and Rome dealt extensively in psychic process. The Delphic Oracle was politically important from the earliest Hellenic times to the age of Alexander the Great, and was consulted on problems as diverse as the proper measures to stop a plague, the constitutions of Greek city-states, and the best locations for new colonies. Even Aristotle, one of the most empirical of the classical philosophers, examined the causal links in prophetic dreams.

Virtually every form of organized religion practiced by man has been thoroughly laced with various forms of psychic mechanism. The Bible, like most other basic theological texts, treats psychic process as a central ingredient, in a tone so matter-of-fact that one is inclined to believe that people of those times

accepted such events rather routinely. Indeed, the Bible is an excellent catalog of psychic phenomena; virtually every category of effect identified today is illustrated there in one form or another.

Christian writers and philosophers, from Augustine to the Reformation, recount many purported instances of psychic phenomena, usually attributed to visitations of divine grace or demonic possession. Secular medieval writing also abounds with supernatural and mystical reference, and even in the Renaissance period it is still difficult to separate psychic allusion from religious dogma, although both were then translated into more organized forms in art and literature. Early in the 16th century the celebrated Swiss physician and philosopher Paracelsus wrote extensively on psychic capabilities and potentialities. In his words:

The mind of man is the microcosmic counterpart of the universal mind . . . . . One man may communicate his thoughts to another with whom he is in sympathy, at any distance however great it may be, or he may act upon the spirit of another person in such a manner as to influence his actions . . . [8].

Perhaps the first major scientific commentaries on the topic were offered near the turn of the 17th century by Sir Francis Bacon, widely regarded as the originator of the scientific method. In *The Advancement of Learning* he suggested that "superstitions and the like" should not be excluded from scientific study, and in his posthumous book, *Sylva Sylvarum*, he proposed deliberate investigation of telepathic dreams, psychic healing, and the influence of "imagination" on the casting of dice [9]. Some years later, a group of British intellectuals including Henry More and Joseph Glanvill met regularly to discuss paranormal topics, and in 1681 Glanvill published the substance of these studies in a book entitled *Saducismus Triumphatus* [10].

Meanwhile, some four centuries of public and church hysteria over sorcery and witchcraft, as manifested in a sequence of trials, tortures, and executions, had begun to subside, and by the mid-18th century, the Roman Church authorized Prospero Lambertini, who later became Pope Benedict XIV, to carry out a scholarly investigation of reports of psychic events. His conclusions, recorded in *De Canonizatione* [11], were surprisingly unecclesiastical: namely, that 1) psychic experiences were not necessarily divine miracles, but could occur to "fools, idiots, melancholy persons, and brute beasts"; 2) apparitions had little to do with sanctity or demonic entities; 3) prophecy occurs more often in sleep than in waking; 4) it is difficult for a prophet to distinguish his own thoughts from extrasensory messages; and 5) predictions frequently take symbolic forms. In all of these, he presaged to some degree modern thoughts on these topics.

At roughly the same time, Anton Mesmer's discovery of hypnosis opened an alternative route to demonstration and study of unconscious psychic process that has continued to this day. Early reports of hypnotized subjects performing telepathic or clairvoyant tasks were common [12], [13], and although much of this evidence might now be discounted on the basis of inadequate experimental control, interest in hypnosis specifically, and in various altered states of consciousness generally, as facilitators of psychic experience persists into some of the modern experimentation.

Also in this mid-18th century period, a spiritualist movement focused on extrasensory contact with the dead, possibly influenced by the work of Emanuel Swedenborg [14], [15], germinated in this country as well as in England, and by the

19th century had reached the dimensions of an organized religion. Symbolic of the popular preoccupation with the topic, Mary Todd Lincoln was reported to have held séances in the White House in the early 1860's [16]. A classic two-volume work by F.W.H. Myers, entitled *Human Personality and the Survival of Bodily Death* [17], brought the topic to its acme of sophistication, but eventually the fanaticism the movement attracted and its fraudulent exploitation created a negative attitude in the scholarly community which prevails yet today.

Despite these millennia of human concern with the paranormal, orderly and organized scholarly search for verification and understanding of psychic phenomena began only a century ago, with the establishment in London in 1882 of the Society for Psychical Research, in whose Proceedings appeared the first formal publication of controlled experiments in telepathy and clairvoyance [13], [18], [19]. Three years later the counterpart organization in this country, the American Society for Psychical Research, was founded in Boston by several distinguished scientists and philosophers. Because of financial difficulty, this shortly merged with the British group, but re-emerged in 1905 as a separate entity with its own professional journal, and has continued as such to the present [20].

Although the SPR attracted a barrage of criticism from the scientific and intellectual communities, it also attracted significant participation of eminent scholars from established fields. Numbered among its presidents are three Nobel Laureates, ten Fellows of the Royal Society, one Prime Minister, and a substantial list of physicists and philosophers, including Henry Sidgwick, Frederic W. H. Myers, Lord Rayleigh, Sir J. J. Thomson, William McDougall, Edmund Gurney, Sir William Crookes, Sir William Barrett, Henri Bergson, Arthur, Earl of Balfour, Gardner Murphy, G.N.M. Tyrell, Charles Richet, Gilbert Murray, and one of the most articulate contributors to the evolution of critical thought on this topic in this period, the Harvard psychologist and philosopher, William James. One of the founders of the ASPR, James wrote extensively and eloquently on behalf of objective and disciplined study of psychic phenomena [21]-[25]:

Any one with a healthy sense for evidence, a sense not methodically blunted by the sectarianism of 'science,' ought now, it seems to me, to feel that exalted sensibilities and memories, veridical phantasms, haunted houses, trances with supernormal faculty, and even experimental thought-transference, are natural kinds of (phenomena) which ought, just like other natural events, to be followed up with scientific curiosity [25].

Entering the 20th century, a new perspective on psychic phenomena was provided by the emergence of psychology as a scholarly discipline, and especially by the early efforts in clinical psychology and psychoanalytic therapy. The patriarch of this evolution, Sigmund Freud, was a member of the SPR and contributed, albeit somewhat reluctantly, to its publications [26], [27]. His recognition and exploration of the unconscious mind and of the function of dreams prompted Myers to suggest a possible explication of various psychic effects which is still of theoretical value [17]. Freud's interest in parapsychology increased toward the end of his life, and he is reported to have conceded informally that were he to begin his career anew, he would focus on this topic.

Freud's former protégé, Carl Jung, who had written his Ph.D. thesis on the psychology of occult phenomena, pursued exploration of the unconscious to deeper dimensions of paranormal experience, publishing widely on such subjects as telepathy, mediumship, synchronicity, the collective unconscious, and theoretical models of psychic process [28]-[30]. In

*Memories, Dreams, Reflections*, he stated:

... the relationship between doctor and patient, especially when a transference on the part of the patient occurs, or a more or less unconscious identification of doctor and patient, can lead to parapsychological phenomena. I have frequently run into this [30].

Jung's collaboration with the eminent physicist Wolfgang Pauli on the topic of synchronicity clearly influenced the subsequent evolution of both careers and of fundamental concepts in both disciplines [31]. Although much of the established psychological community has since rejected parapsychology as a valid discipline, some interest has been retained by a few clinical practitioners, presumably because of the demonstrated concomitance and similarities of apparent psychic experiences with certain psychological processes [32], [33].

It was also early in this century that the first organized academic studies of psychic phenomena were mounted. One of the more visible of these devolved from gifts and a bequest from Thomas W. Stanford, brother of the founder of Stanford University, to endow psychic research at that institution, and to this day the university provides support of a "psychic research fellow" and retains a collection of so-called "apports" indicative of the donor's long personal involvement with the field. Modest research programs were also undertaken at Harvard and a few European universities in the first decades of this century, as evidenced by occasional publications in various established journals.

The benchmark academic effort, however, germinated at Duke University in the late 1920's, when William McDougall, who had been James' successor at Harvard, arrived to chair the department of psychology and appointed J. B. Rhine and Louisa Rhine, "to study the claims to scientific value of the field known as psychical research." Their early tentative efforts in the study of postmortem survival gradually evolved into a laboratory for controlled research in "extrasensory perception," as they first termed the process. In this laboratory were established many of the basic concepts and protocols of modern psychic research, as well as the first extensive and systematic data bases of several types of psychic experimentation. The professional and personal history of the Rhines and their laboratory is a fascinating saga in its own right, but would take us too far afield here [34]-[37]. A few excerpts from a 1967 address of J. B. Rhine to the American Psychological Association, in which he attempted to summarize his first two decades of intensive study, give hint of the inherent attractions and frustrations of this field, and of the man's optimistic vision:

The phenomena that were being studied began to show lawful interrelations and even a degree of unity. One by one the major claims, based originally only upon spontaneous human experiences, were subjected to laboratory test and experimentally verified... Certain general characteristics of the psi process became clear during this period. The most revealing of these is the subject's lack of conscious control over any type of psi ability, a characteristic which accounts for its elusive nature. It was new methodological ground, even for psychology... Also, we were surprised to find that psi ability is widespread, probably even a specific human capacity rather than a capability possessed by a few rare individuals as had been the popular belief. Evidence that psi is not linked with illness or abnormality was another welcome advance... By 1951... a healthy young science was emerging [38].

In 1937, the Rhines began publication of the *Journal of Parapsychology*, which remains a leading journal in the field today. A professional organization calling itself the Parapsychological Association was formed in 1957, and in 1969 was

accepted as an affiliate by the American Association for the Advancement of Science.

At the present time, there are eight English language publications covering this field [39], supplemented by numerous less formal magazines and countless books of widely varying quality and relevance. Research activity is reported from some twenty U.S. universities and colleges and at least as many institutions in Western Europe [40], but in most cases it is of very small scale. There are very few academic programs of study, although some fifty M.A. and Ph.D. theses have been accepted on psychic topics at reputable universities over the past forty years [41]. Some ten research institutes and private corporations in the United States have also authorized publications and reports in the field [42]. The extent of Eastern Bloc and Oriental efforts [43]-[54] and of classified research in this country are matters of considerable speculation on which I cannot comment with authority.

Further review of contemporary programs will be attempted in subsequent sections, following an outline of modern nomenclature and conceptual organization of the topic. In closing this historical overview, we might simply observe that in many respects the growth pattern of this field resembles that of the natural sciences in their earliest days, or perhaps even more the incubation of classical psychology, in terms of the absence of replicable basic experiments and useful theoretical models, the low level of financial support and internal professional coordination, and the low credibility in the academic establishment and public sectors. Also like those fields, the survival and early growth of psychic research can largely be attributed to the efforts of a few scholars of sufficient conviction, stature, and courage to withstand the rejection of the orthodox communities.

#### NOMENCLATURE AND CONCEPTUAL ORGANIZATION

Before turning to an assessment of contemporary research, it may be useful to specify some notation and delineation of the field, to an extent consistent with the present limited comprehension of the phenomena. First, let us agree to a global definition of "psychic phenomena" (frequently denoted by "psi" or " $\psi$ ") to include all processes of information and/or energy exchange which involve animate consciousness in a manner not currently explicable in terms of known science. Similarly, let "psychic research" imply any scholarly study of such phenomena employing scientific methodology, as opposed to any dogmatic, ritualistic, or theological approaches. Within these definitions, the field may then be roughly divided into two major categories: extrasensory perception (ESP) and psychokinesis (PK).

ESP refers generally to the acquisition of information from sources blocked from ordinary perception. Under this category are included such subdivisions as telepathy, which refers to detection of another person's thoughts; clairvoyance, which refers to contemporary perception of remote physical objects or events; precognition and retrocognition, which refer to perception of future events and events in the past not accessible by normal recollection; and animal ESP, which encompasses a variety of seemingly inexplicable capabilities, such as homing, psi-trailing, collective behavior, communication, etc.

PK (occasionally termed telekinesis, or psychoenergetics) refers to a palpable influence of consciousness on a physical or biological system. The interaction may be deliberate or spontaneous, and the energy transfer involved may range from microscopic disturbance of atomic-level processes, through

macroscopic distortion or levitation of objects, up to some very drastic "poltergeist" effects. Psychic healing and man-plant interactions would be two examples of PK in biological systems.

Note that in its major subdivision into ESP and PK, the field conforms to two of the main categories of present-day science and high technology, i.e., that encompassing the extraction, conversion, transmission, storage, and utilization of information, and that comprising the same sequence of processing of energy. Other domains of psychic research can be identified which do not fit into these major categories of ESP and PK and with which we shall not be further concerned in this article. Examples would include research into survival of death, and the family of "out-of-body experiences (OBE)," including astral projection, autoscapy, and bilocation. The following table attempts to summarize the subdivisions in a concise form.

#### Categories of Psychic Phenomena

- I. Extrasensory Perception (ESP)
  - A. Telepathy
  - B. Clairvoyance
  - C. Precognition/Retrocognition
  - D. Animal ESP
- II. Psychokinesis (PK)
  - A. Physical Systems
  - B. Biological Systems
- III. Survival
  - A. Reincarnation
  - B. Apparitions
  - C. Mediumship
- IV. Out-of-Body Experiences (OBE).

Clearly this particular arrangement is neither unique nor orthogonal. Elements of one category frequently appear in the context of another, e.g., precognitive clairvoyance; telepathic healing, etc., and occasionally an assignment is ambiguous, e.g., a particular effect may be regarded as precipitated by PK, or simply to be forecast by precognition. Notwithstanding, the table may aid in keeping the subsequent illustrations in some order.

#### PATTERN OF CONTEMPORARY RESEARCH

By its nature and heritage, modern psychic research remains rather diffuse and lightly structured, making any attempt to catalog the work by institution or laboratory, or by tracing developments of given lines of effort, rather ineffective and premature. Instead, it may be more useful to comment on the pattern of attention to this field by academic disciplines, noting the variations in emphasis, methodology, representation, and interpretation brought to bear, using specific projects only as illustrations with no implications of hierarchy or attempt at completeness. Even in this format, no recitation of specific research results or conclusions will be attempted, since these can be misleading or incomprehensible when extracted from the detailed context of their experimental arrangements and protocols. In later sections, an effort will be made to follow a few sample experiments through to their particular results and conclusions.

By far the most sustained and broadcast attention to this field has been given by a cadre of scholars with professional backgrounds in classical psychology, comprising a controversial subdiscipline termed "parapsychology." This group has tended to approach the field with the traditional psychological protocols and vocabulary, and to interpret results in the context of

their clinical, cognitive, and behavioral psychological heritages, with the natural consequence that they have concentrated mainly on the ESP category of psychic tasks, although some PK work dots their recent literature. Perhaps the most extensive class of parapsychological research has attempted to correlate psychic performance with personality variables. The age, sex, creativity, openness, hostility, extroversion, motivation, and intelligence of the participants as indices of ability to perform ESP tasks have been explored at length, and some significant correlations, most notably with positive *a priori* attitudes toward the tasks and with outgoing, creative personalities, have been reported from several laboratories. Other studies have searched for connections between psychic performance and dream recall, learning and response strategies, memory, and feedback [55]-[61].

A more aggressive style of parapsychological research has invoked a variety of altered states of consciousness in attempts to enhance psychic process. These have included various natural and traditional practices, such as sleep, meditation, and progressive relaxation [62]-[67]; more mechanical sensory inhibition strategies such as hypnosis, isolation and "ganzfeld" [66], [68]-[70]; and a few controversial efforts with drug-induced states [71]. Physiological correlates have also been sought, using conventional EEG, GSR, and plethysmographic equipment to monitor neurological, cardiovascular, and muscular response to psychic effort [35], [72]-[75]. The difficulty of obtaining successful replications of previously positive results and an observed common tendency of participant performance to deteriorate over time ("decline effect") have led to systematic study of the role of the experimenter in eliciting results, i.e., to consideration of the possible influence of the experimenter's personal attitudes, expectations, and style of interaction with his subjects, as well as the overall environmental ambience of his laboratory, on the experimental yield [76]-[81].

Despite its present recalcitrance toward more systematic study of psychic phenomena, the richly diverse, rapidly maturing parent field of psychology continues to offer an expanding array of modern methodologies and models which could be brought to bear on increasingly sophisticated study of this subject. Computer-assisted linguistic analyses; psychoneurological studies of attention, perception, and concept formation; social learning theory and similar approaches to human interactions; and the emerging formulations of transpersonal and humanistic aspects of human consciousness, all bear possible relevance to comprehension of various aspects of this ultra-difficult step-child, but at the moment, the low level of financial support, and negative professional peer pressures have discouraged such enterprise.

The involvement of physicists in psychic research, while considerably less extensive, has been no less dedicated and no less controversial. Since the days of Sir Francis Bacon, a number of noted physicists have made excursions into this field, usually to the bemusement and ridicule of their colleagues of the day. One of the most notable of these was Sir William Crookes, discoverer of the element thallium and pioneer in the physics of low pressure discharges, whose broadside professional and personal battles with the scientific establishment over this issue make entertaining, and possibly enlightening, reading [82]. Sir Isaac Newton was intensely involved in the study of alchemy, including some of its more metaphysical aspects [83], and as already mentioned, Lord Rayleigh and J. J. Thomson were active members of the S.P.R.

In more recent years the attention of physicists has influenced development of the field in at least three ways. First, their interests have focused more on the PK category of problems, i.e., the interaction of human consciousness with physical systems, to balance the predominant ESP interests of the parapsychologists. Second, more sophisticated experimental equipment than has typically been available to the psychological community has been brought to bear on the identification and correlation of very low-level physical effects. Third, the traditional theoretical physics formalisms have been directed to the proposition of various models of psychic phenomena, from whence has arisen some hope of establishing the traditional dialogue between critical experimentation and theoretical hypothesis essential to any ultimate comprehension and application of such phenomena.

Typical of the modern physicist's specific contributions to the field have been the development and application of a variety of electronic random event generators (REG) for the purpose of identifying and correlating PK abilities in human subjects [84]-[93], and similar application of magnetometers [94], torsional pendula [95], lasers [96], interferometers [97], and electronic strain gauges [98], [99] to a variety of other PK tasks. On the theoretical side, a number of applications of quantum mechanics, statistical thermodynamics, electromagnetic theory, and other formalisms to the representation of psychic process have been proposed [100]-[113], and attempts at some philosophical correlation of the phenomena with other previously or presently obscure physical processes have been suggested [114]. Again, despite the open identification of a few distinguished personalities with such efforts, a more broadly held categorical rejection of the field has inhibited much collaborative or systematic attention to it.

Up to this time, the involvement of engineers with psychic research has been very recent, very sparse, and very much along the lines of the experimental physicists. Beyond our own program, which will be outlined in some detail below, I am aware of only a very few engineering laboratories addressing any aspects of the field in any substantial and deliberate way [115]. These have so far tended to concentrate on applied physics types of experimentation and on aspects of information processing, rather than on more empirical technological applications.

Another community of scholars to influence the pattern of psychic research comprises the statisticians and other applied mathematicians and logicians who have been concerned with the proper evaluation and interpretation of the research data. In the absence of any experiments displaying rigid causal replicability, all of the inferences and hypotheses about psychic phenomena have necessarily been based on either anecdotal or statistical evidence. The former defy any systematic representation; the latter are vulnerable to alternative interpretations and hence to impressionistic bias and argument.

Early in the emergence of mathematical statistics as an integral discipline, S. S. Wilks found himself involved in a controversy over the validity of the statistical procedures of early psychic researchers, and published some recommendations for methods that could be applied to telepathy experiments [116]. Since that time, much of the commentary from the critical community has addressed perceived flaws in the statistical methodology underlying the experimental evidence [117], [118], and the advocate community has reacted by paying disproportionate attention to this aspect of their logic. Most of the encyclopaedic references in the field contain



substantial components on the statistical methods [119], and the leading journals regularly display intense dialogues on specific statistical issues [120]-[124]. At least one of these journals routinely refers all articles submitted for publication to a consultant statistician as a part of their review process. A few illustrations of the statistical questions that can arise in psychic experiments appear in the detailed examples presented below.

A number of other disciplines have played roles in the evolution of the study of psychic process and continue to contribute, albeit somewhat more peripherally. A succession of philosophers, from Aristotle through James and Bergson to C. D. Broad in the present era, have mused on these topics [21]-[25], [125]-[129]. The intersections of the field with anthropology, theology, and history have been approached from many perspectives ranging from aesthetic to analytic, and from dogmatic to scholarly [130]-[134]. Its relevance to the study and practice of medicine has been an enduring and intense debate, focusing in the present day on the propriety and efficacy of holistic health strategies and psychic healing. Isolated instances of interest on the part of chemists, biologists, geologists, and archaeologists can be found, and the application of psychic techniques in criminology and law enforcement, while less rigorous than most of the academic efforts, contributes further anecdotal evidence to the overall data base. In the arts and humanities, the topic continues to provide stimuli for a variety of creative compositions.

Still other areas could be cited, but these become progressively more satellite than central to the task of this paper. Rather than pursuing this disciplinary survey further, it seems preferable next to focus in greater detail on a few contemporary studies that can serve to illustrate more specifically the bizarre phenomena, the awkward and tedious protocols, and the unconventional theoretical concepts that arise in this class of research. Although these will provide a better sense of the status of the field than any attempt to summarize results from the diffuse multidisciplinary pattern of effort sketched above, one general assessment may be useful at this point. Namely, throughout all of the work just skimmed, and that sharpened somewhat below, I am aware of no reputable investigator who has claimed, let alone demonstrated, any psychic experiment approaching classical scientific replicability. What have been put forward are a varied assortment of observations, currently inexplicable in terms of established science, which display certain common phenomenological and psychological features, and which could have substantial implications for basic physical theory and ultimate practical applications. The following examples are presented in that spirit.

#### PSYCHOKINESIS

The first group of experiments selected as more detailed illustrations of contemporary psychic research are drawn from the general subdomain of PK. As defined above, this broad category of purported psychic phenomena encompasses the possible influence of human consciousness on the behavior of physical or biological systems or processes, and comprises several loosely related classes of effect characterized by different scales of energy, forms of manifestation, replicability, and statistical behavior. Confining attention to interactions with physical objects or systems, the most popularly publicized class features the deformation, levitation, or other macroscopic disturbance of objects, as commonly propounded by professional performers, mediums, and various Eastern practitioners [135]-[137]. Al-

though a number of serious efforts have been made to submit such demonstrations to rigorous scientific testing, these have tended to yield only equivocal confirmations, fodder for the critical community, and some embarrassment and frustration to the investigators.

Of a yet more bizarre nature are the family of very rare and spectacular "poltergeist" effects, more technically termed "recurrent spontaneous psychokinesis" (RSPK), wherein are reported specific major events of levitation, vibration, teleportation, and breakage of a wide range of objects, a variety of acoustical and electromagnetic phenomena, and various optical aberrations [138], [139]. For years these phenomena were naively attributed to manifestations of the spirit world, or return of the dead to "haunted" houses, and inspired countless horror movies and pulp-magazine articles. Recently, some order has been brought to this weird business by systematic surveys of documented poltergeist cases undertaken by A. R. G. Owen, W. G. Roll, J. G. Pratt, and others [138]-[142]. In one of these surveys, 116 cases of reported poltergeist activity, ranging back to the year 1612, were re-examined. Of these, 92 were found to be associated with particular individuals living in the affected dwelling, most of whom were adolescents, and most of whom were affected by some neurological/emotional ailment, most commonly epilepsy. Often a precipitating traumatic event could be identified which seemed to initiate the activity, after which the general pattern involved a period of relatively mild precursor events, a sequence of major disturbances, and a period of "after shocks," extending as much as several weeks beyond the main events. Controlled experimentation on poltergeist phenomena has proven virtually impossible because of their infrequent and unpredictable occurrence pattern and because of the delicate physiological and emotional situations prevailing in most cases, which have taken precedence over the technical investigations. Nevertheless, these processes have retained some fascination because of the magnitude of the energy transfer involved and because of their apparent correlation with specific types of individuals and neurological disorders.

The most systematic and persuasive studies of PK, however, have dealt with much more modest scales of physical disturbance, in some cases reaching down to the atomic level. This somewhat more viable domain has been addressed by numerous investigators in various ways, but basically one of two strategies is followed. In one approach, relatively simple physical systems are employed—mechanical, electrical, optical, thermal, etc.—each of which involves a particular component or process that is ultra-sensitive to disturbance. The experiment is arranged to signify such disturbance by a relatively large change in some display which provides feedback indication to the operator, much in the spirit of a biofeedback instrument, and simultaneously to provide some form of permanent data record. Examples of this class of experiment would include the use of magnetometers, torsional pendula, optical interferometers, electronic strain gauges, glow discharges [143], and sensitive thermistors [144].

In the second approach, attempt is made to distort the normal statistical patterns of various random physical processes on either a microscopic or macroscopic scale. In a sense, these experiments deal with energy rearrangement within the systems, i.e., with their information content or entropy, rather than with energy transfer to the system *per se*. The earliest versions of this class employed dice, or other simple mechanical implements of well-known statistical behavior [37], [92], [145]-[148], but more recent studies have tended to employ more sophisti-

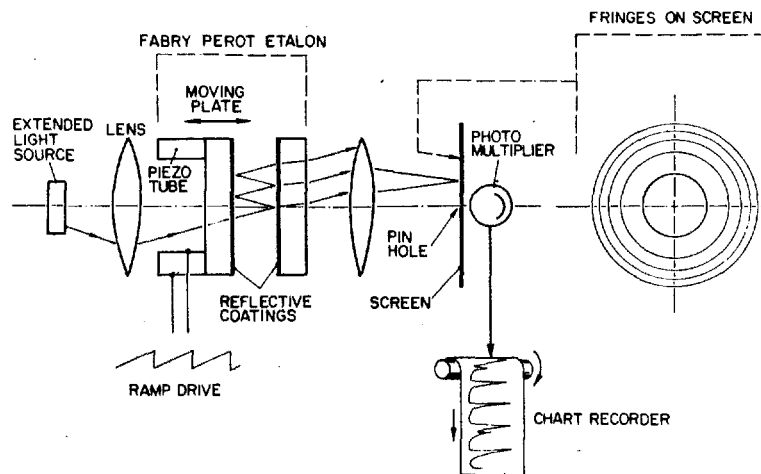
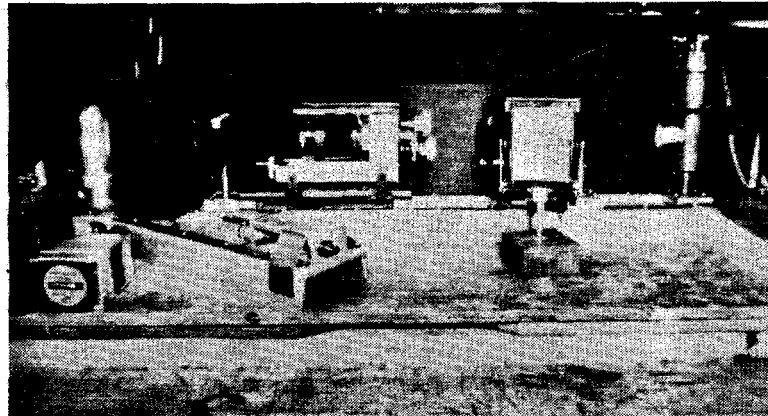

Fig. 1. Photograph and schematic of Fabry-Perot interferometer.

cated apparatus, such as electronic REG's like those described in detail below.

Although the first two categories of PK feature more dramatic effects and thus have enjoyed greater popular attention, the smaller scale phenomena seem more amenable to controlled experimentation and theoretical interpretation, and the remainder of this section deals only with such. Perhaps the most efficient means of elaborating on this type of research would be to review briefly the spectrum of such experiments in progress in our own laboratory, and then to display and attempt to interpret data from one of them. In so doing, we intend no neglect of other work noted in the references, but simply deal from greater familiarity.

As examples of the first class of low-level PK experiment mentioned above, we have in operation a Fabry-Perot optical interferometer, a dual-thermistor bridge, and a photoelastic strain detector. In the interferometer experiment, shown in the photograph and schematic of Fig. 1, a Coherent Optics Instrument #360-370, using a diffuse sodium lamp as source, is adjusted to produce circular fringes on a screen visible to the operator (Fig. 2). Small changes in the separation of the interferometer plates cause the fringes to migrate radially inward or outward. By visual observation of the fringe movement, plate motions of less than 0.1 wavelength can be readily detected. Via a pinhole in the screen, the brightness of the central fringe is recorded by a photomultiplier/chart recorder system at an order of magnitude higher sensitivity, thereby preserving quantitative output data while the operator simultaneously sees an attractive optical display of his progress for use as feedback.

The task of the operator is to cause the migration of the fringe pattern in a stated direction relative to the normal baseline drift of the instrument. The protocols involve rigid control and monitoring of the environment of the instrument and surrounding laboratory, and the interspersing of baseline responses with active PK efforts obtained under otherwise identical conditions, including the position of the operator and any other personnel relative to the instrument. In pilot studies with this device, a variety of fractional-fringe responses were observed, using several different operators and various initial interferometer settings. A more formal procedure has since been developed which provides more precise conditions for an ongoing series of trials. In this protocol, the central fringe is set initially on a maximum gradient position between a bright and dark fringe, and its progress monitored for subsequent periods of baseline or PK effort. Encouragingly replicable data have been obtained from a number of different operators, in the form of chart recordings of 5-min PK trials with interspersed 5-min baseline drifts of the instrument. Using computerized graphic, regression, and spectral analyses of the data, it is possible to discern characteristics in the hierarchy of trace derivatives and the Fourier spectra which, while not definitive, display certain recurrent features [97]. No physical interpretation has been attempted other than to acknowledge that the observed fringe migrations could also be indicative of slight changes in the index of refraction of the air in the plate gap or in the wavelength of the light source, as well as of a displacement of the plates.

The dual-thermistor experiment comprises a much more sensitive version of a multiple-thermistor arrangement on which

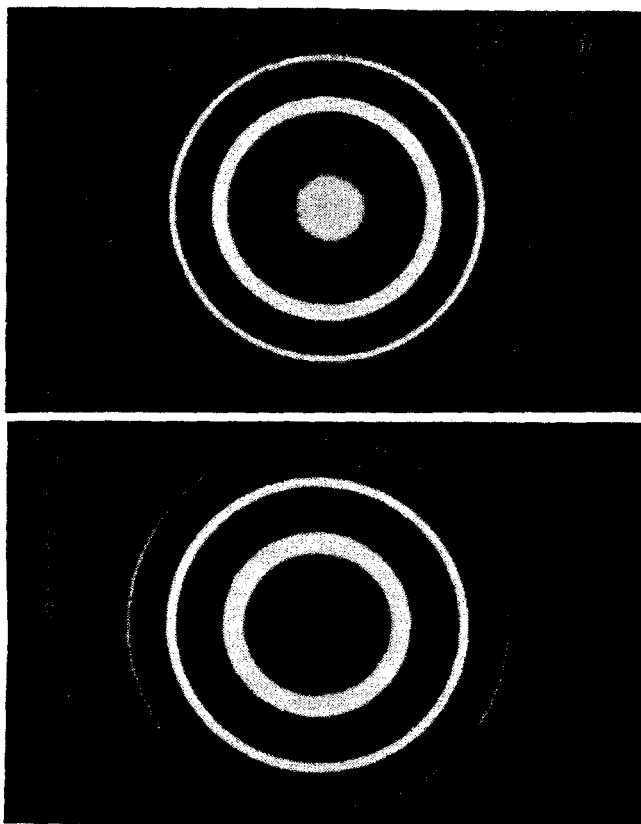

Fig. 2. Interferometer fringe patterns.

As shown in Fig. 3, two Omega Engineering thermistors, Model UVA 3254, each with its own electronic bridge and voltage source, are connected differentially to a Tektronix 1A7A oscilloscope preamplifier and to a visual feedback display. With suitable ground planes and cable shielding, sensitivities greater than 0.001 K are obtainable, and by subtracting the two output signals the major portion of spurious electrical and mechanical interference is eliminated. The effects of ambient thermal variations in the laboratory are essentially excluded by enclosing each of the thermistors in identical Pyrex flasks immersed in a large liquid reservoir, in which configuration the undisturbed system exhibits stable baselines over long periods of time. Using the same interspersed baseline protocol as in the interferometer experiment, the task of the operator is to achieve an increase in the reading of one thermistor with respect to the other or in some more subtle fashion to alter the PK response relative to the baseline. Some such effects have indeed been observed, but little systematic data have so far been accumulated on this experiment.

Also in a preliminary stage is an experiment to monitor internal strain in a solid specimen via photoelastic optical techniques. Several studies have been reported on the PK deformation of solids, but most of these have employed conventional engineering strain gauges or microacoustic sensors as detectors [98], [99], [135], [149], [150], both of which require substantial interface electronics before a feedback signal reaches the operator, leaving unclear the role of the sensor in any possible PK influence. Although less sensitive than the electronic methods, photoelastic techniques have the advantage of relating the operator more directly to the sensitive element of the experiment via an attractive optical fringe pattern much like that of the interferometer (Fig. 4). This equipment and technique may also be applied to a sensitive levitation experiment wherein

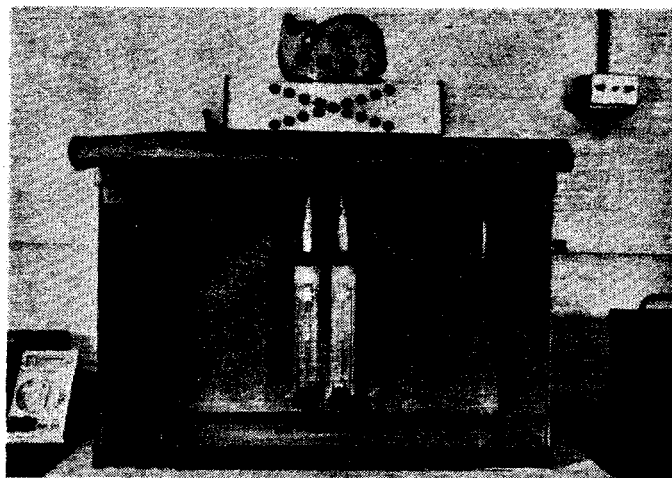

Fig. 3. Dual-thermistor apparatus.

the object is suspended on a photoelastic lever arm of suitable dimensions.

Within the second category of low-level PK experiment, we are employing or are now constructing several devices based on random physical processes, some macroscopic in scale, others deriving from atomic-scale processes. The largest of these involves a 6 X 10 ft apparatus, shown in Fig. 5, which drops some 10 000  $\frac{3}{4}$  in spheres through a "quincunx" array of 336 nylon pegs in about 12 min. As a consequence of the multitudinous collisions with the pegs and with each other, the spheres are dispersed into a good approximation of a Gaussian distribution as they fall into 19 collecting compartments at the bottom. The goal of the operator is to distort the distribution in some prescribed fashion to a significant degree compared to empirical baseline experience. Photodiode counters mounted in funnels at the entrance to each bin provide real-time digital displays of the bin populations to supplement the more qualitative feedback of the growing ball stacks seen by the operator and to provide quantitative data for on-line statistical analysis. Fig. 5 shows a typical baseline distribution for this device and a distorted distribution obtained in a particular PK effort. Full statistical analysis of the significance of any particular achieved pattern is a challenging problem in its own right, since it must deal with a combination of 19 bin populations, each of which has its own empirical baseline mean and standard deviation, all constrained by total ball count.

A somewhat similar experiment, not yet refined, employs a device which allows small metallic or dielectric spheres to bounce on an optically flat, precisely horizontal circular plate of glass, which is oscillated by a vibration coil at frequencies from 10 Hz to 20 000 Hz. In the absence of any external disturbance, a sphere started at the center of the plate executes a random walk toward the outside edge, arriving with equal probability at any azimuth. Since the sphere may make as many as  $10^5$  collisions in the process, it is vulnerable to statistical distortion of its trajectory and consequent terminus. The task of the operator is preferentially to direct the sphere to a prescribed terminal quadrant.

In an attempt to intervene with a random physical process at the atomic level, we have constructed a large glow-discharge device whose luminous patterns are indicative of the mean free path of the current-carrying electrons against inelastic excitation collisions with the background gas. This device, shown in Fig. 6, presents a 36-in X 2-in diam cylindrical glow marked by a sequence of bright and dark zones along its positive column

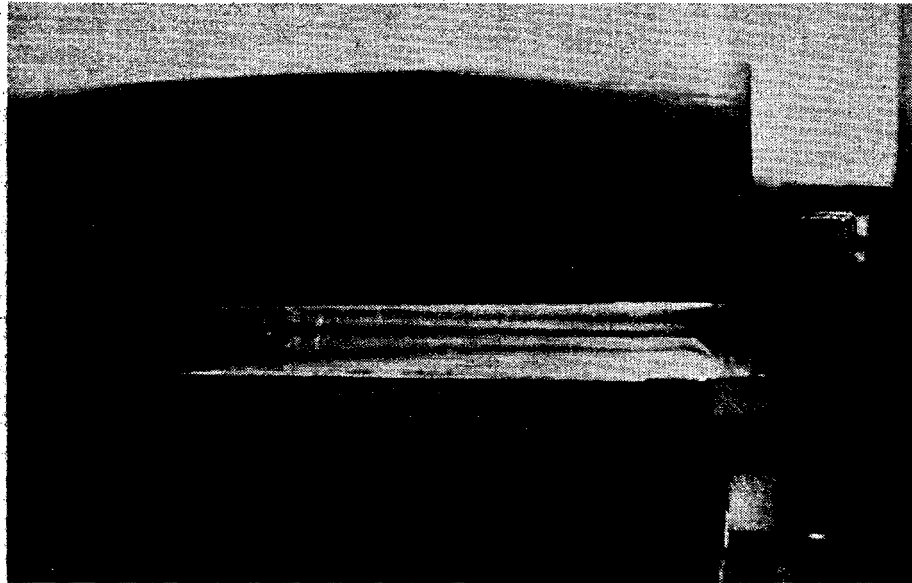

Fig. 4. Photoelastic stress pattern.

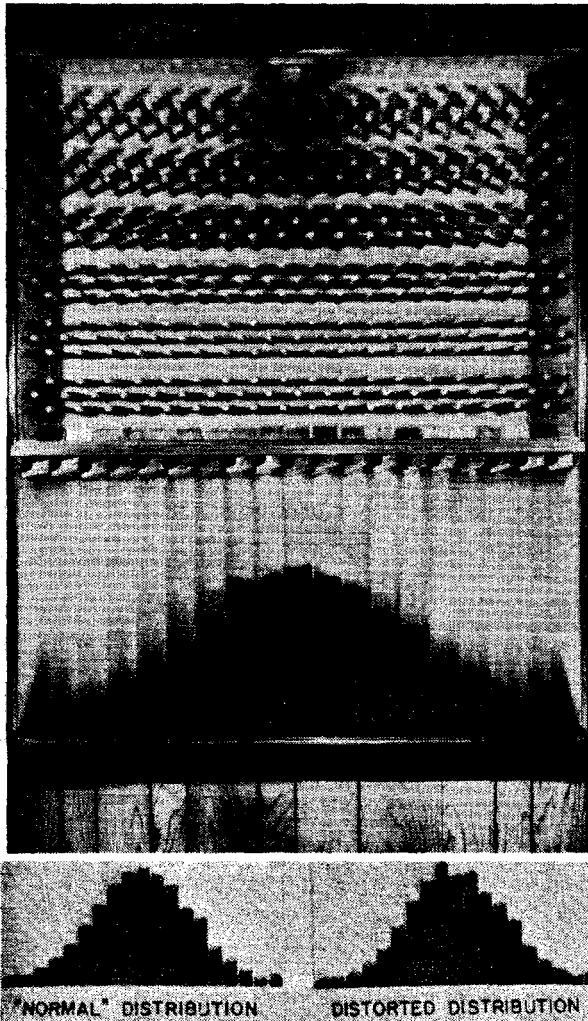

Fig. 5. Gaussian analog device and distributions.

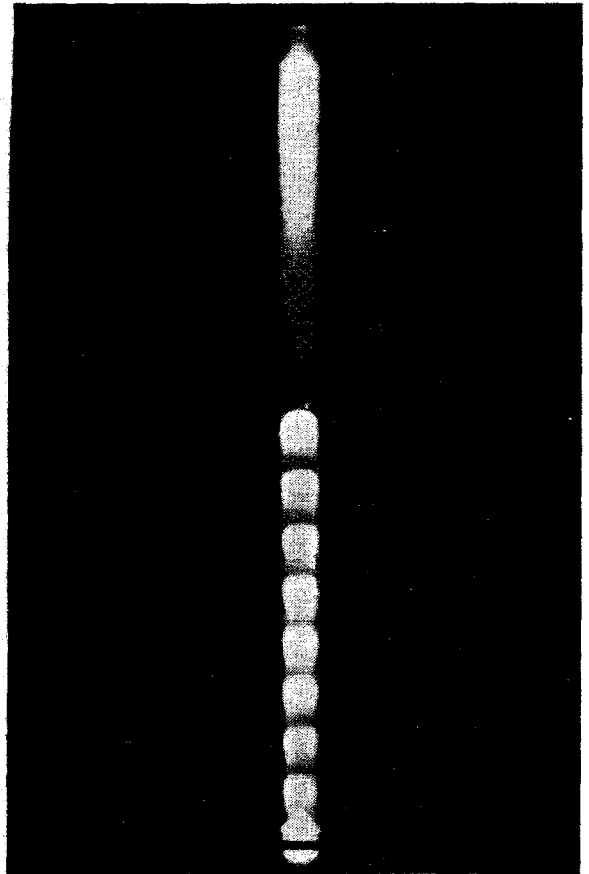

Fig. 6. Glow discharge experiment.

typical of dc discharges in a given range of gas pressure and terminal voltage. The number and locations of these striations are sensitive to the electron inelastic mean free path, which in

turn depends on the gas type and density, the electron temperature, and the local electric field. Striation position is monitored by photoelectric detectors, and the goal of the operator is to expand or contract the pattern on demand, to a significant extent compared to the normal background jitter and drift. Protocols are much the same, output data take the same general form, and are analyzed by the same algorithms as in the interferometer and photoelastic experiments.

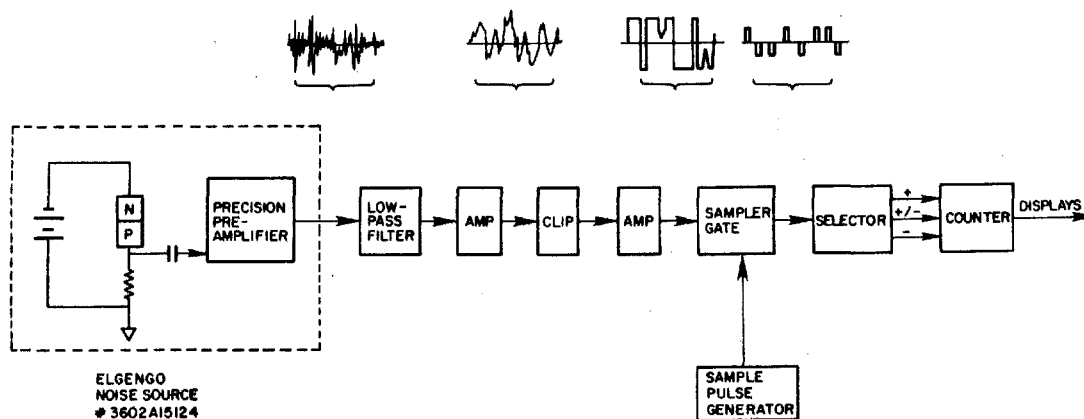

Fig. 7. Functional diagram of REG.

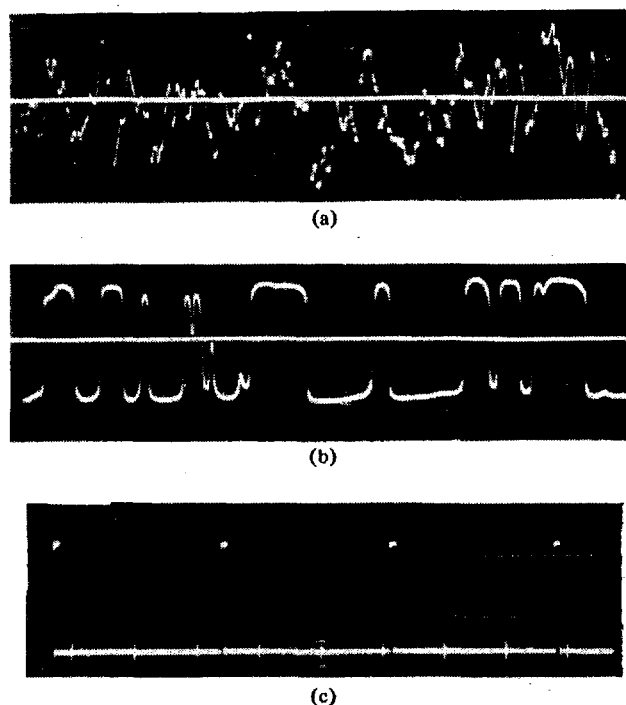

Fig. 8. REG waveforms: (a) Filtered noise. (b) Clipped noise. (c) Sampling pulses.

A number of other atomic-scale random system PK experiments are under consideration, design, or construction, involving such processes as information storage on a microelectronic chip, the spontaneous decay of phosphorescent surfaces, laminar to turbulent transition in a fluid stream, atomic and molecular resonators, and resonant acoustical or electrical cavities, but none of these is far enough advanced to merit description here. Rather, we shall concentrate for the remainder of this section on a more detailed presentation of our most serviceable experiment, and the one on which we have the largest data base, the electronic REG.

#### RANDOM EVENT GENERATOR EXPERIMENTS

REG's have been the most widely used and most productive facilities for experimentation with low-level PK. Although a broad variety of such devices exist, most involve four conceptually and functionally separable components: an electronic noise source; a sampling system which examines the noise at pre-

scribed intervals and prepares an output pulse train corresponding to the samples thus obtained; a system which analyzes the pulse train in accordance with preset instructions and prepares suitable output for a feedback system; and the feedback display itself, which informs the operator of the results of the sampling process.

The particular version we have employed utilizes a packaged commercial noise source module based on a solid-state junction and precision preamplifier (Elgenco Model 3602A15124), but modules employing radioactive decay units or glow discharges can be readily substituted. This source produces a random noise spectrum up to several megahertz, which our logic circuit first filters to a flat spectrum from 50 to 20 000 Hz, then amplifies and clips to the flat-topped profile shown in Figs. 7 and 8. This is then sampled by a regular train of gate pulses, yielding a corresponding random succession of positive and negative output pulses indicative of the sign of the noise at the time of sampling, and these are then counted. Since the average time between

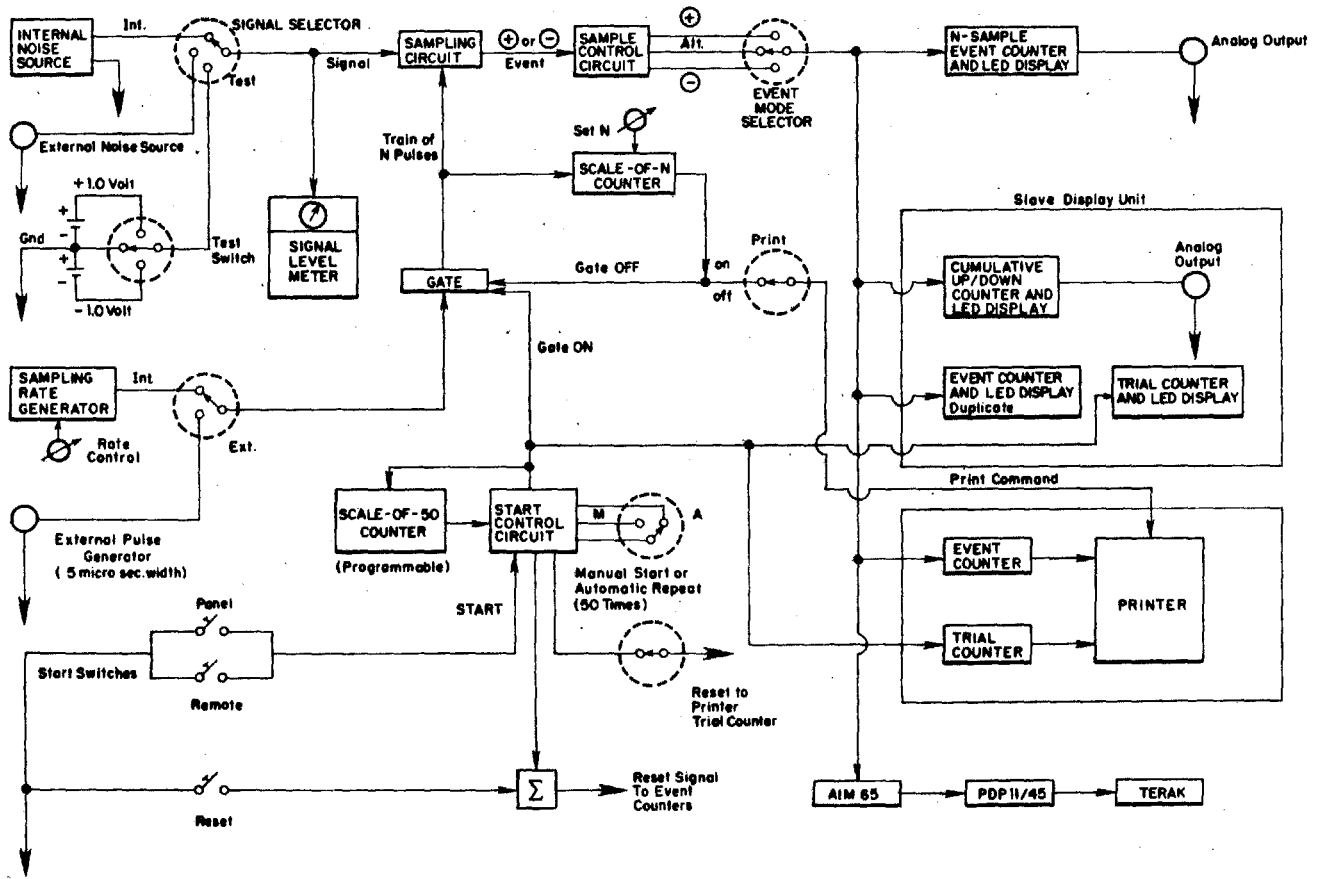

Fig. 9. Electrical schematic of REG.

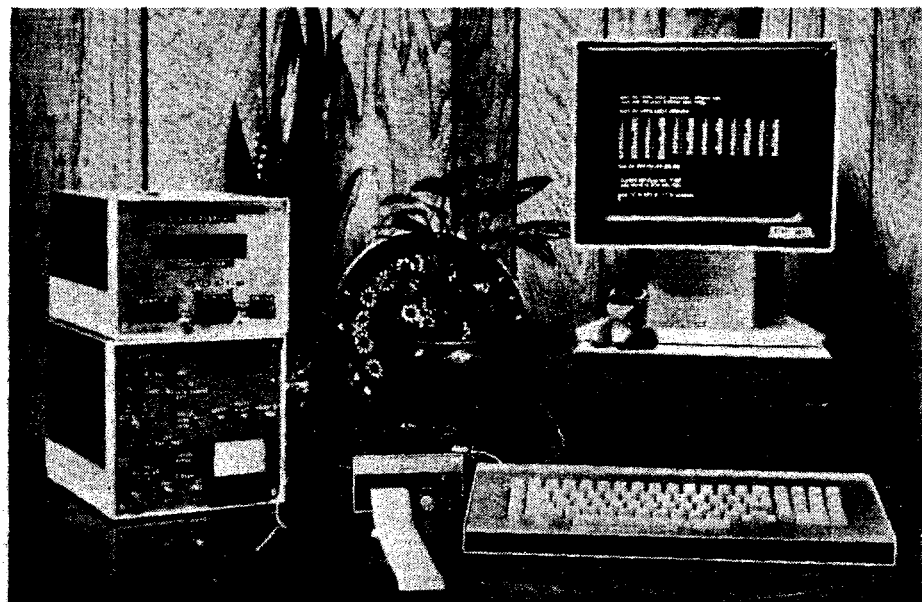

Fig. 10. REG arrangement.

zero crossings of the clipped noise waveform is about 30  $\mu$ s, sampling rates to about 15 000/s can be tolerated with statistical independence.

The full functional array is sketched in Fig. 9, and a photograph of the boxed units in Fig. 10. By panel setting the sampler may be instructed to take "trials" of 100, 200, or 2000 samples, at a frequency of 1, 10, 100, 1000, or 10 000/s. The

counting system may be set to count only positive pulses, only negative pulses, or to alternate positive and negative counting on successive samples. The alternating positive/negative mode effectively factors out any systematic bias in the noise source, and is the mode employed in all the experiments reported here. The counting results are displayed by LED arrays tracking both the running count of each trial and the concurrent mean rela-

TABLE I  
REG 200-SAMPLE DATA SUMMARY

Series	Instr.	No. Trials	Mean	Std. Dev.	t-score	$P_t$	$n_+/n_-$
REG I	B.L.	12 000	100.009	6.994	0.144	0.443	5678/5611
	PK <sup>+</sup>	4 550	100.264	7.037	2.528	0.006	2230/2056
	PK <sup>-</sup>	3 850	99.509	7.063	-4.313	10 <sup>-5</sup>	1716/1926
	Δ PK	8 400			4.890	5 × 10 <sup>-7</sup>	
REG II	B.L.	2 500	100.033	6.875	0.239	0.406	1188/1179
	PK <sup>+</sup>	1 950	100.247	6.849	1.590	0.056	916/919
	PK <sup>-</sup>	1 800	99.597	6.775	-2.526	0.006	797/902
	Δ PK	3 750			2.920	0.002	
REG III	B.L.	3 500	99.977	7.013	-0.193	0.424	1658/1655
	PK <sup>+</sup>	2 400	100.227	6.821	1.634	0.051	1150/1086
	PK <sup>-</sup>	2 600	99.736	7.026	-1.918	0.028	1192/1270
	Δ PK	5 000			2.507	0.006	
Σ REG I	B.L.	18 000	100.006	6.981	0.115	0.454	8524/8445
II	PK <sup>+</sup>	8 900	100.250	6.938	3.403	3 × 10 <sup>-4</sup>	4296/4061
III	PK <sup>-</sup>	8 250	99.600	6.989	-5.203	10 <sup>-7</sup>	3705/4098
	Δ PK	17 150			6.107	5 × 10 <sup>-10</sup>	
REG Ia	no B.L.						
	PK <sup>+</sup>	2 150	100.206	7.091	1.340	0.088	1059/993
	PK <sup>-</sup>	2 100	99.945	6.937	-0.365	0.358	954/1019
	Δ PK	4 250			1.213	0.113	
REG IIa	B.L.	5 000	100.186	6.974	1.882	0.030	2367/2337
	PK <sup>+</sup>	2 000	100.117	7.041	0.746	0.228	955/950
	PK <sup>-</sup>	1 750	99.941	6.898	-0.360	0.359	803/839
	Δ PK	3 750			0.772	0.220	
Σ REG I	B.L.	23 000	100.045	6.980	0.978	0.164	10891/10782
Ia							
II	PK <sup>+</sup>	13 050	100.223	6.979	3.644	10 <sup>-4</sup>	6310/6004
IIa							
III	PK <sup>-</sup>	12 100	99.709	6.968	-4.596	2 × 10 <sup>-6</sup>	5462/5956
	Δ PK	25 150			5.828	3 × 10 <sup>-9</sup>	

tive to a preset origin and are permanently recorded on a strip printer. For most of the experiments described below, an AIM-65 microprocessor interface is also utilized to insert the trial-count data on-line into processing routines supported by a TERA Model 8510 used as a terminal and PDP 11/45 and VAX 750 employing a UNIX operating system programmed in C language. All of the sampling, counting, and display functions can be simply checked by referring them to an internal or external calibrated pulse train generator.

The device also has a manual/automatic option, whereby it will either collect its trial samples only when a panel switch or parallel remote switch is pushed, or it will repeat that process for 50 trials automatically once activated by the switch. The operator thus has the option of triggering each trial or of initiating a repetitive flow of 50 such trials with no further intervention.

The experiments reported here were performed by a single operator, seated in front of the device with the remote initiation switch in hand and the LED count indicators and TERA terminal display visible. This operator attempted, on instruction or volition, to distort the trial counts either toward higher or lower values. The several options of sampling number, sampling frequency, +/- polarity, and manual/automatic sequencing were variously determined by random instruction, operator preference, or experimental practicality, and recorded before the beginning of each trial. Clearly, the full matrix of such possibilities could not be explored, and for our first sequence of

experiments only 200-sample trials were used, at 100 or 1000 counts/s, all counted in the +/- alternating mode. The automatic/manual and high/low options were more thoroughly tested, in both the volitional and instructed choice modes.

Fifty trials of the 200-sample units comprised a test run, and data from these were processed individually and in many concatenations via a statistics package in the UNIX system developed specifically for this task. Calculated were the mean, standard deviation, range, kurtosis, skew coefficient, z-score, t-score,  $\chi^2$  goodness-of-fit with both 8 and 16 degrees of freedom, and the corresponding one-tailed probabilities against chance of the last four measures. Applied to earlier and ongoing baseline data, this analysis confirmed that in undisturbed operation this REG conforms very well to a Gaussian approximation to the appropriate full binary statistics.

The major portion of the results listed below comprised three separate experimental series, extending over fifteen months, labeled REG I, REG II, and REG III, respectively. All other data acquired under slightly less formal conditions of protocol during this period, included for completeness, are grouped under two other series, labeled REG Ia and IIa, respectively. Details of these series protocols, calibration tests, and their individual results are available in the reference [93]. All told, over 25 000 active PK trials were obtained, corresponding to more than 5 000 000 binary events.

Table I summarizes all of the baseline and PK data acquired during these five experimental series. A total of 23 000 base-

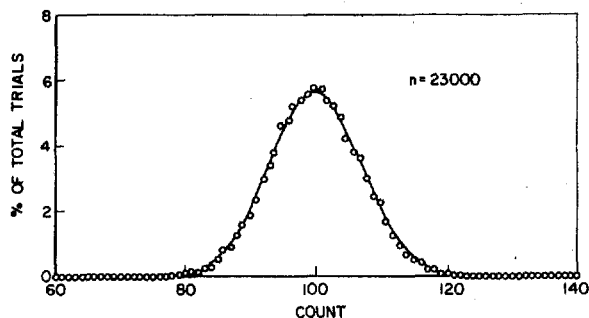

Fig. 11. REG 200-sample baseline data on theory.

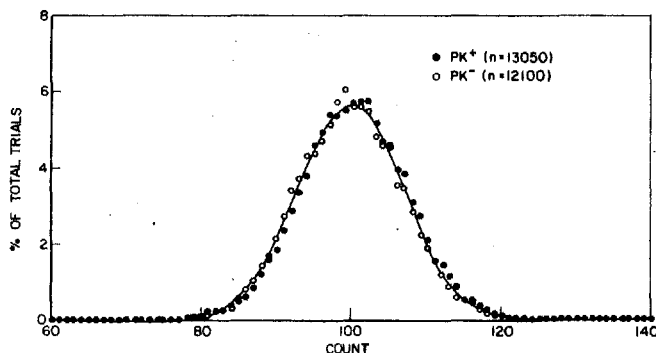

Fig. 12. REG PK<sup>+</sup> and PK<sup>-</sup> 200-sample data on theory.

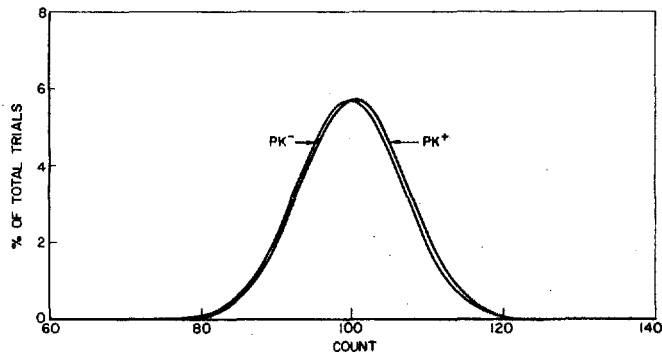

Fig. 13. REG PK<sup>+</sup> and PK<sup>-</sup> 200-sample data fitted curves.

line trials were taken under a variety of conditions before, during, and after the active PK trials. Their overall mean was 100.045, and their standard deviation 6.980, compared with the values of 100.000 and 7.071 predicted by the theoretical Gaussian approximation to the appropriate binary statistical distribution. As shown in Fig. 11, the frequency of count distribution conformed very well with the theoretical curve.

The results of the PK trials are also presented in Table I and in Figs. 12 and 13. Briefly, the 13 050 high-instruction trials, denoted PK<sup>+</sup>, yielded a mean of 100.23 and a standard deviation of 6.979; the 12 100 low-instruction trials, denoted PK<sup>-</sup>, yielded a mean of 99.704 and a standard deviation of 6.968. The one-tailed probability of chance occurrence of the former, computed from *t*-score, is about 10<sup>-4</sup>; of the latter, about 2 × 10<sup>-6</sup>. The combined probability of the split, i.e., of this total "direction-of-effort" success, denoted ΔPK, is about 3 × 10<sup>-9</sup>. (A number of more elaborate statistical measures have been applied to these data; the results are not qualitatively changed thereby.)

As is evident from Figs. 12 and 13, and as is verified by the

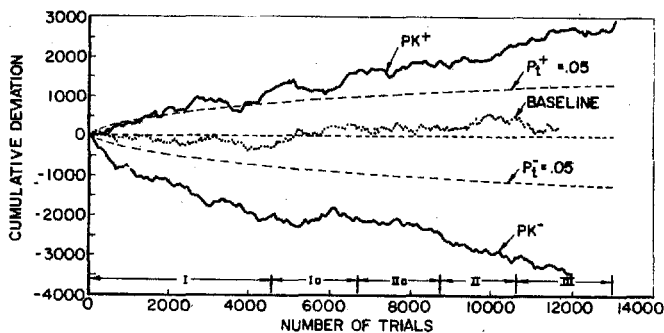

Fig. 14. REG cumulative deviations of PK<sup>+</sup> and PK<sup>-</sup> 200-sample data.

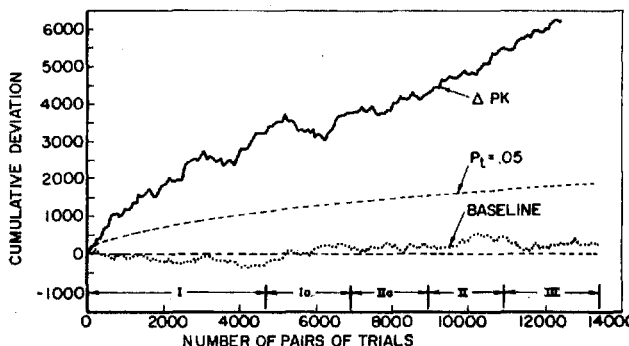

Fig. 15. REG cumulative deviations in direction of effort of all 200-sample data.

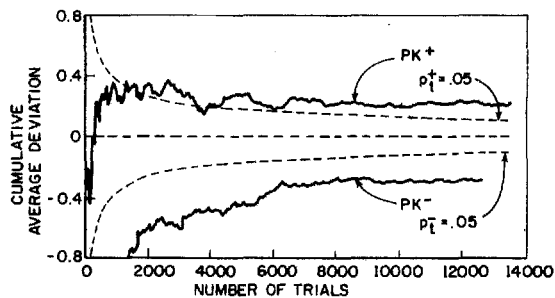

Fig. 16. REG cumulative average deviations of PK<sup>+</sup> and PK<sup>-</sup> 200-sample data.

more detailed statistical tests performed, no significant distortion of the frequency-of-count distributions other than the shifting of the means has occurred. In other words, the observed effect is to shift the total distributions intact, rather than to distort any of their higher moments significantly. This result clearly has felicitous implications for this class of experimentation, since it allows much simpler and faster data collection and analysis than might otherwise have been anticipated.

It is illustrative to exhibit the overall data behavior via graphs of the cumulative deviation of the trial score means versus the accumulated data base. Fig. 14 shows such a representation for the total data pool plotting PK<sup>+</sup>, PK<sup>-</sup>, and baseline data with reference to cumulative 0.05 confidence levels. Fig. 15 uses a similar representation for compounding the PK<sup>+</sup> and PK<sup>-</sup> data in a "direction of effort" cumulative deviation. (Had REG Ia and IIa been excluded from these data, the overall slopes would have been slightly more severe and uniform.)

Alternatively, the cumulative data may be presented in terms of the progressions of the average deviations from the theoretical mean, as shown in Fig. 16, where the stochastic variations



of the small data bases are seen to damp out to well-defined terminal values after several thousand trials.

The PK<sup>+</sup> and PK<sup>-</sup> effects also manifest themselves in terms of the number of trial means recorded above and below the theoretical value. As displayed in Table I, PK<sup>+</sup> efforts were generally characterized by an excess of trial means above 100.00 and PK<sup>-</sup> efforts by an excess below. The total concatenations in these terms are significant at a level of 0.003 for PK<sup>+</sup> and  $3 \times 10^{-5}$  for PK<sup>-</sup>.

The ensemble of results acquired in these experiments display certain instructive general features:

1) The importance of accumulating very large data bases when dealing with such marginal phenomena is emphasized by the relative scales of the statistical vagaries and the broader systematic trends in Figs. 14-16. Although the trends are established early in the data collection sequence, unambiguous departures from the accumulated vagaries of chance behavior occur only well into the total 25 000 trial, 5 000 000 bit, sequence.

2) Over this large a data base, there arises some quantitative statistical regularity in the PK process, epitomized by the mean slopes of the cumulative deviations in Figs. 14 and 15 and by the terminal values of the average deviations in Fig. 16. Traced back to the elemental binary samples, these values imply directed inversions from chance behavior of about one or one and a half bits in every one thousand or, alternatively, of 0.2 or 0.3 bits per trial.

3) The differences between the somewhat larger values for the PK<sup>-</sup> deviation and the lesser values for PK<sup>+</sup> are only marginally significant on this data base, but prevail rather uniformly throughout all the test series. The suspicion that these reflect some subtle bias in the REG itself is not supported by the baseline data, which concatenate to a grand mean very slightly above the theoretical value.

One of the primary goals of such controlled PK studies at this early phase in the understanding of the phenomena is to develop experiments of sufficient yield and replicability that various parametric correlations may be systematically explored, thereby hopefully separating the consequential from the inconsequential factors. The experiments outlined above hold some promise of serviceability for this purpose, but a great deal of data will need be accumulated to establish any such correlations. Four classes of parameters could be considered: those associated with the experimental equipment; those associated with the operator's physiological and emotional characteristics; those associated with the operator's technique; and various environmental factors not directly associated with either. So far we have accumulated only small amounts of data from other operators, and given the general indication #1 above regarding the importance of large data bases, we can make no statement about the generality or peculiarity of our principal operator's performance. Similarly, we have attempted no systematic variation of external environmental factors, and although test times, dates, durations, and laboratory temperature, pressure, and humidity have been routinely recorded, we cannot comment on the importance of this category of parameter.

On the matter of operator technique, it should first be re-emphasized that the sole formal difference between the PK<sup>+</sup> and PK<sup>-</sup> trials is the specified intention of the operator to influence the device to generate numbers in the assigned direction. No other variation in protocol is permitted, save those subjective differences in psychological attitude the operator chooses to invoke. Although no records of such aspects were kept,

this operator, who claimed no special talent for this or any other psychic task, reported that any conscious variations in psychological strategy, such as focus of visual attention, or intensity of concentration or desire, did not appear to have any evident effect on the yield. Similarly, differences in the laboratory ambience, such as the lighting level, background noise, or peripheral presence of other persons, did not seem to influence this operator's performance. When queried about any impressionistic sense of the interaction process, the operator alluded to a "resonance or identification with the system, leading to a loss of self-awareness similar to that experienced in a game, a movie, or some creative occupation." Clearly this class of parameter will be the most difficult to specify and correlate, and we are far from any definition of its mechanisms.

With respect to experimental options on the equipment parameters, we can make very limited explorations with the acquired data base. Briefly, binary correlations of the data for the 100/1000 counting rate option, for the volitional/instructed direction of effort, and for automatic/manual sampling give little indication of importance of such factors in the overall performance. Each category shows clear and significant separation of the means for the PK<sup>+</sup> and PK<sup>-</sup> efforts, with little to choose between the *t*-scores for the various categories. Thus, at least for the data base at hand, the process seems insensitive to these particular experimental parameters.

We have also attempted correlation in terms of the trial-number sequence. With cognizance of the ubiquitous "decline effect" which is reported over a broad range of psychic experimentation, we have prepared an algorithm which cross-concatenates from the data base all scores achieved on the first trials of the experimental run, all achieved on the second trials, etc., up to the fiftieth, and arrays those fifty means in a graphical form. The results show little systematic profile of yield versus trial number. A similar exercise has been performed to cross-concatenate the data by run-number over the various series to search for a decline effect on that larger scale, but again no significant correlation is found within this data base.

The most extensive parametric exploration attempted to date was motivated by the apparently fundamental question implicit in general conclusion 2) above, i.e., whether the magnitude of the observed effect correlates with the total number of bits processed, or with the number of trials. To explore this aspect, the same operator has performed a second ensemble of experimental series totaling 25 000 trials, all consisting of 2000-sample bits rather than 200. As before, various combinations of the automatic/manual and volitional/instructed modes were employed, but to speed data acquisition and reduce the operator's tedium, only the 1000/s counting rate was used. This, coupled with the more elegant data processing capabilities that had evolved over the preceding experiments, allowed this sequence to be completed in less than six months.

The results of this effort, as presented in Table II and Figs. 17 and 18, are curiously ambivalent. As before, there is clear and significant separation of the means of the PK<sup>+</sup> and PK<sup>-</sup> efforts, and the baseline is well behaved. As could be anticipated from the larger standard deviation of the 2000-bit data, the cumulative traces display larger statistical fluctuations and require a larger number of trials to settle toward well-defined terminal values. To the quantitative precision allowed by this data base, these terminal values appear not to endorse any simple bit-level hypothesis in that they fail by a factor of 6 or 7 to achieve the one or one and one-half bits per thousand

TABLE II  
SUMMARY OF REG 2000-SAMPLE DATA

Instr.	No. Trials	Mean	Std. Dev.	t-score	$P_t$	$n_+/n_-$
B.L.	12 500	1000.016	21.879	0.079	0.468	6157/6088
PK <sup>+</sup>	12 200	1000.380	21.906	1.914	0.028	6092/5897
PK <sup>-</sup>	12 800	999.569	22.005	-2.216	0.013	6218/6351
Δ PK	25 000	—	—	2.920	0.002	

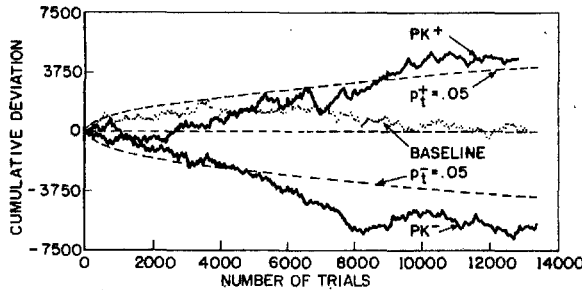

Fig. 17. REG cumulative deviations of PK<sup>+</sup> and PK<sup>-</sup> 2000-sample data.

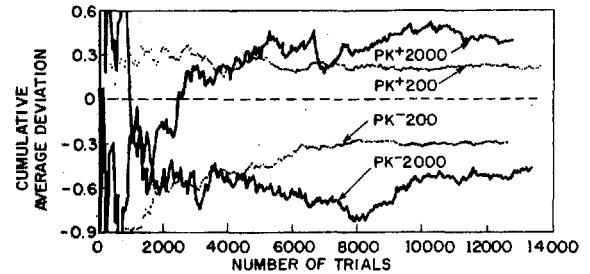

Fig. 18. REG cumulative average deviations of PK<sup>+</sup> and PK<sup>-</sup> 2000-sample data compared to 200-sample data.

inversion accomplished in the 200-bit trials. However, the new values are larger on a per-trial basis by a factor of about 1.7, which is not negligible in this context. Again, much more data of this sort will be required to come to grips with this class of correlation.

In addition to continuing study of this sample-size parameter, our next generation of experiments employs a number of other operators to explore the variation of yield with operator type and technique, and a number of alternate noise sources, including pseudo-random sources, in an attempt to localize the effect somewhat and thereby to narrow the range of future experiments and models.

The results outlined above are by no means the only consequential REG data available for contemplation. Of particular interest are a variety of experiments reported by Schmidt, some employing pseudo-random as well as physically random sources, and others using taped source outputs recorded well in advance of their presentation to the operator [87]-[90]. In another approach, May has recently reported an REG study using electronic gear specifically designed to preclude very subtle artifacts that might confound the effects of interest, and includes in his paper a thorough search of the modern REG literature [91].

In addition, considerable research in the parapsychological community has been performed using REG devices as drivers for various forced-choice video games employed in both the PK and clairvoyance modes [151]. Many of these claim significant yields, but rarely are the data-bases sufficiently large to present quantitative trends, or to allow much parametric correlation.

Regardless of their particular implementation, any potential vulnerability of random electronic noise sources to incidental or intentional distortion by the means under study here would seem to be of some interest to a number of engineering communities, given the proliferate application of such devices in various functional and computational capacities.

#### REMOTE PERCEPTION

As a second example of contemporary psychic research that has displayed some substantial yield and interlaboratory repli-

cability, we select a topic which has come to be called "remote perception" or "remote viewing." The basic concept of this process is far from new; in the early 16th century, Paracelsus stated it unequivocally:

Man also possesses a power by which he may see his friends and the circumstances by which they are surrounded, although such persons may be a thousand miles away from him at that time [8].

In its modern form, the experimental protocol requires a "percipient" to describe, by free-response oral or written narrative or drawing, a remote, unknown target location at which is stationed an "agent," with whom there is no normal sensory mode of communication during the course of the experiment. The targets are usually selected by some prescribed random process from a previously prepared pool of targets, which is unknown to any of the active participants. The quality of the perception is assessed by various impressionistic or analytical judging methods described below.

Historically, this experiment has evolved from several generations of free-response clairvoyance and telepathy experiments, which were found to have certain advantages over the more traditional "forced-choice" ESP tasks, such as the Xener card identifications of the early Rhine laboratory [34]-[37], in displaying less tendency for percipient stagnation and "decline-effects" over extended testing, and in maintaining some of the spontaneity of anecdotal clairvoyance experiences. One of the earliest detailed reports of such free-response studies appears as a book by Upton Sinclair entitled *Mental Radio*, which features an equivocal foreword by Albert Einstein [152]. More modern work of this class was performed at the Maimonides Medical Center by Ullman and Krippner in the 1960's, and reported in their book *Dream Telepathy* [64]. From this work emerged the so-called "ganzfeld" or sensory inhibition perception studies of Honorton and many others which propounded the desirability of emotionally stimulating tasks to which the subjects could relate in a personal and spontaneous fashion [66], [67].

The contemporary version of the remote perception protocol was introduced in a sequence of publications by Targ and Puthoff [94], [153]-[156], which prompted a substantial number of attempted replications [157]-[174], and considerable



Fig. 19. Remote perception target: Picnic area, Feathered Pipe Ranch near Helena, MT; 12:00 N MDT, Sept. 5, 1978.

Percipient transcript: Princeton, NJ; 8:30 A EDT, Sept. 5, 1978:

"Outdoors...open landscape—large areas of trees—pines? interspersed with open fields. Single road. High overcast, cool, breezy. (Agent) in dark jacket talking to someone near road—possibly turnout area or picnic area. Assembly of stones—possibly pylon or marker or wall. Large sign somewhere."

critical comment. The most extensive of the replications, conducted by Dunne and Bisaha in the Chicago area over the period 1976 to 1979, comprised 40 formal trials to which were applied 157 independent transcript judgments, 84 of which assigned first-place rank to the proper targets [161], [162].

The type of data which can be acquired in such studies is illustrated in the sequence of Figs. 19-22. In each case is shown a photograph of a particular target, selected by some random process, which was visited by an agent on the date and time indicated. Below each figure is a portion of the corresponding percipient transcript, with the time and location of the perception effort also noted. The examples shown are drawn from a variety of experimental series conducted under somewhat different protocols, but serve to display some of the characteristics which commonly appear in the more successful efforts:

- 1) The overall ambience of the scene is accurately perceived.
- 2) Certain details are accurately identified; others are misconstrued or totally ignored.
- 3) A feature which is impressive to the agent is not necessarily so to the percipient, and vice versa.
- 4) The composition of the scene may be distorted by errors in scale, relative positions of key objects, or total right-left inversions.
- 5) The aesthetic aspects, such as colors, general shapes, degree of activity, noise level, climate, and other ambient features tend to be more accurately perceived than more analytical details such as number, size, or relative positions.
- 6) The perception is not necessarily centered on the defined target, and may even provide accurate information on adjacent areas external to the target, unnoticed by the agent.
- 7) The fidelity of the perception seems to be independent of the remoteness of the target, up to distances of several thousand miles.
- 8) The time of the perception effort need not coincide with the time the agent is at the target. Perceptions obtained several hours, or even days, prior to the agent's visit to the target, or even prior to selection of the target, display at least as high a yield as those performed in real time.

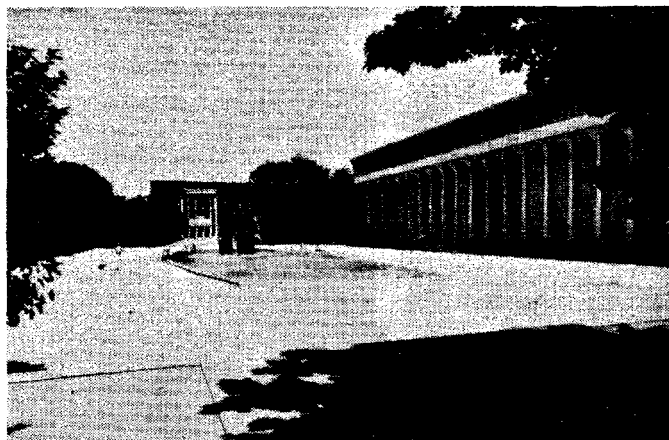

Fig. 20. Remote perception target: Woodrow Wilson School, Princeton, NJ; 2:15 P EDT, Aug. 28, 1980.

Percipient transcript: Princeton, NJ; 12:15 P EDT, Aug. 28, 1980:

"Some kind of courtyard, enclosed by buildings on two sides. Paths or walks around periphery, a statue or monument of some kind in the middle surrounded by grass. Could be a fountain; I have the feeling of water. Trees or tall hedges on one side. Fairly quiet, but some people walking around. Not sure of sound, the idea of a fountain suggests sound of water but I'm not sure I really hear it or not."

The philosophical and practical implications of items 7 and 8 are clearly substantial. If the data are valid, the most parsimonious explications would require access of the percipient's consciousness to other portions of the space-time grid than that in which it is currently immersed, or that it can reach by normal processes of communication or memory. These same items also seriously delimit the potential physical mechanisms for such access.

Rigorous evaluation of the data from experiments such as these is confounded by the psychological components of the process, by the impressionistic nature of the information involved, and by the inevitable subjective biases of all those participating in the experiment. Doubtless the earliest and most primitive assessments were informal *a posteriori* exchanges of impressions about the target between agent and percipient which, although possibly informative and stimulating to them, lacked any quantitative basis and held little scientific credibility. In a somewhat less vulnerable strategy invoked more recently, the percipient, after completing his transcript, visited several possible targets drawn from the pool and attempted to identify the one he perceived, or to rank-order each of them in terms of conformity to his earlier perception. Statistical arguments could then be applied to these ranks to estimate the likelihood that information about the target had been acquired by means other than chance [175]-[177].

In an attempt to separate the possible ESP functioning of the percipient during the visitation and ranking process from his original perception effort, the protocol subsequently evolved to invoke independent judges who were provided copies of the various transcripts and taken to the target sites to perform their preferential rankings. Even in this form, the technique has been criticized for possible sensory cuing of the judges [178] and has tended in turn to be replaced by a protocol wherein the judges perform their ranking on the basis of photographs of the targets, usually taken by the agent at the time of the trial. In one such version, the judges, who have not been involved in any earlier portion of the experiment, are asked to compare a single percipient transcript with agent-generated descriptions and photographs of a number of alternative targets,



Fig. 21. Remote perception target: Rockefeller Chapel, Chicago, IL; 2:15 P CDT, June 10, 1977.

Percipient transcript: Mundelein College, Chicago, IL; 1:00 P CDT, June 10, 1977:

"I'm seeing a heavy wooden door with a black bolt on it rounded at the top in a dome fashion. I have a feeling of opening the doors and looking in and it's dark inside. My feeling at the moment is that it's a building like a church. And I can see the pews. There is some light but I feel basically a kind of darkness in there and a quietness. I'm seeing little turrets, very elaborate-looking little turrets, a whole series of them like across the entire top of the building and there's a straight line and then up to a triangle. I have a definite image of an angel-type of statue, marble, flowing robes. I see the door again and I see some stairs. I think it's very high. I'm getting some stained-glass windows that are arch shape and they would look to be dark blue. Whatever the architecture of it the ornamentation on the building is quite elaborate and it looks like there's a section on the top with the turrets and then below that there are some other kinds of designs but more linear designs.

"I again have a vision of the doors and then maybe a ledged area or an area of the building that protrudes with some kind of a design and there maybe even be a couple of those before you get to the top part which is either triangular or rounded. There is filigree work, little filigree turrets or something. And within the building there is a sort of a continuation of arches, but possibly they meet columns or something like that. I think the decoration is where walls join or separations, it looks like it's arched."

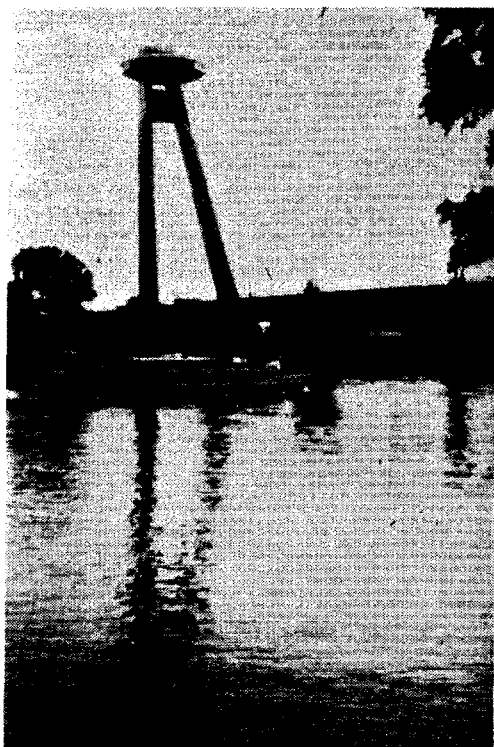

Fig. 22. Remote perception target: Danube River, Bratislava, Czechoslovakia; 3:00 P European Standard Time, Aug. 24, 1976.

Percipient transcript: Minoqua, WI; 8:30 A CDT, Aug. 23, 1976:

"I have the feeling that the agent is somewhere near water. I seem to have the sensation of a very large expanse of water. There might be boats. Several vertical lines, sort of like poles. They're narrow, not heavy. Maybe lamp posts or flag poles. Some kind of circular shape. It's round on its side, like a disc, it's like a round thing flat on the ground, but it seems to have height as well. Maybe with poles. Could possibly come to a point on top. Seeing vertical lines again. Seems to be a strong impression, these vertical lines. Predominant colors seem to be blue and green. Water again. Some very quick impression of a fence, a low fence. The steps seem to go up to some kind of fence. It's a dark fence and it's along like a walk sort of at the top of the steps. The steps sort of lead up to like a path or walkway. Like a boardwalk. And there's a fence along it. There's people walking along it, and there's vertical lines along that walkway."

including the proper target, and to rate or rank-order them by some prescribed criteria. Again, statistical assessment of the significance of the rankings follows.

The bulk of the remote perception data reported in the literature has been evaluated by some form of these independent judging processes, and displays sufficiently high yield to encourage further refinement of the protocol and analysis before attempting categorical judgment on the validity and viability of the phenomena. Beyond minor tightening of the target selection, agent maneuver, and perception acquisition and recording phases of the experiment, the major potential improvements would still seem to pertain to the judging process, which remains potentially vulnerable to subtle cues in the transcripts, to vagaries in the judges' capability, to their subjective biases toward the individual experiments and to the topic as a whole, and to possible psychic input of their own [161], [162].

In an effort to improve the judging process further, our laboratory has explored the applications of various information theoretic methods to the quantification of the data, and an analytic technique has been devised which is based on a limited binary alphabet of target/perception descriptors [179]. While less sensitive to the Gestalt impressionism and symbolic represen-

tations which a human judge might capture, this method does provide a rudimentary framework for evaluation of signal-to-noise ratio in the information transfer, and an assessment standardization less dependent on subjective interpretation. In essence, the strategy is to replace impressionistic assessment of the quality of a perception by the identification of specified elements of information therein, after which a mechanical scoring and ranking procedure takes over. In the hope of conveying a bit more substantive flavor of the data acquired in remote perception experiments and the processing thereof, permit us to describe this analysis in a little detail.

The heart of the method is the establishment of a code, or alphabet, of simple descriptive queries which may be addressed to all targets and all perceptions, responses to which serve to distinguish them and to permit quantification of the information acquired in the perception process. In one version, these "descriptors," thirty in number, are posed in binary form and range over a spectrum from quite factual discriminations, e.g., whether the scene is indoors or outdoors, whether trees are present, or whether there are automobiles, to much more impressionistic aspects, such as whether the ambience is noisy or quiet, confined or expansive, hectic or tranquil. The particular ensemble of descriptors has evolved in part through personal experience and intuition, and in part through trial-and-error application to various pilot data. The goal has been a balanced alphabet whose elements are a) relatively unambiguous; b) commonly perceived by a broad selection of percipients; c) individually instructive in defining the scene; d) complementary to one another; and e) sufficient in number to permit reasonable synthesis of the scene, but not so numerous to burden the data collection or computation excessively.

Given this descriptor alphabet, each target in the pool is then represented in terms of 30 binary bits, corresponding to the appropriate YES/NO responses to the queries. This encoding is normally performed by the agent at the time of target visitation, although reference may be made to the target selector's judgment or to photographs of the target for verification. Each perception is similarly rendered into a corresponding sequence of binary digits, but only after the percipient has been allowed to form a free-response impression of the target. Various scoring recipes are then invoked for quantitative comparison of the perceptions with the targets, using for computation the UNIX operating system of a PDP 11/45 or VAX 750.

The simplest recipe merely counts the number of correct responses to the 30 descriptors, i.e., the positive correlations between the target and descriptor matrices. This does not normally provide a particularly accurate index of the quality of the individual perceptions, since the *a priori* probabilities of the various descriptors are widely different. For example, a given pool may have more outdoor than indoor targets, and hence a correct identification of an indoor context should be given higher credit than identification of an outdoor context. To facilitate such weighting, a step is included in the computational program to provide the *a priori* probabilities of all descriptors in the prevailing target pool, on the basis of which more elaborate scoring recipes may be invoked.

Since the various targets have substantially different characteristics and hence different capacities for achieved scores, a variety of normalization procedures also have been developed, using as denominators the total number of descriptors, the perfect score, i.e., the score that would be achieved for a given target if all descriptors were identified correctly, and various "chance" scores for the target, defined by some random or

TABLE III  
 PRECOGNITIVE REMOTE PERCEPTION 24 X 24 "CHICAGO" SERIES  
 PROPER TARGET RANKS

Perception No.	Scoring Method <sup>a</sup>					Avg.	Avg./24	Human Judges Mean Rank <sup>b</sup>
	A	B	C	D	E			
1	3/4	7	7	9	2	5.9	0.25	2.7/8 = 0.34
2	1/2	2	4	1	1	1.9	0.08	1.0/8 = 0.13
3	1	1	1	1	1	1.0	0.04	1.5/8 = 0.19
4	2/8	7/2	2/2	4/2	2/2	4.5	0.19	2.7/8 = 0.34
5	7/3	9	11	4	8	8.0	0.33	1.7/8 = 0.21
6	9/5	12/2	7/2	16/2	7/2	11.0	0.46	3.5/8 = 0.44
7	13/2	11	14	10	13	12.3	0.51	2.3/8 = 0.29
8	20/3	22	20	14	19	19.2	0.80	1.8/8 = 0.23
9	4/2	4	8	1	5	4.5	0.19	2.6/7 = 0.37
10	10/7	13	13	9	5	10.6	0.44	1.4/7 = 0.20
11	9/4	9	11	6	12	9.7	0.40	3.6/7 = 0.51
12	1/3	2	2	2	5	2.6	0.11	1.8/7 = 0.26
13	1/3	1	3	1	3	2.0	0.08	2.2/7 = 0.31
14	1	2	2	1	1	1.4	0.06	1.4/7 = 0.20
15	1/2	2	2	1	1	1.5	0.06	1.0/7 = 0.14
16	2	2	2	1	2	1.8	0.08	1.0/10 = 0.10
17	1/4	9	1	9	1	4.5	0.19	1.0/5 = 0.20
18	2/2	10	5	1	2	4.1	0.17	1.0/5 = 0.20
19	14/3	14	14	19	17	15.8	0.66	unjudged
20	7/6	11	11	8	10	9.9	0.41	5.0/6 = 0.83
21	1/2	2	3	4	1	2.3	0.10	2.0/6 = 0.33
22	5/6	7	12	2	7	7.1	0.30	3.0/6 = 0.50
23	16/4	23	11	15	9	15.1	0.63	3.0/6 = 0.50
24	3	3	4	3	4	3.4	0.14	2.0/6 = 0.33
Mean	6.73	7.75	7.13	5.96	5.79	6.67	0.28	0.31

<sup>a</sup>Computed rank/number of ties for that rank.

<sup>b</sup>Assigned rank/number of possible ranks.

arbitrary process of descriptor response. A "selective" scoring/normalization process has also been applied which effectively allows the percipient to reject any descriptor on which he feels unqualified to comment, and thence to be scored only on the reduced descriptor set.

The statistical significances of these various normalized perception scores are assessed by a collective ranking process reminiscent of the traditional human judging techniques, but having the advantages that the ranking proceeds on a much more standardized and analytical basis, and that many more alternative targets can be ranked by the machine than by a human judge. Specifically, the program scores each transcript not only against its proper target, but against every other target in the pool, and then ranks these targets in order of descending score and specifies the rank of the match with the proper target. This process is repeated for every scoring method, and the results displayed in corresponding matrix arrays.

Table III displays typical results of these analytical ranking procedures as applied to a group of 24 perceptions of 24 targets in the Chicago area. Tabulated are the ranks of the proper targets compared with all other targets for each of the perception efforts, as computed by five of the scoring methods we have found to be most instructive, namely, A) number of correct descriptors/total number of descriptors; B) weighted full descriptor score/perfect score; C) weighted full descriptor score/number of descriptors; D) weighted selective descriptor score/perfect score; and E) weighted selective descriptor score/chance score. Also included in the table are the mean ranks assigned by independent human judges subjectively comparing these perceptions with a much smaller number of alternative targets. Although the bases of comparison are quite different, it

appears that in the majority of these cases the analytical and impressionistic evaluations concur at least roughly in their estimate of the quality of the perceptions, particularly for those which consistently obtain low rank assignments. If the analytical computation is carried through using as target pool only those alternative targets available to the human judges, the agreement in mean ranks is found to be somewhat closer, perhaps fortuitously so, given the categorically different bases of assessment implicit in the two methods.

To this analytically scored and ranked data it is possible to apply a variety of statistical assessments of widely ranging sophistication and complexity. Consistent with the rather broad mesh of the descriptor code and the elementary scoring recipes invoked in this version of the concept, we confine ourselves to correspondingly simple statistical measures which provide at least semi-quantitative indication of the yield beyond chance. Specifically, we address only the distribution of *proper* target ranks achieved in the series of perceptions, such as summarized in columns 2-6 of Table III. Using the common z-score method for a discrete distribution, the probability of achieving the mean rank of any of these columns by chance may be directly computed. Table IV displays the results of such calculation for the same 24 X 24 "Chicago" series. Note that, whereas all of the methods suggest significant departures of the computed mean ranks from chance, there is relatively little disparity among them, indicating that the specific method of scoring and normalization is not a sensitive element in the overall evaluation of the perception series.

The departure of the shape of the proper target rank distribution from chance is also displayed in Table IV in terms of the number of perceptions achieving first-place ranks, the number

TABLE IV  
 PRECOGNITIVE REMOTE PERCEPTION 24 X 24 "CHICAGO" SERIES  
 SCORE SUMMARY

Method <sup>a</sup>	Mean Rank	No. 1st (2nd) Ranks	No. Ranks Below Mean	z	P <sub>z</sub>	χ <sup>2</sup> (4)	P <sub>χ</sub>
Chance expectation	12.5	1.0 (1.0)	12				
A	6.73	4.4 (4.0)	19	-4.08	2 × 10 <sup>-5</sup>	18.5	<0.005
B	7.75	2.0 (6.0)	20	-3.36	4 × 10 <sup>-4</sup>	11.8	<0.01
C	7.13	2.0 (4.5)	20	-3.80	7 × 10 <sup>-5</sup>	19.6	<0.001
D	5.96	8.0 (2.0)	20	-4.63	2 × 10 <sup>-6</sup>	24.0	<0.001
E	5.79	6.0 (3.5)	21	-4.75	1 × 10 <sup>-6</sup>	27.6	<0.001

- <sup>a</sup>As described in text:  
 A) Number of correct descriptors/total number of descriptors.  
 B) Weighted full descriptor score/perfect score.  
 C) Weighted full descriptor score/number of descriptors.  
 D) Weighted selective descriptor score/perfect score.  
 E) Weighted selective descriptor score/chance score.

TABLE V  
 PRECOGNITIVE REMOTE PERCEPTION 6 X 24 "OCEAN" SERIES  
 SCORE SUMMARY

Method <sup>a</sup>	Mean Rank	No. 1st (2nd) Ranks	No. Ranks Below Mean	z	P <sub>z</sub>
Chance expectation	12.5	0.25 (0.25)	3		
A	4.5	1.0 (1.1)	6	-2.83	0.002
B	4.2	2.0 (0.0)	6	-2.95	0.002
C	5.0	1.0 (1.0)	6	-2.65	0.004
D	5.2	1.0 (0.5)	6	-2.59	0.005
E	5.3	1.0 (1.0)	6	-2.54	0.006

- <sup>a</sup>As described in text:  
 A) Number of correct descriptors/total number of descriptors.  
 B) Weighted full descriptor score/perfect score.  
 C) Weighted full descriptor score/number of descriptors.  
 D) Weighted selective descriptor score/perfect score.  
 E) Weighted selective descriptor score/chance score.

ranked better than the chance mean, and a simple χ<sup>2</sup> test with its associated probability.

The method is not restricted to square arrays, i.e., to equal numbers of targets and perceptions in one-to-one correspondence. Table V displays the results of a recent "Ocean" series in which six perceptions were ranked against 24 targets in the pool from which the six actual targets were drawn. (The percipient for this series was at the time sailing alone across the North Atlantic Ocean.)

Because of its particularly severe protocol, we also include as illustration the results of a "European" series judged by this method. In this series, the agent was traveling in eastern Europe, and on five successive days, at 3:00 P.M. local time, utilized whatever location he happened to occupy as the target. The perceptions of these targets were recorded by a single percipient in northern Wisconsin at approximately 8:30 A.M. local time of the preceding day, i.e., each perception was roughly 24 h precognitive. (Fig. 22 depicts a target and perception from this series.) Table VI displays the analytically judged results of this series, and compares them with the results of previous human judging. Although the data base is small, the consistency of yield is striking.

To obviate the possibility that this method of analysis may somehow process even random inputs to apparently significant scores, artificial target data matrices and artificial perception

data matrices have been constructed from the output of an REG, and the computational schemes applied to various combinations of these with each other and with true data. The pattern of results conforms to chance expectations. An alternative form of control is provided by application of the method to discernibly unsuccessful test series, which yields appropriately insignificant results.

The project outlined in the last few paragraphs is described in greater detail, with many other experimental examples, both successful and unsuccessful, in reference [179]. We have since developed the capability of employing ternary rather than binary responses to the descriptors, in order to convey more shaded information about the aspects queried. A given feature may thereby be specified as a) present and dominant; b) present but secondary; or c) absent. Or alternatively, the feature may be described as a) definitely present; b) ambiguous or unspecified; or c) definitely absent. While these approaches clearly provide more specific target and perception data, the scoring thereof becomes more complex, especially in the definition of certain of the normalization denominators.

We have also been exploring a modification of this analytical judging procedure which would bypass the ranking steps altogether and move directly to compute individual statistical scores for each transcript. The key to this variation is the definition and utilization of a generalized target pool composed of over

TABLE VI  
 PRECOGNITIVE REMOTE PERCEPTION 5 X 5 "EUROPEAN" SERIES  
 SCORE SUMMARY

Method <sup>a</sup>	Mean Rank	No. 1st (2nd) Ranks	No. Ranks Below Mean	z	P <sub>z</sub>
Chance expectation	3.0	1.0 (1.0)	3		
A	1.2	4.3 (0.3)	5	-2.85	0.002
B	1.4	4.0 (0.0)	5	-2.53	0.006
C	1.4	3.0 (2.0)	5	-2.53	0.005
D	1.8	4.0 (0.0)	4	-1.90	0.029
E	1.6	3.0 (1.0)	5	-2.21	0.013
Seven human judges (avg.)	1.9	2.1 (1.6)	4.6		

<sup>a</sup>As described in text:  
 A) Number of correct descriptors/total number of descriptors.  
 B) Weighted full descriptor score/perfect score.  
 C) Weighted full descriptor score/number of descriptors.  
 D) Weighted selective descriptor score/perfect score.  
 E) Weighted selective descriptor score/chance score.

200 targets, local, national, and international, assembled for a broad range of earlier and ongoing experimental series, from which correspondingly generalized *a priori* descriptor probabilities may be calculated. Evaluation of the transcript scores on the basis of these generalized probabilities, rather than those calculated for the specific series target pools, has been found to alter only slightly the relative ranks of the perceptions determined by any of the five methods used above and provides the desired common basis for evaluating the individual statistical significance of those scores.

To pursue this, the program next assembles a set of empirical chance distribution functions, one for each scoring method, by concatenating all mismatched perception scores assigned by that method, i.e., all off-diagonal elements of that perception-target matrix. With reference to Gaussian fits to these empirical chance distributions, the proper perception-target scores can then be assigned z-values and corresponding probabilities against "chance." As one example of this approach, Fig. 23 shows the empirical distribution of scores compounded from some 1400 mismatched targets and transcripts by method E, on which are superimposed the scores achieved by the 24 proper target perceptions of the "Chicago" series. The corresponding z-values and probabilities against chance are listed in Table VII.

These individual significance values can subsequently be compounded into an overall significance level for the entire series by various standard procedures [180]. The latter result should agree with that derived from the original ranking method, to the order of approximation implicit in each form of this analysis. In this case, the series value is about 10<sup>-8</sup>, compared to 10<sup>-6</sup> for the ranking method.

The specific results shown in Tables III-VII represent some of the most successful data we have acquired; many less successful examples could also be displayed. To summarize our total experience with over two hundred remote perception efforts, all performed with volunteer percipients claiming no special abilities, we might note that the data tend to fall into one of four categories, in roughly comparable quantity:

- 1) the target is accurately represented in detail and composition;
- 2) particular features of the target are accurately perceived, but the context is incorrect;
- 3) the ambience of the target is perceived, but the details are inaccurate;

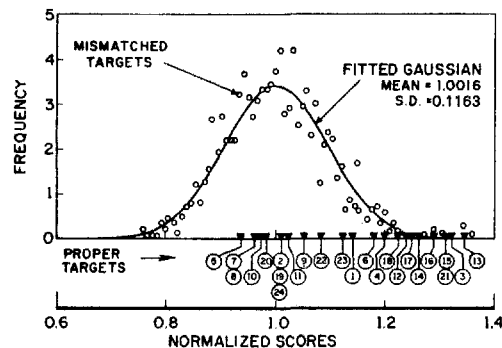

Fig. 23. Remote perception empirical chance distribution (method E).

4) the perception seems unrelated to the target in context or detail.

Survey of the pertinent literature indicates a comparable pattern of yield across the experience of others involved in similar experiments.

To date there has been little progress in correlating the degree of success of such efforts with the prevailing experimental conditions or with the personality traits or attitudes of the participants. A certain body of lore has compounded from the testimony of the more successful percipients, such as the desirability of a personal rapport between the agent and percipient, the value of a lighthearted attitude, the importance of excluding any associative or constructive logic, etc., but much of this is still too vague and inconsistent to provide any basis for experimental refinement or theoretical modeling. At present, the only fair statement would be that empirical evidence for this class of phenomena continues to accumulate, but with frustrating irregularity and little basic comprehension. Notwithstanding, the present and potential applications of the process in a variety of arenas, combined with the relatively simple and inexpensive nature of the experiment, keep this type of study active.

THEORETICAL CONCEPTS

No remotely satisfactory physical theory of psychic phenomena yet exists. Indeed, next to the evasiveness of the effects under controlled experimentation, the second greatest frustra-



TABLE VII  
 PRECOGNITIVE REMOTE PERCEPTION INDIVIDUAL STATISTICAL SCORES  
 (METHOD E) 24 X 24 "CHICAGO" SERIES

Perception No.	z-score	$P_z$
1	1.210	0.113
2	0.089	0.465
3	2.737	0.003
4	1.700	0.045
5	-0.553	0.709
6	1.533	0.063
7	-0.315	0.623
8	-0.315	0.623
9	0.451	0.326
10	-0.197	0.578
11	0.191	0.424
12	2.037	0.021
13	2.948	0.002
14	2.244	0.012
15	2.661	0.004
16	2.478	0.007
17	2.180	0.017
18	1.904	0.028
19	0.083	0.467
20	-0.152	0.560
21	2.679	0.004
22	0.701	0.241
23	1.057	0.145
24	0.113	0.455

tion in the study of psychic processes has been the absence of viable theoretical models with which to begin the traditional dialogue between theory and experiment on which all scientific progress eventually depends. This may, of course, be indicative of an illegitimacy of the phenomena themselves, or at least of an evanescence that fundamentally precludes any analytical representation. On the other hand, it may be an indication that modern physical theory, elaborate and sophisticated as it is, has not yet evolved to a stage where it can properly acknowledge and deal with the role of consciousness in the physical world [181], and that this should be one of its new frontiers. Before pouncing toward either extreme, it may be worthwhile to play through some of the more canonical attempts that have been made to deal with this domain, both from a formalistic and philosophical point of view.

Efforts toward theoretical explication of psychic phenomena over the past century have proceeded from various levels of presumption as to the fundamentality of the effects observed. Some have insisted that the effects are totally illusory, i.e., artifacts of poor experimentation or data processing, or that they are the chance results of random processes. Others have assigned the effects to known physical and physiological mechanisms associated with, but not deliberately precipitated by the participants, e.g., electromagnetic radiation from brain circuitry or intercardial potentials, or heat transfer, vibration, or aerochemical changes in the experimental environment caused by human presence or exertion. More ambitious efforts have contended that no such conservative models can suffice, and that it will be necessary to identify new forms of energy or information transfer to retain the established physical formalisms, or possibly even necessary to expand the physical laws themselves, as was required in the generalization from classical mechanics to quantum mechanics or to special and general relativity, with the present forms becoming subsumed under more comprehensive statements. Still others have concluded that the scientific paradigm in general is inadequate and that basic revision

in the representation of the process of conscious observation of physical events will be required.

Beyond the uncertainty as to the fundamentality of the model required, these modeling efforts have labored under the confusion of whether the purported phenomena are most basically psychological, physiological, physical, or some inextricable combination thereof, and hence which class of concepts should dominate the model and which should be secondary. Virtually all permutations have been explored to some degree, under labels of "psycho-physiological," "biophysical," "psycho-physical," etc., but none of these can claim more than suggestive analogies or philosophical stimulation. This author is unqualified to assess any models based in the psychological or physiological domains, other than to note that those most frequently discussed tend to acknowledge the role of random processes, information ordering, and statistical, rather than directly causal mechanisms [182]-[187], all of which have their counterparts in several of the more physically oriented modes which have been proposed. Confining ourselves to such physical theories, the history of credible analytic effort is conveniently short and, in my view, more instructive in its philosophical than in its functional characteristics.

#### *Electromagnetic and Geophysical Models*

For perhaps naive reasons, the earliest physical models tended to presume wavelike propagation of psychic effects, usually in the electromagnetic modes [188]. Doubtless the concurrent emergence of radio technology with its revolutionary wireless capabilities influenced the concepts and nomenclature of these versions, and frequent reference to psychic "transmitters," "receivers," "antennas," "tuning," and "static" are found in them. Upton Sinclair's book, *Mental Radio*, mentioned earlier, is one example of such an analogy [152].

More modern models of this genre, appearing predominantly in the Russian literature [43], [50], [100], [189], [190], have focused on very low frequency bands, of the order of 10 Hz,

characteristic of various physiological frequencies, especially the brain wave spectra. Some variations of these have invoked modulation of the earth's magnetic field or of the electrostatic fields of the atmosphere. Wave models involving other than electromagnetic environmental media have also been proposed, such as infrasonic atmospheric waves, geoseismic waves, and barometric fluctuations, possibly stimulated by contemporary attention to the inexplicable homing capabilities of birds, fish, and animals, and the hive or swarm behavior of certain insects [101], [102], [132].

As suggested by the pre-occupation with screen-rooms in the early days of the electromagnetic concept, and by more recent long-distance remote perception experiments, some of the obvious validation/disqualification tests examining attenuation, diffraction, interference, and polarization effects have indeed been attempted, but the very large dimensions involved for these wavelengths leave the studies less than conclusive. Some contemporary workers retain support for this category of model, claiming that the necessary electromagnetic signal levels required for influence on the brain circuitry are so small that no coarse-grained tests can properly discriminate against them. More problematic, in my own view, are the absence of any demonstrated velocity of propagation of psychic effects and the large body of precognition evidence which, if accepted, cannot be accommodated by any reasonable advanced wave characteristics.

However, setting aside for the moment the quantitative functional difficulties with the electromagnetic approach to psychic phenomena, certain broader philosophical analogies in the conceptual and experimental aspects of the two topics may be worth noting. In electromagnetism, beyond the bald empiricism of the definition of the fields themselves as representations of "action-at-a-distance," there are many features which to a naive or primitive observer would, and indeed historically did, appear as "paranormal," or at least anomalous: the noncolinear aspects of Ampere's and Biot-Savart's laws and of the Faraday effect; induction effects and switching transients; the Maxwell displacement current; the propagation of waves in a vacuum, with a specified finite velocity—each of these in some sense digressed from contemporary "normal" experience, was conceptually difficult in its time, and required certain leaps of empiricism to get on with the formalism.

To the extent that we just now hold a similarly naive and primitive view of psychic phenomena, it may be necessary to tolerate similarly empirical representations until a more comprehensive model can knit itself into a more fundamental representation. For this purpose, there may be some merit in looking to just such electromagnetic effects for analogies. As one example, the pervasive "decline effect" in psychic experimentation, wherein the performance on psychic tasks is widely reported to be highest immediately after initiation, to decrease over protracted testing periods, and then to improve again just before termination, is somewhat reminiscent of the induced signatures of certain electromagnetic processes. The decline effect has been commonly ascribed to a psychological boredom or reduction in the emotional intensity of the operator performing the task; just possibly it may be a more fundamental characteristic of the phenomenological domain.

In a similar vein, many psychic effects are reported to be intrinsically transient, e.g., the "fleeting impression"; the "sudden vision"; the "unexpected effect." One of the favored techniques of some remote perception percipients is to "sweep through" their image of the target repeatedly until it is clarified. Many

PK effects are reported to be achieved just at the first effort or immediately after the effort is terminated. Such "beginner's luck" evidence might be construed to indicate that psychic processes are invalidated by prolonged and careful examination; alternatively, it may be a hint that they are inherently "inductive," in the electromagnetic sense, i.e., that they are intrinsically unsteady phenomena wherein the time derivatives influence the magnitudes of the effects.

Yet another characteristic that psychic effects share with certain electromagnetic processes is their tendency to be indirect, tangential, or peripheral: direct effort on one PK task fails, but a secondary effect is noted on another component or device; central elements of a remote perception target are ignored by the percipient, but minor or peripheral aspects are identified with precision; the pattern of physical disturbance in a poltergeist event is reported to be vortical rather than radial, all of which call to mind cross-product and vector curl effects in the electromagnetic domain.

The point in suggesting such analogies is not to endorse direct physical correspondence between electromagnetic and psychic processes, but rather to speculate whether the human mind may tend to perceive and assess phenomena in the two domains in certain similar fundamental ways.

#### *Entropy and the Random Process*

A second, more recently opened class of psychic model addresses the interaction of consciousness with natural random processes [95], [187], [191]. A common aspect of the established physical formalisms of kinetic theory, thermodynamics, statistical mechanics, and information theory is the role of randomness as the reference plane for information and energy exchange. By whatever representation, the second law of thermodynamics, expressing the tendency of isolated physical systems to drive irreversibly toward configurations of minimum order and information content, stands starkly asymmetric in the time coordinate, thereby raising profound philosophical issues in virtually every domain from biophysics to cosmology.

Some of the most controlled and replicable experiments in PK, such as the REG studies outlined earlier, could be construed to challenge the second law, or at least to suggest modifications of the concept of an isolated physical system. Namely, under the circumstances of those experiments, human consciousness could be postulated to be inserting order, albeit to a small degree, into a random physical process.

This possibility can be extended conceptually to the anomalous acquisition of information in remote perception experiments, to psychic healing, and to animal and plant PK, but to my knowledge, no attempts at formulation have yet specified any details of the ordering capability, e.g., its physical or physiological source, its propagation modes, or its manner of interaction. Pending these, one can again only proceed with high empiricism to attempt to represent the observed correlations in a useful fashion, a strategy which has sustained many other observational fields in their primitive phases. Notwithstanding, this class of psychic model poses a profound question: The long-accepted essence of consciousness is its ability to extract information from its environment; may the reverse also be possible? May consciousness have the ability to insert information into its environment?

One extreme variation of this model escalates the question even one step further, to ask whether it is possibly an indigenous property of extremely elaborate and complex systems that they may embody inherent functional consciousness of

their own—that somehow out of their very complexity, the interlockings of their systems, they derive not only abilities to learn, to reproduce themselves, to adapt to their environment, but also to exert an entropy reversing form of “consciousness” on themselves [192], [193].

*Hyperspace Representations*

A few attempts have been made to represent paranormal effects by re-casting the basic laws of physics in more than the four coordinates of normal human experience and applying the consequent new terms to the representation of paranormal effects [104], [105], [194]. For example, one such approach adds an imaginary component to each of the spatial and temporal coordinates, i.e., invokes complex space and time, somewhat in the spirit of ac circuit theory or exponential wave mechanics [195]. The imaginary components and their “cross-talk” with the traditional real ones thereby permit representation of anomalous effects within the framework of established physical laws. To date, no convincing fundamental definition of these new dimensions has been offered, thereby reducing such models to an heuristic or empirical level. In this sense, the approach bears some similarity to the “hidden variable” aspect of quantum mechanics, mentioned below.

One may speculate that if such models are to address the interaction of consciousness with physical process, the requisite new coordinates or components must relate to, or in some way define or localize, the processes of consciousness. In other words, to the normal “hard” coordinates, whereby events are conventionally specified in the physical world, it may be necessary to add certain “soft” coordinates to specify the conscious processes by which those events are perceived and possibly influenced. Clearly, the coordinate frame in which one chooses to observe and represent any physical process is intimately linked to the perception of that process. Two common examples would be the perceptions of kinematic and dynamic effects in a rotating frame of reference, such as a merry-go-round or an orbiting spacecraft, or the even more bizarre appearances of physical processes in rapidly accelerating frames, à la general relativity.

To compound this interdependence of perception and reference frame by including “consciousness coordinates” in the specification of the latter is an awesome proposition, but an intriguing one. And the consequences need not be restricted to the mechanical behavior of physical systems, but may also influence their perceived substance. The noted British astronomer Sir Arthur Eddington, some fifty years ago, presaged this concept most boldly and heretically [196], [197], [203]:

The whole of those laws of nature... have their origin, not in any special mechanisms of nature, but in the workings of the mind....

All through the physical world runs that unknown content which must surely be the stuff of our consciousness....

Where science has progressed the farthest, the mind has regained from nature that which the mind has put into nature....

We may look forward with undiminished enthusiasm to learning in the coming years what lies in the atomic nucleus—even though we suspect that it is hidden there by ourselves....

The stuff of the world in mind-stuff.

*Transform Models*

Another rather extreme approach proposed recently has come to be referred to as the “holographic” or “transform” model [198]–[200]. Essentially what is suggested here, as I understand it, is that the information of the universe is arrayed, not

in terms of position and time as we have come to perceive it, but rather as frequency and amplitude information, and that the human consciousness essentially performs “Fourier transforms” on this to order that information into the more familiar form. In the sense that the space and time coordinates are thereby downgraded from the fundamental coordinates of experience to useful ordering parameters, one could interpret such models to imply that consciousness may, by this mechanism, access any portion of space and time to acquire information, and then interpret it in some characteristic form.

The physicist David Bohm, in conjunction with the psychologist Karl Pribram, has elaborated such concepts to a considerable degree of generality, proposing a so-called “implicate order” or “enfolded order” of fundamental reality from which the more familiar “explicate order,” i.e., the commonly manifest perceptions are assembled in accordance with the prevailing circumstances of their observation [201], [202].

*Quantum Mechanical Models*

Probably the most exercised category of contemporary model attempts to apply the concepts and formalisms of quantum mechanics to represent some of the paranormal effects presented in the psychic domain. Of all the forms of physical analysis, quantum mechanics invokes the largest array of empirical postulates that are at variance with conventional rationality, and yields in their implementation a corresponding array of results which contradict common impressions of reality. The quantization process itself, which limits measurable properties to discrete values; the representation of particulate systems by wave functions; the role of observation in collapsing the wave functions to a single state vector; the uncertainty principle; the exclusion principle; the indistinguishability principle; and most drastic of all, the commitment to totally probabilistic mechanical behaviors—all, in some sense concede a degree of paradox in human perception of physical processes. The familiar conundrums of “Schrödinger’s Cat,” “Wigner’s Friend,” or the “Einstein–Podolsky–Rosen Paradox,” all suggest that the laws of quantum mechanics are not so much statements of fundamental physical reality, as of our ability to acquire information about that reality. Quantum mechanics, in other words, does not so much describe the state of a physical system as it describes our *knowledge* of the state of that system.

It is somewhat in this spirit that a number of authors have aspired to model psychic process in quantum mechanical terms. Some have attempted to invoke the so-called “hidden” or unused variables of the formalism to involve conscious process more explicitly in the behavior of physical systems [107], [204]–[208]. Others have endeavored to draw analogies between the synaptic processes in the brain and quantum mechanical “tunneling” [209].

Given the primitive state of the phenomenological data base, much of this effort may be prematurely elaborate and complex. Our own approach to quantum mechanical modeling has been far more superficial and generic, attempting only to explore possible analogies between the paradoxical consequences of the formalism, and the paranormal evidence of certain psychic experiments. Again with the indulgence of the reader, we might sketch a bit of this argument, for the purpose of illustrating this class of approach with the example closest to hand.

One conventional interpretation of the application of quantum mechanical formalism to the observable behavior of physical systems is to associate appropriate mathematical operators with a corresponding measurement process. When applied to

the prevailing wave function of the system, these operators call out the observable values of the property in question as eigenvalues of an equation of the form

$$M\psi_i = m_i\psi_i$$

where  $M$  is the measurement operator,  $m_i$  are the observable values of the measured property, and  $\psi_i$  the corresponding eigenstates of the wave function. Our approach is to generalize this representation to include conscious systems as well as conventional physical ones, and to allow the measurement operator concept to include specification of psychological as well as physical properties.

Thus, we denote a particular individual consciousness by a "state function"  $\psi_i$ , and represent a situation to which it is exposed by an operator  $S$ . Application of the situation operator to the consciousness wave function then yields the possible psychological responses,  $s_i$ , as eigenvalues:

$$S\psi_i = s_i\psi_i.$$

We then invoke certain aspects of quantum mechanical interaction theory to develop the capacity for "paranormal" behavior of both physical and conscious systems. For example, in the traditional theory of the covalent chemical bond between two hydrogen atoms, one constructs from the separate atomic functions,  $\psi^a$  and  $\psi^b$ , using arguments of symmetry and indistinguishability, a composite molecular wave function  $\psi^{ab}$ , which yields expectation values for the molecular energy levels substantially different from simple linear superposition of the atomic energy eigenvalues, i.e.,

$$e_i^{ab} = e_i^a + e_i^b + \Delta e_i^{ab}$$

where  $e_i^a$  and  $e_i^b$  are the energy eigenvalues of the atomic systems, and  $\Delta e_i^{ab}$  embodies an "exchange energy" term which is classically inexplicable, but devolves formally from the postulate that the electrons are indistinguishable in the bonded configuration. Stated more bluntly, surrendering information about the identity of the atomic electrons in the molecular configuration leads directly to a significant and observable component of the binding energy, thus posing an equivalence between information and energy far more stark than that implicit in the second law of thermodynamics.

Using similar formalism, we may represent the state function of two interacting individuals, or of an interacting individual and physical system, by a composite state function  $\psi^{ab}$  whose behavior characteristics also differ significantly from those of the separated systems, i.e.,

$$s_i^{ab} = s_i^a + s_i^b + \Delta s_i^{ab} + \Delta s_i^{ba}$$

where  $s_i^a$  denotes the "normal" response of the first individual to the prevailing situation, and  $s_i^b$  that of the second individual or of the physical system, and  $\Delta s_i^{ab}$  and  $\Delta s_i^{ba}$  denote modifications of those behaviors arising because the two systems are strongly interacting during the observed situation.

As a specific example, to apply this approach to remote perception experiments we could denote the percipient by  $\psi^P$ , the agent by  $\psi^a$ , and the experimental protocol by the mathematical operator  $P$ . In the absence of interaction between the percipient and agent, each would have certain "normal" reactions to the experimental situation,  $p_i^P$ ,  $p_i^a$ , derived from the eigenvalue relations:

$$\begin{aligned} P\psi_i^P &= p_i^P\psi_i^P \\ P\psi_i^a &= p_i^a\psi_i^a \end{aligned}$$

i.e., the percipient would perceive nothing about the target that was not accessible to his normal perceptual modes, and the agent would react to the target under no influence from the percipient.

However, if the percipient and agent are strongly enough interacting to require a new "molecular" wave function,  $\psi^{Pa}$ , "paranormal" terms will appear in their response patterns:

$$p_i^{Pa} = p_i^P + p_i^a + \Delta p_i^{Pa} + \Delta p_i^{aP}$$

where in  $\Delta p_i^{Pa}$  we may accommodate the anomalous acquisition of information about the target, and in  $\Delta p_i^{aP}$  the commonly reported experience of the agent of having his attention attracted to specific details he would "normally" have ignored.

Application of this formalism to a PK experiment proceeds in a similar fashion. Here we might represent the experimental operator (person) by  $\psi^o$ , and the experimental device by  $\psi^d$ . Again the experimental protocol is represented by a mathematical operator,  $K$ . In the absence of major interaction, the device behaves "normally":

$$K\psi_i^d = k_i^d\psi_i^d$$

and the operator has the "normal" psychological experiences:

$$K\psi_i^o = k_i^o\psi_i^o.$$

But if the operator and the device are in some state of resonance,  $\psi^{do}$ , each behaves somewhat differently, i.e.,

$$k_i^{do} = k_i^d + k_i^o + \Delta k_i^{do} + \Delta k_i^{od}.$$

The anomalous modification in the behavior of the system  $\Delta k_i^{do}$  is termed PK;  $\Delta k_i^{od}$  accommodates any paranormal psychological reactions of the operator.

Development of further illustrations of this general method here would be inappropriate and would require more detailed specification of the nature of the consciousness wave functions, their functional form, their proper "soft" coordinates, and the interpretation of their quantum numbers. Some of this has been attempted, along with various other applications to the psychic domain, and is available in a reference [210]. The point of exposition here is largely a philosophical one: namely, the "paranormal" effects emerge as a consequence of the comparison of the behavior of an interacting system with that of its separated components.

Quantum mechanics may have quite another analytical precedent to contribute to the representation of psychic phenomenology. Clearly, much of the psychic research data will continue to be acquired and processed in statistical form, using established statistical methods. Yet, all statistical models ultimately trace back to certain fundamental probability rules for the elemental systems involved. For the statistical models to be viable, these probability rules must a) exist; b) be known; and c) be analytically tractable. At present, virtually all processing of psychic research data presumes the applicability of classical statistics, yet the basic probability rules for the elemental processes are, in point of fact, unknown [211], [212].

It may fortuitously be the case that much of psychic process can be adequately treated as marginal deviation from classical chance behavior. In some cases, however, it may be necessary to invoke categorically different statistics, tracing back to fundamentally different probability rules, to deal with the effects. The quantum mechanical precedents of relevance, of course, are

the two systems of quantum statistics, i.e., the Fermi-Dirac and Bose-Einstein systems, which are based upon the phase-space population rules for half-integer and integer spin particles as imposed by the Pauli principle, i.e., the wave function symmetry requirements. For most common physical systems, these quantum statistics conveniently degenerate into the classical form, but for certain special situations, e.g., the specific heats of metals and certain radiation properties, their full application is essential.

By analogy, one could postulate that physical reality, as perceived and influenced by human consciousness, actually plays by more elaborate probability rules than commonly attributed to it, and hence strictly requires a more complex statistical mechanics. Thus, in this view, the processes commonly regarded as "normal" would be those for which the "classical" approximation to this more complex system is adequate; small-scale psychic effects would then comprise those displays of minor deviations of the complex statistics from the "classical" limit; the more drastic phenomena—poltergeists, levitations, metal bending, etc.—would presumably become explicable only in terms of the full statistical formulation.

*Holistic Models*

Yet more extreme in conceptual difficulty is a body of contention that psychic processes are inseparably holistic, and that no model rooted in any sector of established science can adequately represent them [213]. In particular, the suggestion is offered that psychic processes are manifestations of the interdiffusion of the analytical, scientific world with the creative aesthetic world, and thus to represent them effectively it will be necessary to combine the philosophical perspectives and techniques of both domains. To resort to metaphor for illustration once again, one could ponder such analogies from the common physical world as the interface regions between the sea and land, where the diffuse patterns of the ocean wave structure meet the solid promontories and sloping beaches of the coast to produce the crashing breakers and hissing foam of seashore phenomena, or the overrunning of a warm, moist atmosphere by a cold-front of drier, cooler air to initiate the striking electrical and acoustical phenomena of the summer thunderstorm.

By whatever analogy it may be illustrated, theoretical representation of the interpenetration of causal physical mechanics with creative conscious process must be a formidable undertaking, yet not totally without precedent or allied effort. For examples, interest is just now growing in the humanistic psychology community in the analytical study of human creativity [214]-[216], and, on the other side of the interface, a few physicists are beginning to muse openly about the role of aesthetics in subnuclear and cosmological physical behavior [217]-[220]. In yet a different arena, certain futurists are now examining the interplay of aesthetic and functional human needs and values in the evolution of social and political structure [221]. To be sure, none of these has produced much in the way of analytical formalism, but the peculiarity, magnitude, and significance of the interpenetration effects are being acknowledged.

Any summary assessment of the status of physical models of psychic phenomena should properly begin with reiteration of the opening statement: none of the approaches outlined above has yielded anything approaching a functional theoretical basis. Yet, the ensemble of empirical experimental experience seems to suggest that certain of the conceptual and perceptual char-

acteristics underlying those formalisms may be relevant to ultimate representation of such processes. Specifically, they suggest that the following rather general hypotheses may be worthy of more detailed examination:

1) The phenomena may be inherently statistical, rather than directly causal, and we may be observing them "on the margin." That is, the observed phenomena may represent marginal changes from normal behavior on a very grand scale and with fluctuation times which tax human observational capability. It also may be necessary to deal with more complex statistical mechanics, appropriate to more involved basic probability rules, to represent the most drastic effects.

2) Just as human consciousness has the ability to extract information from an external system, e.g., by observing it, that consciousness may also have the ability to project information into it, e.g., by ordering random processes.

3) Quantum mechanics may be more than a system of physical mechanics; it may be a more fundamental representation of human consciousness and perception processes, and the empirical pillars of this formalism, such as the uncertainty principle, the exclusion principle, the indistinguishability principle, and the wave/particle dualities may be as much laws of consciousness as laws of physics.

4) Psychic processes may be inherently holistic, and thus the ultimate model may need to integrate both the scientific and the aesthetic aspects in order to identify the sources of the phenomena. That is, psychic processes may be manifestations of the intersection of the analytical, scientific world with the creative, aesthetic world, and thus, to represent them effectively, it may be necessary to integrate both perspectives without sacrificing the integrity of either.

Clearly, any of these intuitions will have to be developed in far more philosophical and analytical detail before a trenchant theoretical model can emerge, but at this primitive stage it is probably stimulating to consider a few such radical possibilities, along with more prosaic explications. Changes of this magnitude in representation of human perceptual reality inevitably, and properly, would be attended by much philosophical recalcitrance and agony, but the broader personal and collective insights that could derive from legitimate efforts to bridge the analytical/aesthetic interface could be of at least corresponding benefit.

THE NEGATIVE SIDE

Contemporary criticism of psychic research and rejection of the phenomena it purports to demonstrate tend to focus on a number of specific objections, each of which has some degree of validity and merits some thought in any balanced assessment of the topic [118], [178], [222]-[224]. The most commonly cited concerns include:

- 1) demonstrable fraud;
- 2) naivete of technique, including inadequate controls, faulty equipment, sensory cuing of participants, other experimenter biases, selective treatment of data, improper statistical methods, and general experimental and theoretical incompetence;
- 3) little improvement in comprehension over many years of study;
- 4) absence of adequate theoretical models;
- 5) suppression of negative results;
- 6) poor experimental replicability;
- 7) elusiveness of effects under close scrutiny;

- 8) sensitivity of results to participants, attitudes, and laboratory ambience;
- 9) tendency for many results to be only marginally significant compared to chance expectation;
- 10) inconsistency with prevailing "scientific world view;"
- 11) contradictory to personal psychology, philosophy, theology, or "common sense."

Obviously this list runs a gamut from rather technical and procedural objections, through phenomenological inconsistencies, to rather categorical and subjective rejections, and only a few of these issues can be constructively addressed here.

Unfortunately, but undeniably, one or the other of the first two judgments may legitimately be applied to a large body of the propounded results. By its nature, the field is immensely vulnerable to fraudulent exploitation and naive gullibility, and such have indeed occurred to a distressing degree. It is also true that the topic has attracted a disproportionate share of less than fully competent researchers, and that it presents extraordinary pitfalls for even the most disciplined scholars. Yet despite the substantial validity of these claims, and the suspicion they inevitably cast on all other results, it does not seem that they should predicate categorical rejection of the entire field. Rather, the vulnerable cases should be patiently ferreted out using obvious scholarly criteria, and only those efforts surviving such scrutiny used for scientific insight and judgment.

The lack of definitive progress toward comprehension of the phenomena and the absence of viable theoretical models have already been acknowledged in the foregoing text, and although these assessments should perhaps be qualified by the relatively minute integrated investment of resources made in this field in comparison to many of the more favored areas of science, they nonetheless constitute legitimate concerns about the ultimate tractability of the field. It should perhaps also be noted that, despite the prolonged effort, it is only very recently that more sensitive and powerful experimental equipment and data processing techniques have been brought to bear, and equally recently that more sophisticated physical formalisms have been invoked, and that these have had a much briefer opportunity to render the phenomena into comprehensible terms.

The subsequent five objections, 5)-9), are more specific and substantive, and merit examination from two orthogonal points of view. Namely, to what extent do such characteristics indeed invalidate the results, and conversely, to what extent might they illuminate the basic nature of the phenomena? With respect to suppression of unfavorable results, there has undoubtedly been some tendency in this field, as in most others, to advance positive or definitive findings more enthusiastically than negative or equivocal ones. Indeed, this paper has been guilty of the same bias. In an effort to provide concise representation of the style and substance of psychic research and of the nature of the effects it can produce, we have tended to invoke as illustrations some of the more successful and familiar pieces of work without balancing the presentation with comparable examples of the negative or equivocal results that are regularly acquired in these efforts.

To the credit of the psychic research community, it has officially encouraged thorough and objective reporting of negative data, and much of these indeed appear regularly in its established journals [225]-[228], with a number of consequent benefits. First, beyond adding credibility to the body of positive results, such data compound to provide some quantitative index of the

ratio of positive to negative yields in a given class of experiment, thereby contributing to a broader sense of the grand statistics of the phenomena. In addition, documentation of the specific conditions prevailing in unsuccessful experiments may be helpful in excluding irrelevant parameters from further consideration, and in identifying and reducing counterproductive influences. Perhaps most pointedly, however, the body of negative and equivocal data emphasize that psychic phenomena, if real, are highly irregular and sensitive to intangible influences well beyond current scientific control, and, if their study is to be pursued, this caveat must be accepted *ab initio*, at least for the present.

A similar interpretation also applies to the irreplicability complaint, and to the three following it. Without question, the dominant experimental frustration in this field is the inability to replicate on demand previously observed paranormal effects, not only at other laboratories, but even in the original facility, using the original participants, under apparently identical experimental circumstances [172], [173], [229]-[231]. This ubiquitous characteristic has precipitated major philosophical excursions which are well beyond our capacity to review here. Only briefly, four possible categorical interpretations have been advocated:

- a) The phenomena are illusory.
- b) The phenomena are rare and bizarre chance occurrences, beyond any hope of regularization.
- c) The phenomena are precipitated, at least in part, by psychological and/or physiological factors which are presently beyond experimental control, but which if fully comprehended would conform to established scientific paradigm.
- d) The phenomena are inherently statistical, and possibly quantum mechanical, on a macroscopic scale, thus manifesting themselves with finite but fractional probability on any given occasion.

The latter pair of options are not necessarily mutually exclusive, particularly if one takes a rather generous doubly statistical point of view, namely that the human population embodies a range of capability for engendering such effects and that beyond that, any individual may display a variable range of personal capacity, depending on a variety of environmental, physiological, and psychological factors prevailing at the time.

The evasiveness of the phenomena under carefully controlled and observed study may be the most damning criticism of all, or it may also constitute a valid and illuminating phenomenological characteristic. The tendency of a given preliminary or anecdotal effect to disappear or diminish when the experiment is tightened, or when it is displayed to a skeptical jury of observers, obviously casts major doubt on the scientific integrity of the process. Yet it also brings to mind at least two other processes which, while superficially dissimilar, may not be totally irrelevant, namely artistic creativity, and quantum mechanical measurement as limited by the uncertainty principle. In the former, there should be little quarrel that the creative processes of artistic, musical, or literary composition, or of lofty philosophical thought in general, are not usually facilitated by rigid constraints or by the presence of a body of unsympathetic observers. The importance of favorable ambience and mood for such efforts is intuitively and demonstrably clear, and little creative achievement is likely to occur in overly sterile or hostile environments, a truth Richard Wagner vividly conveyed to his own critics by his portrayal of the fate of young Walther at-

tempting his avant-garde "Trial Song" before the assembled Meistersingers. Virtually every creative artist preserves some form of retreat or sanctuary, and even the most rigorous of scientists will concede the role of unstructured mental imagery in enhancing their technical insights.

The analogy of the quantum mechanical measurement process is somewhat more strained, in that it requires generalization of the concept to the macroscopic level of information or energy exchange between two persons or between a person and a physical system. The point will not be developed here, other than to note that if there is any validity to the application of quantum mechanical logic to this class and scale of intellectual/intuitive process, as discussed earlier and in the references, some form of "uncertainty principle" could predicate a limit to the precision with which psychic effects could be observed. More specifically, if the "hard" and "soft" coordinates of representation are canonically conjugate, some form of  $\Delta q \Delta p \sim h$  rule may apply, so that attempts at excessive precision in specification of a psychic effect could dissipate its cause, and vice-versa [210].

The final two reservations regarding inconsistency of the phenomena with established scientific and personal views, while constituting powerful professional and personal discriminators and properly predicating great caution and discipline in venturing into any anomalous field, also cannot be allowed total veto authority if new domains of conceptual experience are ever to be challenged. In responding to a critic of an earlier paper who stood on these points I wrote, perhaps too floridly,

Authoritarianism such as this encourages established knowledge to sit smugly on its duff and categorically reject all new evidence that does not support or fill in its contemporary "world-view compatibility criterion"—whatever that is. Worst of all, it stifles the most precious attribute of human consciousness, the yearning for ever new, ever higher wisdom that has driven the mind and spirit of man to evolve upward, rather than merely to replicate [232].

More persuasive to this issue, however, would be a simple historical count of the number of leaps of scientific insight, from Aristotle to this day, which would have been, and in most cases were, for a time, rejected on the basis of these criteria. Curiously, it has often been those giants of science who with soaring insight and courage of conviction violated such tenets to lead their fields to new plateaus of understanding, who also, in a later day, led the recalcitrance of the establishment against comparably sacrilegious visions of their successors, while still endorsing in general terms the importance of visionary thought. Galileo, early champion of scientific methodology and revolutionary concepts in terrestrial and celestial mechanics against vicious dogmatic opposition, rejected Kepler's elliptical orbits as "occult fantasy"; Thomas Young, whose brilliant interference experiments finally established the wave character of light, contended with Fresnel's theoretical formulations of the same processes; Ernst Mach disputed relativity and atomic theory; Rutherford, who showed the world the nuclear atom, dismissed any practical significance for nuclear energy; Lavoisier and Ostwald disputed atomic theories of chemistry; D'Alembert opposed probability theory; Edison discounted alternating current; Lindberg despaired of Goddard's rocketry; and Albert Einstein retained an enduring uneasiness about quantum theory despite his many contributions to its evolution [233]–[235]. Incidentally, the same Albert Einstein who would invoke the establishment criteria against Upton Sinclair's clairvoyance

data:

...the results of the telepathic experiments carefully and plainly set forth in this book stand surely far beyond those which a nature investigator holds to be thinkable [152]. could in quite another tone testify eloquently to the importance of the aesthetic dimension in creative science:

The most beautiful and most profound emotion we can experience is the sensation of the mystical. It is the sower of all true science. He to whom this emotion is a stranger, who can no longer wonder and stand rapt in awe, is as good as dead. To know that what is impenetrable to us really exists, manifesting itself as the highest wisdom and the most radiant beauty which our dull faculties can comprehend only in their most primitive forms—this knowledge, this feeling is at the center of true religiousness.

The cosmic religious experience is the strongest and noblest mainspring of scientific research [236].

Individually and collectively, these critical challenges to psychic research raise valid concerns which merit deliberate attention and predicate great caution, and can also help to illuminate some of the subtle phenomenological features. However, they can perform these functions well only if they themselves are informed, reasoned, and fair. Regrettably, from my reading of the critical literature, this has not invariably been the case, and instances of naiveté, selective representation of data and protocol, and excessive generalization also appear therein.

The role of the critic in psychic research is a most essential one, perhaps more so than in any field of scholarship yet broached. When the criticism is based in fact and experience and is objective and fair, it can instill healthy discipline in the study of this or any other difficult field and ensure that the fundamental requisites of scientific methodology, e.g., dispassionate rigor, humility in the face of observations, limitation on extrapolation of results, and openness of mind will prevail in the search. But it is equally essential that the process of criticism play by these same rules. If it violates any of them, if it lapses into categorical rejection, guilt by association, or sloppy logic, it can become as suspect as the object of its complaint, and thus fail in its proper role [237].

IMPLICATIONS

Despite their compounded length, the foregoing historical outline, survey of contemporary activity, and selected examples of ongoing research and theoretical efforts are still far from adequate to convey the full essence of this complex and contradictory field. Fortunately an extensive body of reference literature exists, including a number of comprehensive general volumes, whereby an interested reader may flesh out this sketch and extend it to many aspects not broached here [6], [44], [45], [56], [57], [92], [130], [238]–[242]. Hopefully, such more thorough study would tend to confirm the general impressions of the status and prospects of the field conveyed above. To restate these in summary, it appears that once the illegitimate research and invalid criticism have been set aside, the remaining accumulated evidence of psychic phenomena comprises an array of experimental observations, obtained under reasonable protocols in a variety of scholarly disciplines, which compound to a philosophical dilemma. On the one hand, effects inexplicable in terms of established scientific theory, yet having numerous common characteristics, are frequently and widely observed; on the other hand, these effects have so far proven qualitatively and quantitatively irreplicable, in the strict scientific sense, and appear to be sensitive to a variety of psychological and environmental factors that are difficult to specify,

let alone control. Under these circumstances, critical experimentation has been tedious and frustrating at best, and theoretical modeling still searches for vocabulary and concepts, well short of any useful formalisms.

Given these difficulties, what then are the motivations, if any, to proceed? As for most speculative topics, three potential generic benefits could be considered:

- a) acquisition of fundamental knowledge,
- b) practical applications,
- c) humanistic benefits.

In this particular field, basic knowledge might accrue in two ways—the attainment of new scientific information in the usual sense, and the broadening of scientific methodology to deal more effectively with irregular phenomena of this type. In other words, study of this topic not only might provide certain phenomenological answers, but also might serve to broaden the context in which science can formulate its questions. New mechanisms for transfer of information or energy might be identified, or broader understanding of those properties, and how they are perceived and measured might emerge. The latter half of the opportunity clearly is a major challenge to science, but hardly a new one. William James posed it rather bluntly some eighty-five years ago:

The spirit and principles of science are mere affairs of method; there is nothing in them that need hinder science from dealing successfully with a world in which personal forces are the starting point of new effects. The only form of thing that we concretely have is our own personal life. The only completed category of our thinking, our professors of philosophy tell us, is the category of personality, every other category being one of the abstract elements of that. And this systematic denial on science's part of personality as a condition of events, this rigorous belief that in its own essential and innermost nature our world is a strictly impersonal world, may, conceivably, as the whirligig of time goes round, prove to be the very defect that our descendants will be most surprised at in our boasted science, the omission that to their eyes will most tend to make it look perspectiveless and short [24].

The potential applications of psychic process are best considered with conservatism and restraint, especially given the tendency of certain elements of the public media and private exploiters to extrapolate the possibilities far beyond any demonstrated accomplishments. Clearly, the process of remote perception described earlier, along with other forms of clairvoyance, could hold some potential interest for intelligence agencies, law enforcement units, and any other activity relying on surveillance, as well as for archaeological searches, natural resource prospecting, and the like, and such operations have indeed engaged in empirical efforts to evaluate the efficacy of such strategies in their particular domains. From a strictly engineering standpoint, however, the potential efficiency and precision of such tactics are unclear, given their apparent tendency to trade more effectively in impressionistic generalities than in analytical detail.

Low-level PK effects, such as the REG distortions indicated above, could have more pervasive implications for high technology. If, for example, the basic functions of microelectronic elements could be even slightly disturbed by intentional or inadvertent intervention of human consciousness, it would seem important to obtain some assessment of the potential magnitude of such effects, and of the factors favoring or inhibiting such interference, before much more elaborate integrated circuit arrays, graphic display systems, and other sensitive man/machine interfaces are committed to delicate or critical opera-

tions. To focus our assessment of such possibilities, we are now examining PK disturbance of the memory function of a single microelectronic chip [243]. If the indications that psychological and environmental factors bear on the precipitation of such effects are sustained, it may be necessary to expand consideration of such parameters beyond the usual scope of human factors engineering, especially in situations involving high psychological stress.

The potential humanistic benefits of better comprehension of psychic phenomena could be addressed on either a personal or social level, but to do so in any detail would far exceed the purview of this article. Again, extensive references on various facets of the issue abound [244]–[252]. Ultimately, most of these philosophical excursions arrive at the same monumental question, namely whether convincing demonstration of the capability of human consciousness to influence its reality to a significant degree would substantially alter individual and collective perception of the human state, its value system, and its behavior pattern, and thereby facilitate its evolution to a higher life form. Such projections have been offered from a variety of perspectives. Engineer/futurist Willis Harman forecasts an "inner experience" paradigm:

Just as conventional science depends upon a prior consensus on how knowledge of the sense-perceived world shall be publicly tested and validated, so the complementary paradigm will have to include consensus on how knowledge relating to the world of inner experience shall be publicly tested and validated.

Its essential characteristic would be that consciousness and its contents are primary data, rather than being secondary and derivative as in the conventional paradigm. Where the conventional paradigm involves reductionistic models the complementary paradigm would add holistic models; where the first employs deterministic (or stochastic) explanations of events the second would add teleological, purpose-recognizing explanations; where the first is little involved with matters of values and meaning, the second finds these of central concern; where the first is dominated by technology-focused values of prediction and control, the second would tend to value understanding relating to human well-being, development and evolution [221].

Biologist/immunologist Jonas Salk phrases it more in terms of a resonance of human volition with natural processes:

Man has come to the threshold of a state of consciousness, regarding his nature and his relationship to the Cosmos, in terms that reflect 'reality.' By using the processes of Nature as metaphor, to describe the forces by which it operates upon and within Man, we come as close to describing 'reality' as we can within the limits of our comprehension. Men will be very uneven in their capacity for such understanding, which, naturally, differs for different ages and cultures, and develops and changes in the course of time. For these reasons it will always be necessary to use metaphor and myth to provide 'comprehensible' guides to living. In this way, Man's imagination and intellect play vital roles in his survival and evolution [249].

And philosopher/paleontologist Teilhard de Chardin states his hope in terms of a collective consciousness of the human race:

Thus we find ourselves in the presence, in actual possession, of the super-organism we have been seeking, of whose existence we were intuitively aware. The collective mankind which the sociologists needed for the furtherance of their speculations and formulations now appears scientifically defined, manifesting itself in its proper time and place, like an object entirely new and yet awaited in the sky of life. It remains for us to observe the world by the light it sheds, which throws into astonishing relief the great ensemble of everyday phenomena with which we have always lived, without perceiving their reality, their immediacy or their vastness [253].



On a somewhat less lofty, but possibly more functional level, a recent lengthy study prepared for the House of Representatives Science and Technology Committee, in a section encouraging serious assessment of further research on "the physics of consciousness," stated that recent experiments:

suggest that there exists an 'interconnectiveness' of the human mind with other minds and with matter; . . . that the human mind may be able to obtain the information independent of geography and time

and later concluded that:

. . . a general recognition of the degree of interconnectiveness of minds could have far-reaching social and political implications for this nation and the world [254].

The details and tones of these visions clearly are matters of individual heritage, experience, and intuition, but the messages share a common theme: the next stage in human evolution may involve expansion and interconnection of human consciousness, features clearly central to the psychic concept.

Beyond the difficulty of the phenomena and potential benefits of the knowledge, a more prosaic factor to be considered in contemplating further psychic research is the requisite cost of the effort. To date, such experimentation has been extraordinarily inexpensive by usual scientific standards. The primitive level of comprehension, the lack of organized interest within the established scientific communities, and the Bohemian status of many of the investigators have predicated projects of very low budgets compounding to a total annual national investment of the order of one million dollars or less [255]. Clearly, if more incisive progress is to be attempted, some increase in the sophistication and interaction of the principal programs must be funded, but it is most unlikely, and for the time probably undesirable, that this will consume any magnitude of resources comparable with, or distractive from, the better established research domains. A comparable statement could be made with respect to commitments of the requisite scholarly personnel.

If on the basis of such cost/risk/benefit considerations a modest ongoing program of research seems justified, it remains to consider the selection of topics, experimental styles, and evaluation criteria which would optimize the effort at this stage. In addition to the obvious desiderata that the specific experiments be clearly posed, conceptually simple, lend themselves logistically to rigorous, tightly controlled protocols, and focus on the more tractable and potentially applicable effects, three more specific recommendations could be offered.

First, given the irregularity of the phenomena, their possible dependence upon a broad range of physical, psychological, physiological, and environmental parameters, and their tendency to display effects as marginal deviations from some "normal" distributions, some premium should probably be placed on the capacity of the experiments for large data base accumulation and processing. While less prolific studies may continue to provide interesting anecdotal effects and suggest procedures for more detailed programs, it is unlikely that much correlation of those effects with pertinent prevailing parameters can be achieved without large quantities of data. More specifically, the favored experiments should 1) deal with processes found to have relatively high intrinsic yields; 2) employ equipment and protocols which permit data acquisition at rapid rates; and 3) have access to computational equipment and software which allow storage of large data arrays and processing of that data in many selective cross-concatenations. As an example, the latest refinement of the REG experiment described earlier allows acquisition, storage, and primary processing of several hundred experimental trials (~10<sup>5</sup> - 10<sup>6</sup> bits) per hour, and

subsequent concatenation of all previously stored data by any permutation of ten parametric indices, e.g., sampling rate, manual/automatic, volitional/instructed, operator characteristics, etc. For any such parametric explorations to be indicative, the pertinent data subset must be adequately large to display any systematic deviation from the baseline distribution beyond the statistical noise background. This we have found to require at least several thousand trials; the implication for the total data base is clear.

This very large data capability inevitably predicates a sophistication in equipment and software which, beyond the initial and operating expenses, may introduce some undesirable effects of complicating the phenomenological processes and clouding the experimental ambiances. Specifically, one needs to consider whether any observed effects, in either the PK or ESP categories, still trace unequivocally to the primary physical processes, or whether there now might arise confounding interactions with elements of the data collection and processing equipment or techniques. Related to this concern are possible uncertainties of the participants in defining and focusing on the primary tasks.

Reservations of this sort lead directly to a second general recommendation for effective psychic experimentation. Namely, if the phenomena derive to any significant degree from conscious or subconscious processes of the human mind, it is important that such not be inhibited or excessively complicated by the design and operation of the experiments. For this and numerous other reasons, it is probably essential in planning and implementing the experimental programs to include the insights, interpretations, and intuitions of the human operators, especially those who have demonstrated some success in the generation of the phenomena. It is quite possible that the difference between a sterile experiment and an effective one of equal rigor lies as much in the impressionistic aspects of its ambience and feedback as in the elegance of its instrumentation, and the former need to be well-tuned to the participants who are asked to function as components of the experimental system. On occasion, there seems to have been some tendency in this field to treat the experimental participants in rather perfunctory fashion, discounting any insights they might offer on the tasks at hand. If one subscribes at all to the concept of the phenomena emerging from some interpenetration of analytic and intuitive processes as suggested by the holistic models, there would seem no better place to combine perceptions and insights from these two domains than in the design, operation, and interpretation of the experiments addressed to illumination of the interface.

Finally, it seems most evident that given the intrinsic transdisciplinary nature of the business, research on this topic in any established sector should become much more communicative and interactive across traditional scholarly boundaries if it is to have any hope of rendering the phenomena into comprehensible and serviceable terms. This cross-talk cannot be limited to naturally contiguous fields, à la the usual exchange between physicist and engineer, or between psychologist and sociologist. As its lengthy heritage illustrates, in this domain the interests and insights of the theologian, philosopher, statistician, technologist, hard scientist, and creative holistic thinker are all potentially valid, and need to be melded in scholarly symbiosis and common respect. No insular approach is likely to prevail.

This requisite has implications for the staffing of particular projects, for the institutional environment in which they operate, and for the professional societies and publications which choose to attend to this topic. Individual laboratory personnel

groups should comprise a broader range of experience and insight than the conventional hierarchy of technical specialists, and their cognizance of other contemporary work should be broader. The institution housing that laboratory needs to display considerable tolerance and support for the unusual tone and special requirements of the research and not force its conformity to established scientific subdivisions and research styles. Likewise, the professional community at large cannot at this time profitably ask for total adherence to its own reductionistic superstructure, but can only inquire dispassionately regarding the respective implications of this conglomerate field for the traditional areas of endeavor.

In this last regard, I should like to express my personal respect for this particular Society, and for this particular Journal, for the openness and generosity of spirit with which they have solicited and presented the results of legitimate scholarly effort in this difficult field. Their attitude could well stand as a model for other institutions and organs in dealing with this topic or with any other present or future projective area of human inquiry.

#### ACKNOWLEDGMENT

The author would like to express his indebtedness to his research colleague, Ms. B. J. Dunne, who has provided immense logistical help in the preparation of this manuscript and who, as laboratory manager of the Princeton Engineering Anomalies Research program, has played a primary role in the generation and interpretation of much of the data reported herein. Dr. R. D. Nelson also contributed heavily to the experimental program and to the refinement of the manuscript. Prof. W. H. Surber designed much of the REG circuitry and software, and wrote the original programs for the remote perception analytical judging procedure.

The program has also benefitted immensely from the interests and efforts of several present and past students and staff, most notably C. K. Curry (Dunham), E. G. Jahn, T. A. Curtis, and I. A. Cook.

#### REFERENCES

- [1] M. Ebon, "A history of parapsychology," in *Psychic Exploration*, E. D. Mitchell et al., J. White, Ed. New York: Putnam, 1974.
- [2] A. Gould, *The Founders of Psychical Research*. New York: Schocken, 1968.
- [3] J. B. Rhine and associates, *Parapsychology from Duke to FRNM*. Durham, NC: Parapsychology Press, 1965.
- [4] H. Carrington, *The Story of Psychic Science (Psychical Research)*. New York: Ives Washburn, 1931.
- [5] R. C. LeClair, Ed., *The Letters of William James and Théodore Flournoy*. (Foreword by Gardner Murphy.) Madison, WI: University of Wisconsin Press, 1966.
- [6] B. B. Wolman, Ed., *Handbook of Parapsychology*. New York: Van Nostrand Reinhold, 1977.
- [7] D. S. Rogo, *Parapsychology: A Century of Inquiry*. New York: Taplinger, 1975.
- [8] F. Hartmann, *Paracelsus: Life and Prophecies*. Blauvelt, NY: Rudolf Steiner Publications, 1973, pp. 103-131.
- [9] M. Bell, "Francis Bacon: Pioneer in parapsychology," *Int. J. Parapsychol.*, VI, no. 2, pp. 199-208, Spring, 1964.
- [10] J. Glanvill, *Saducismus Triumphatus*, Introduction by C. O. Parsons, Facsimiles edit. Gainesville, FL: Scholars' Facsimiles and Reprints, 1966. (Originally published in 1689.)
- [11] R. Haynes, *Philosopher King—The Humanist Pope Benedict XIV*. London, England: Weidenfeld & Nicholson, 1970.
- [12] C. Richet, "La suggestion mentale et le calcul des probabilités," *Rev. Philosoph.*, 18, pp. 608-674, 1884.
- [13] C. Richet, "Further experiments in hypnotic lucidity or clairvoyance," in *Proc. Soc. for Psychical Research*, 6, pp. 66-83, 1889.
- [14] E. Swedenborg, *Divine Love and Wisdom*. New York: Swedenborg Foundation, Inc., 1979.
- [15] G. Trobridge, *Swedenborg, Life and Teaching*. New York: Swedenborg Foundation, Inc., 1976.
- [16] I. Ross, *The President's Wife, Mary Todd Lincoln*. New York: Putnam, 1973.
- [17] F.W.H. Myers, *Human Personality and the Survival of Bodily Death*, (Abridged and edited by S. Smith.) Secaucus, NJ: University Books, 1961. (Originally published in 1903, 2 vols.)
- [18] W. F. Barrett, "Appendix to the report on thought-reading," in *Proc. Soc. for Psychical Research*, 1, pp. 47-64, 1882.
- [19] O. J. Lodge, "An account of some experiments in thought-transference," in *Proc. Soc. for Psychical Research*, 2, pp. 189-200, 1884.
- [20] The American Society for Psychical Research, Inc., 5 W. 73 St., New York, NY 10023.
- [21] W. James, *Human Immortality: Two Supposed Objections to the Doctrine*. Boston, MA: Houghton Mifflin, 1898.
- [22] —, "Report of the Committee on Mediumistic Phenomena," in *Proc. American Soc. for Psychical Research*, 1, pp. 102-106, 1896.
- [23] G. Murphy and R. O. Ballou, *William James on Psychical Research*. New York: Viking Press, 1969.
- [24] W. James, "Psychical research," in *The Will to Believe and Other Essays in Popular Philosophy*. New York: Longmans, Green, and Co., 1897.
- [25] —, "Review of human personality and its survival of bodily death by F.W.H. Myers," in *Proc. Soc. for Psychical Research*, 18, p. 23, 1903.
- [26] S. Freud, "A note on the unconscious in psycho-analysis," in *Proc. Soc. for Psychical Research*, 26, pp. 312-318, 1912.
- [27] —, *Studies in Parapsychology*. New York: Collier Books, 1963.
- [28] C. G. Jung, *Synchronicity*. Princeton, NJ: Princeton University Press (Bollingen Series #20), 1973.
- [29] —, *On the Psychology and Pathology of So-Called Occult Phenomena*. Princeton, NJ: Princeton University Press (Bollingen Series #20), 1957. (Originally published in 1902, doctoral dissertation, University of Basel.)
- [30] —, *Memories, Dreams, Reflections*. (Recorded and edited by A. Jaffe, translated by Richard and Clara Winston.) New York: Vintage Books, 1965, p. 137.
- [31] W. Pauli and C. G. Jung, Eds., *The Interpretation of Nature and the Psyche*. Princeton, NJ: Princeton University Press (Bollingen Series #51), 1955.
- [32] J. Ehrenwald, "Psi, psychotherapy, and psychoanalysis," in *Handbook of Parapsychology*, B. B. Wolman, Ed. New York: Van Nostrand Reinhold, 1977, pp. 529-540.
- [33] M. Ullman, "Psychopathology and psi phenomena," in *Handbook of Parapsychology*, B. B. Wolman, Ed. New York: Van Nostrand Reinhold, 1977, pp. 557-574.
- [34] J. G. Pratt, J. B. Rhine, C. E. Stuart, and B. M. Smith, *Extra-Sensory Perception After Sixty Years*. New York: Holt, 1940.
- [35] J. B. Rhine, *New World of the Mind*. New York: William Morrow and Co., 1953.
- [36] J. B. Rhine, Ed., *Progress in Parapsychology*. Durham, NC: Parapsychology Press, 1971.
- [37] L. E. Rhine, *Mind Over Matter: Psychokinesis*. New York: Macmillan, 1970.
- [38] J. B. Rhine, "Psi and psychology: Conflict and solution," *J. Parapsychol.*, 32, pp. 101-128, 1968.
- [39] *Eur. J. Parapsychol., Int. J. Parapsychol.* (defunct), *J. Parapsychol., J. Amer. Soc. Psychical Research, J. Soc. for Psychical Research, Parapsychol. Rev., Proc. Soc. for Psychical Research*.
- [40] US Universities/Colleges: Chicago; Colorado; Columbia; CUNY; Delaware; Denver; Drexel; Duke; Finch; Harvard; Illinois; John F. Kennedy; Kent State; Michigan; Missouri; Mundelein; Newark College of Engineering; New School for Social Research; NYU; North Carolina; Oakland; Pittsburgh; Princeton; St. John's; St. Joseph's; South West Minnesota; Syracuse; UC/Berkeley; UC/Davis; UC/Irvine; UC/LA; UC/Santa Barbara; Virginia; Wesleyan; West Florida; West Georgia; Wisconsin; Yale. Foreign: Amsterdam; Andhra; Argentina; Benares; Bonn; Cambridge; Chile; Copenhagen; Edinburgh; Freiburg; Ghana; Halifax; Iceland; Jung Inst.; Leningrad; Leyden; London; Loyola; Lund; Mc Gill; Munich; Mysore; New South Wales; Oxford; Paris; Peking; Rhodes; South Africa; Tasmania; Tel Aviv; Utkal; Utrecht; Warsaw; Waterloo; Zurich.
- [41] List available upon request.
- [42] Research Institutions: Amer. Soc. for Psychical Research, New York; Ballistic Research Labs., Aberdeen, MD; Foundation for Research on the Nature of Man, Durham, NC; Inst. for Noetic Sciences, San Francisco, CA; Menninger Foundation, Topeka, KS; Midwest Psi Research Inst., Chicago, IL; Mind Science Foundation, San Antonio, TX; Parapsychology Foundation, NY; Psychical Research Foundation, Durham, NC; Psychophysical Research Labs, Princeton, NJ; Science Unlimited Research Foundation, San Antonio, TX; SRI International, Menlo Park,

- CA; Society for Psychical Research, London; Forschungsinstitut für Psychotronik, West Berlin; Matsui Hospital, Kasahara, Japan; Inst. of Pharmacology, Polish Academy of Sciences, Krakow; Shanghai Municipal Human Exception Functions Research Society. Corporations: Aresearch Company of California; Boeing Scientific Research Laboratories.
- [43] J. G. Pratt, "Soviet research in parapsychology," in *Handbook of Parapsychology*, B. B. Wolman, Ed. New York: Van Nostrand Reinhold, 1977, pp. 883-903.
- [44] E. K. Naumov and L. V. Vitenskaya, *Bibliographies on Parapsychology (Psychoenergetics) and Related Subjects*. Arlington, VA: Joint Publications Research Service, 1972. (Originally published in Moscow, 1971.)
- [45] E. K. Naumov and L. V. Vitenskaya, *Bibliography of Parapsychology (Psychotronics, Psychoenergetics, Psychobiophysics) and Related Problems*. (Literature published in the USSR), 1979 (in manuscript).
- [46] E. C. Wortz, A. J. Bauer, R. F. Blackwelder, J. W. Eerkins, and A. J. Sour, "An investigation of Soviet psychical research," in *Proc. Special Session: The State of the Art in Psychic Research; Electro 77 Professional Program*. New York: Apr. 19-21, 1977.
- [47] A. J. Lewis, *A Report*. Document EW-76-011, Aresearch Manufacturing Co. of California, January 1976. (A supplement to Wortz et al., #46 above.)
- [48] M. Johnson (Chairman) et al., "Symposium: Current directions in European parapsychology," in *Research in Parapsychology 1978*. Metuchen, NJ: Scarecrow Press, 1979, pp. 1-10.
- [49] S. Ostrander and L. Schroeder, *Psychic Discoveries Behind the Iron Curtain*. Englewood Cliffs, NJ: Prentice-Hall, 1970.
- [50] L. L. Vasiliev, *Experiments in Distant Influence* (Edited with Introduction by A. Gregory). New York: Dutton, 1976.
- [51] T. Moss, "Psychic research in the Soviet Union," in *Psychic Exploration*, E. D. Mitchell et al., J. White, Ed. New York: Putnam, 1974, pp. 469-486.
- [52] R. A. McConnell, "Parapsychology in the USSR," *J. Parapsychol.*, 39, pp. 129-134, 1975.
- [53] V. P. Zinchenko, A. N. Leont'yev, B. F. Lomov, and A. R. Luria, "Parapsychology: Fiction or reality?" *Voprosy Filosofii (Questions of Philosophy)*, 9, pp. 128-136, 1973.
- [54] Zhang Feng, "New advances made in study of exceptional human functions," *Shanghai Ziran Zazhi (Nature Journal)* in Chinese, no. 8, p. 606, Aug. 1980.
- [55] J. Palmer, "Attitudes and personality traits in experimental ESP research," in *Handbook of Parapsychology*, B. B. Wolman, Ed. New York: Van Nostrand Reinhold, 1977, pp. 175-201.
- [56] S. Krippner, Ed., *Advances in Parapsychological Research: II, Extrasensory Perception*. New York: Plenum Press, 1978.
- [57] K. R. Rao, *Experimental Parapsychology: A Review and Interpretation*. Springfield, IL: Charles C. Thomas, 1966.
- [58] G. Schmeidler, "The psychic personality," in *Psychic Exploration*, C. Mitchell et al., J. White, Ed. New York: Putnam, 1974.
- [59] H. J. Eysenck, "Personality and extrasensory perception," *J. Soc. Psychological Research*, 44, pp. 55-71, 1967.
- [60] G. R. Schmeidler and R. A. McConnell, *ESP and Personality Patterns*. Westport, CT: Greenwood Press, 1973 (originally published 1958).
- [61] J. Palmer, "Scoring in ESP tests as a function of belief in ESP. Part I. The sheep-goat effect," *J. Amer. Soc. Psychological Research*, 65, pp. 373-408, 1971.
- [62] A. Parker, *States of Mind: ESP and Altered States of Consciousness*. New York: Taplinger, 1975.
- [63] R. L. Van de Castle, "Sleep and dreams," in *Handbook of Parapsychology*, B. B. Wolman, Ed. New York: Van Nostrand Reinhold, 1977, pp. 473-499.
- [64] M. Ullman, S. Krippner, and A. Vaughan, *Dream Telepathy*. New York: Macmillan, 1973.
- [65] I. Strauch, "Dreams and psi in the laboratory," in *Psi Favorable States of Consciousness*, R. Cavanna, Ed. New York: Parapsychology Foundation, 1970, pp. 46-54.
- [66] C. Honorton, "Psi and internal attention states," in *Handbook of Parapsychology*, B. B. Wolman, Ed. New York: Van Nostrand Reinhold, 1977, pp. 435-472.
- [67] W. Braud, "Psi conducive conditions: Explorations and interpretations," in *Psi and States of Awareness: Proc. Int. Conf. held in Paris, France, Aug. 24-26, 1977*, B. Shapin and L. Coly, Eds. New York: Parapsychology Foundation, 1978.
- [68] E. Dingwall, Ed., *Abnormal Hypnotic Phenomena (4 Vols.)*. New York: Barnes and Noble, 1968.
- [69] C. Honorton and S. Krippner, "Hypnosis and ESP performance: A review of the experimental literature," in *Surveys in Parapsychology*, R. White, Ed. Metuchen, NJ: Scarecrow Press, 1976, pp. 227-270.
- [70] C. Sargent, "Hypnosis as a psi conducive state: A controlled replication study," *J. Parapsychol.*, 4, pp. 257-275, 1978.
- [71] C. Tart, "Drug induced states of consciousness," in *Handbook of Parapsychology*, B. B. Wolman, Ed. New York: Van Nostrand Reinhold, 1977, pp. 500-525.
- [72] J. Eccles, "The human person in its two-way relationship to the brain." Invited address to the Parapsychological Association Convention, State University of Utrecht, The Netherlands, Aug. 20, 1976. *Research in Parapsychology 1976*. Metuchen, NJ: Scarecrow Press, 1977, pp. 251-262.
- [73] J. Beloff, "ESP: The search for a physiological index," *J. Amer. Soc. Psychological Research*, 47, Sept. 1974.
- [74] J. Ehrenwald, "Psi phenomena and brain research," in *Handbook of Parapsychology*, B. B. Wolman, Ed. New York: Van Nostrand Reinhold, 1977, pp. 716-729.
- [75] D. Dean, "The plethysmograph as an indicator of ESP," *J. Soc. Psychological Research*, 41, pp. 351-353, 1962.
- [76] J. C. Carpenter, "Intrasubject and subject-agent effects in ESP experiments," in *Handbook of Parapsychology*, B. B. Wolman, Ed. New York: Van Nostrand Reinhold, 1977, pp. 202-272.
- [77] R. A. White, "The influence of experimenter motivation, attitudes, and methods of handling subjects on psi test results," in *Handbook of Parapsychology*, B. B. Wolman, Ed. New York: Van Nostrand Reinhold, 1977, pp. 273-301.
- [78] C. Honorton, M. Ramsey, and C. Cabibbo, "Experimenter effects in extrasensory perception," *J. Amer. Soc. Psychological Research*, 69, pp. 135-149, 1975.
- [79] G. Murphy, "Psychical research and human personality," *Proc. Soc. Psychological Research*, 48, pp. 1-15, 1949.
- [80] J. B. Rhine, "Conditions favoring success in psi tests," *J. Parapsychol.*, 12, pp. 58-75, 1948.
- [81] G. R. Schmeidler and M. Maher, "The non-verbal communications of psi-conducive and psi-inhibitory experimenters," *J. Amer. Soc. Psychological Research*, 75, pp. 241-257, 1981.
- [82] W. Crookes, *Crookes and the Spirit World*, collected by R. G. Medhurst. New York: Taplinger, 1972.
- [83] B. J. T. Dobbs, *The Foundations of Newton's Alchemy*. Cambridge, MA: Cambridge University Press, 1975, pp. 7-8.
- [84] C. Honorton, "Has science developed the competence to confront claims of the paranormal?" in *Research in Parapsychology 1975*. Metuchen, NJ: Scarecrow Press, 1976, pp. 199-223.
- [85] B. Musicante, *Experiments in Psychokinesis: Critique and Proposed Study*, Senior Thesis submitted to the Department of Psychology, Princeton University, May 1979.
- [86] R. Jungerman and J. Jungerman, "Computer controlled random number generator PK tests," in *Research in Parapsychology 1977*. Metuchen NJ: Scarecrow Press, 1978, pp. 157-162.
- [87] H. Schmidt, "A PK test with electronic equipment," *J. Parapsychol.*, 34, pp. 175-181, 1970.
- [88] H. Schmidt and L. Pantas, "Psi tests with internally different machines," *J. Parapsychol.*, 36, pp. 222-232, 1972.
- [89] H. Schmidt, "PK effect on pre-recorded targets," *J. Amer. Soc. Psychological Research*, 70, pp. 267-291, 1976.
- [90] —, "PK tests with pre-recorded and pre-inspected seed numbers," in *Research in Parapsychology 1980*. Metuchen, NJ: Scarecrow Press, 1981, pp. 47-50.
- [91] E. C. May, B. S. Humphrey, and G. S. Hubbard, "Electronic system perturbation techniques," SRI Int., Final Rep., Sept. 30, 1980.
- [92] S. Krippner, Ed. *Advances in Parapsychological Research, Vol. 1, Psychokinesis*. New York: Plenum Press, 1977.
- [93] B. Dunne, R. G. Jahn, and R. Nelson, "An REG experiment with large data-base capability," in *Research in Parapsychology 1981*. Metuchen, NJ: Scarecrow Press (in press).
- [94] H. Puthoff and R. Targ, *Mind-Reach*. New York: Delacorte, 1977.
- [95] —, "Physics, entropy, and psychokinesis," in *Quantum Physics and Parapsychology*, L. Oteri, Ed. New York: Parapsychological Foundation, 1975.
- [96] W. W. Eidsion, D. L. Faust, K. Getsla, J. McClay, and B. Conoway, "An investigation of possible anomalous interaction between a human being and a polarized laser beam," preliminary rep. on investigations June-Sept. 1977, Drexel University, Physics Dep. (unpublished.)
- [97] R. D. Nelson, B. J. Dunne, and R. G. Jahn, "Psychokinesis studies with a Fabry-Perot interferometer," in *Research in Parapsychology 1981*. Metuchen, NJ: Scarecrow Press (in press).
- [98] J. B. Hasted, "Physical aspects of paranormal metal bending," *J. Soc. Psychological Research*, 49, pp. 583-607, 1977.
- [99] —, *The Metal-Benders*. London, Boston and Henley: Routledge and Kegan Paul, 1981.
- [100] M. Ryzl, "A model for parapsychological communication," *J. Parapsychol.*, 30, pp. 18-31, 1966.
- [101] M. A. Persinger, "Geophysical models for parapsychological experiences," *Psychoenergetic Syst.*, 1, pp. 63-74, 1975.
- [102] G. E. Wolstenholme and E. C. P. Millar, Eds., *Extrasensory Perception: A CIBA Foundation Symposium*. New York: Citadel, 1966.
- [103] O. C. de Beaugard, "Time symmetry and interpretation of quantum mechanics," *Foundations Phys.*, 6, pp. 539-559, 1976.
- [104] G. Feinberg, "Possibility of faster-than light particles," *Phys. Rev.*, 159, p. 1089, 1967.

- [105] W. A. Tiller, "A lattice model of space and its relationship to multidimensional systems," in *Proc. A.R.E. Medical Symp.*, Phoenix, AZ, Jan. 1977.
- [106] L. Oteri, Ed., *Quantum Physics and Parapsychology: Proceedings of an International Conference held in Geneva, Switzerland, August 26-27, 1974*. New York: Parapsychological Foundation, 1975.
- [107] J.H.M. Whiteman, "Quantum theory and parapsychology," *J. Amer. Soc. for Psychical Research*, 67, pp. 341-360, 1973.
- [108] E. H. Walker, "Consciousness and quantum theory," in *Psychic Exploration*, E. D. Mitchell et al., J. White, Ed. New York: Putnam, 1974, pp. 544-568.
- [109] R. D. Mattuck, "A quantum mechanical theory of the interaction between consciousness and matter," *Colloque International "Science et Conscience"*, Cordoba, Spain, Oct. 1-5, 1979.
- [110] D. Bohm, "The enfolding-unfolding universe and consciousness," *Colloque International "Science et Conscience"*, Cordoba, Spain, Oct. 1-5, 1979.
- [111] H. Margenau, "ESP in the framework of modern science," *J. Amer. Soc. Psychical Research*, 60, pp. 214-228, 1966.
- [112] J.H.M. Whiteman, "Parapsychology and physics," in *Handbook of Parapsychology*, B. B. Wolman, Ed. New York: Van Nostrand Reinhold, 1977, pp. 730-756.
- [113] A. Puharich, Ed., *The Iceland Papers: Select Papers on Experimental and Theoretical Research on the Physics of Consciousness*. Foreword by B. D. Josephson. Amherst, WI: Essentia Research Associates, 1979.
- [114] A. H. Klopff, *Mental and Physical Phenomena: Toward a Unified Theory*. July 1977. (Unpublished manuscript.)
- [115] Duke University, Dep. of Electrical Engineering; Princeton University, School of Engineering/Applied Science; Syracuse University, School of Computer and Information Science.
- [116] S. S. Wilks, "Statistical aspects of experiments in telepathy," H.C.L.R. Lieber, Ed. A lecture by Samuel S. Wilks given at the Galois Institute of Mathematics, Long Island University, Mimeographed, 1938, 18 pp.
- [117] P. Diaconis, "Statistical problems in ESP research," *Science*, 201, pp. 131-136, July 14, 1978.
- [118] C.E.M. Hansel, *ESP and Parapsychology: A Critical Reevaluation*. Buffalo, NY: Prometheus Books, 1980.
- [119] D. S. Burdick and E. F. Kelly, "Statistical Methods in Parapsychological Research," in *Handbook of Parapsychology*, B. B. Wolman, Ed. New York: Van Nostrand Reinhold, pp. 81-130, 1977.
- [120] J. A. Greenwood and C. E. Stuart, "Mathematical techniques used in ESP research," *J. Parapsychol.*, 1, pp. 206-225, 1937.
- [121] W. W. Carington, "Experiments on the paranormal cognition of drawings," *J. Parapsychol.*, 4, pp. 1-134, 1940.
- [122] L. L. Gatlin, "A new measure of bias in finite sequences with applications to ESP data," *J. Amer. Soc. Psychical Research*, 1, pp. 29-43, 1979.
- [123] C. T. Tart, "Randomicity, predictability, and mathematical inference strategies in ESP feedback experiments" (Discussion of Dr. Gatlin's paper). *J. Amer. Soc. Psychical Research*, 1, pp. 44-60, 1979.
- [124] J. G. Pratt, "Is ESP only a misnomer for response sequences chosen to match inferred target sequences?" (Discussion of Dr. Gatlin's paper.) *J. Amer. Soc. Psychical Research*, 1, pp. 60-66, 1979.
- [125] D. S. Rogo, *Parapsychology: A Century of Inquiry*. New York: Taplinger, 1975, pp. 29-30.
- [126] H. Bergson, "Presidential address to the Society for Psychical Research (1913)," *Proc. Soc. Psychical Research*, 27, pp. 157-175, 1914.
- [127] —, *Mind Energy*. New York: Henry Holt, 1920.
- [128] C. D. Broad, *Religion, Philosophy and Psychical Research*. New York: Humanities Press, 1969.
- [129] J. Ludwig, Ed., *Philosophy and Parapsychology*. Buffalo, NY: Prometheus Books, 1978.
- [130] G. R. Schmeidler, Ed., *Parapsychology: Its Relation to Physics, Biology, Psychology, and Psychiatry*. Metuchen, NJ: Scarecrow Press, 1976.
- [131] R. L. Van de Castle, "Parapsychology and anthropology," in *Handbook of Parapsychology*, B. B. Wolman, Ed. New York: Van Nostrand Reinhold, 1977, pp. 667-686.
- [132] R. L. Morris, "Parapsychology, biology, and anpsi," in *Handbook of Parapsychology*, B. B. Wolman, Ed. New York: Van Nostrand Reinhold, 1977, pp. 687-715.
- [133] W. H. Clark, "Parapsychology and religion," in *Handbook of Parapsychology*, B. B. Wolman, Ed. New York: Van Nostrand Reinhold, 1977, pp. 769-780.
- [134] J. M. Backus, "Parapsychology and Literature," in *Handbook of Parapsychology*, B. B. Wolman, Ed. New York: Van Nostrand Reinhold, 1977, pp. 781-802.
- [135] C. Panati, Ed., *The Geller Papers: Scientific Observations on the Paranormal Powers of Uri Geller*. Boston, MA: Houghton Mifflin, 1976.
- [136] C. Crussard and J. Bouvaist, "Study of certain seemingly abnormal deformations and transformations of metals," *Memoires Scientifiques Revue Metallurgie*, Feb. 1978. (English translation H & P de Maigret, Nov. 1978).
- [137] J. G. Pratt, *ESP Research Today: A Study of Developments in Parapsychology since 1960*. Metuchen, NJ: Scarecrow Press, 1973.
- [138] J. G. Pratt, "The Pearisburg poltergeist," in *Research in Parapsychology 1977*. Metuchen, NJ: Scarecrow Press, 1978, pp. 174-182.
- [139] J. Krieger, D. DalCorso, and G. Solfvin, "RSPK in Philadelphia," in *Research in Parapsychology 1978*. Metuchen, NJ: Scarecrow Press, 1979, pp. 59-60.
- [140] A.R.G. Owen, *Can We Explain the Poltergeist?* New York: Garrett Helix, 1964.
- [141] W. G. Roll, *The Poltergeist*. Metuchen, NJ: Scarecrow Press, 1976.
- [142] W. G. Roll, "Poltergeists," in *Handbook of Parapsychology*, B. B. Wolman, Ed. New York: Van Nostrand Reinhold, 1977, pp. 382-413.
- [143] W. Tiller, "A technical report on some psychoenergetic devices," *A.R.E. J.*, 7, p. 81, 1972.
- [144] G. Schmeidler, "PK effects upon continuously recorded temperature," *J. Amer. Soc. Psychical Research*, 67, p. 325, 1973.
- [145] R. G. Stanford, "Experimental psychokinesis: A review from diverse perspectives," in *Handbook of Parapsychology*, B. B. Wolman, Ed. New York: Van Nostrand Reinhold, 1977, pp. 324-381.
- [146] H. Schmidt, "Psychokinesis," in *Psychic Exploration*, E. D. Mitchell et al., J. White, Ed. New York: Putnam, 1974, pp. 179-193.
- [147] W. Cox, "The effect of PK on the placement of falling objects," *J. Parapsychol.*, 15, pp. 40-48, 1951.
- [148] —, "The effect of PK on electromechanical systems," *J. Parapsychol.*, 29, pp. 165-175, 1965.
- [149] J. Hasted, *The Metal Benders*. London, Boston and Henley: Routledge and Kegan Paul, 1981, p. 131.
- [150] M. G. Shafer, "PK metal bending in a semi-formal small group," in *Research in Parapsychology 1980*. Metuchen, NJ: Scarecrow Press, 1981, pp. 32-35.
- [151] C. Honorton and L. Tremmel, "Psitrek: A preliminary effort toward development of psi-conductive computer software," *Research in Parapsychology 1979*. Metuchen, NJ: Scarecrow Press, 1980, pp. 159-160.
- [152] U. Sinclair, *Mental Radio* (Rev. 2nd printing, Introduction by W. McDougall, Preface by A. Einstein, with a report by W. F. Prince). Springfield, IL: Charles C. Thomas, 1962.
- [153] H. E. Puthoff and R. Targ, "A perceptual channel for information transfer over kilometer distances: Historical perspective and recent research," in *Proc. IEEE*, vol. 64, pp. 329-354, 1976.
- [154] R. Targ and H. E. Puthoff, "Information, transmission under conditions of sensory shielding," *Nature*, 252, pp. 602-607, 1974.
- [155] C. T. Tart, H. E. Puthoff, and R. Targ, Eds., *Mind at Large: IEEE Symposia on the Nature of Extrasensory Perception*. New York: Praeger Special Studies, 1979.
- [156] H. E. Puthoff, R. Targ, and E. C. May, "Experimental psi research: Implication for physics," in *The Role of Consciousness in the Physical World*, R. G. Jahn, Ed. Boulder, CO: Westview Press, 1981, pp. 37-86.
- [157] B. J. Dunne and J. P. Bisaha, "Precognitive remote viewing in the Chicago area," *J. Parapsychol.*, 43, pp. 17-30, 1979.
- [158] —, "Multiple subject precognitive remote viewing," in *Research in Parapsychology 1977*. Metuchen, NJ: Scarecrow Press, 1978, pp. 146-151.
- [159] —, "Long distance precognitive remote viewing," in *Research in Parapsychology 1978*. Metuchen, NJ: Scarecrow Press, 1979, pp. 68-70.
- [160] J. P. Bisaha and B. J. Dunne, "Long distance and multiple subject precognitive remote viewing of geographical locations," in *Mind at Large: IEEE Symposia on the Nature of Extrasensory Perception*, C. T. Tart, H. E. Puthoff, and R. Targ, Eds. New York: Praeger Special Studies, 1979, pp. 107-124.
- [161] B. J. Dunne, *Precognitive Remote Perception*. M.A. thesis, Committee on Human Development, University of Chicago, 1979.
- [162] B. J. Dunne and J. P. Bisaha, "Precognitive remote perception: A critical overview of the experimental program," in *Research in Parapsychology 1979*. Metuchen, NJ: Scarecrow Press, 1980, pp. 117-120.
- [163] R. G. Jahn, "Psychic process, energy transfer, and things that go bump in the night," *Princeton Alumni Weekly*, Dec. 4, 1978, S-1-12.
- [164] E. A. Rauscher, G. Weissmann, J. Sarfatti, and S.-P. Sirag, "Remote perception of natural scenes, shielded against ordinary perception," in *Research in Parapsychology 1975*. Metuchen, NJ: Scarecrow Press, 1976.

- NJ: Scarecrow Press, pp. 41-45, 1976.
- [165] S. Allen, P. Green, K. Rucker, R. Cohen, C. Goolsby, and R. L. Morris, "A remote viewing study using a modified version of the SRI procedure," in *Research in Parapsychology 1975*. Metuchen, NJ: Scarecrow Press, 1976, pp. 46-48.
- [166] A. C. Hastings and D. B. Hurt, "A confirmatory remote viewing experiment in a group setting," *Proc. IEEE*, vol. 64, pp. 1544-1545, 1976.
- [167] J. Vallee, A. C. Hastings, and G. Askevold, "Remote viewing through computer conferencing," *Proc. IEEE*, vol. 64, p. 1551, 1976.
- [168] T. W. Whitson, D. N. Bogart, J. Palmer, and C. T. Tart, "Preliminary experiments in group remote viewing," *Proc. IEEE*, vol. 64, p. 1550, 1976.
- [169] H. Chotas, "Remote viewing in the Durham area," *J. Parapsychol.*, 1, pp. 61-62, 1978.
- [170] M. Schlitz and S. Deacon, "Remote viewing: A conceptual replication of Targ and Puthoff," in *Research in Parapsychology 1979*. Metuchen, NJ: Scarecrow Press, 1980, pp. 124-126.
- [171] E. Karnes and E. Sussman, "Remote viewing: A response bias interpretation," *Psycholog. Rep.*, 44, pp. 471-479, 1979.
- [172] E. Karnes, J. Ballou, E. Sussman, and F. Swaroff, "Remote viewing: Failures to replicate with control comparisons," *Psycholog. Rep.*, 45, pp. 963-973, 1979.
- [173] E. W. Karnes, E. P. Sussman, P. Klusman, and L. Turcotte, "Failures to replicate remote viewing using psychic subjects," *Zetetic Scholar*, 6, pp. 66-76, 1980.
- [174] M. Schlitz and E. Gruber, "Transcontinental remote viewing," *J. Parapsychol.*, 4, pp. 305-317, 1980.
- [175] C. Scott, "On the evaluation of verbal material in parapsychology: A discussion of Dr. Pratt's monograph," *J. Soc. Psychical Research*, 46, pp. 79-90, 1972.
- [176] R. L. Morris, "An exact method for evaluating preferentially matched free-response material," *J. Amer. Soc. Psychical Research*, 66, p. 401, 1972.
- [177] G. Solfvin, E. Kelly, and D. Burdick, "Some new methods of analysis for preferential ranking data," *J. Amer. Soc. Psychical Research*, 72, p. 93, 1978.
- [178] D. Marks and R. Kammann, *The Psychology of the Psychic*. Buffalo, NY: Prometheus Books, 1980.
- [179] R. G. Jahn, B. J. Dunne, E. G. Jahn, "Analytical judging procedure for remote perception experiments," *J. Parapsychol.*, 3, pp. 207-231, 1980.
- [180] B. J. Winer, *Statistical Principles in Experimental Design*. New York: McGraw-Hill, 1962, pp. 43-45.
- [181] R. G. Jahn, Ed., *The Role of Consciousness in the Physical World*. Boulder, CO: Westview Press, 1981.
- [182] R. G. Stanford, "An experimentally testable model for spontaneous psi events. I. Extrasensory events," *J. Amer. Soc. Psychical Research*, 68, pp. 34-57, 1974. "II. Psychokinetic events," *Ibid*, pp. 321-356.
- [183] C. T. K. Chari, "Some generalized theories and models of psi: A critical evaluation," in *Handbook of Parapsychology*, B. B. Wolman, Ed. New York: Van Nostrand Reinhold, 1977, pp. 803-822.
- [184] R. G. Stanford, "Conceptual frameworks of contemporary psi research," in *Handbook of Parapsychology*, B. B. Wolman, Ed. New York: Van Nostrand Reinhold, 1977, pp. 823-858.
- [185] B. B. Wolman, "Mind and body: A contribution to a theory of parapsychological phenomena," in *Handbook of Parapsychology*, B. B. Wolman, Ed. New York: Van Nostrand Reinhold, 1977, pp. 861-879.
- [186] A. M. Young, *The Geometry of Meaning*. New York: Delacorte Press/Seymour Lawrence, 1976.
- [187] B. Shapin and L. Coly, Eds., *Concepts and Theories of Parapsychology: Proceedings of an International Conference held in New York, NY, Dec. 6, 1980*. New York: Parapsychology Foundation, Inc., 1981.
- [188] F. Cazzamalli, "Phénomènes télépsychiques et radiations cérébrales," *Rev. Métapsych.*, 4, p. 3, 1925.
- [189] I. M. Kogan, "Is telepathy possible?" *Radio Eng.*, 21, p. 75, 1966. —, "Telepathy, hypotheses and observations," *Radio Eng.*, 22, p. 141, 1967. —, "Information theory analysis of telepathic communication experiments," *Radio Eng.*, 23, p. 122, 1968.
- [190] M. A. Persinger, "ELF field mediation in spontaneous psi events: Direct information transfer or conditional elicitation?" in *Mind at Large*, C. T. Tart, H. E. Puthoff, and R. Targ, Eds. New York: Praeger Special Studies, 1979, pp. 189-204.
- [191] L. L. Gatlin, *Information Theory and the Living System*. New York: Columbia University Press, 1972.
- [192] W. von Lucadou and K. Kornwachs, "Development of the system-theoretic approach to psychokinesis," paper presented at the Parascience Conf., London, 1979.
- [193] K. Kornwachs and W. von Lucadou, "Psychokinesis and the concept of complexity," *Psychoenergetic Syst.*, 3, pp. 327-342, 1979.
- [194] G. Feinberg, "Precognition—A memory of things future," in *Quantum Physics and Parapsychology*, L. Oteri, Ed. New York: Parapsychology Foundation, 1975, pp. 54-64.
- [195] E. A. Rauscher, "Some physical models potentially applicable to remote perception," in *The Iceland Papers*, A. Puharich, Ed. Amherst, WI: Essentia Research Associates, 1979, pp. 49-83.
- [196] A. S. Eddington, *Space, Time and Gravitation: An Outline of the General Theory of Relativity*. Cambridge, MA: Cambridge University Press, 1920, pp. 198-201.
- [197] A. S. Eddington, *The Nature of the Physical World*. Cambridge, MA: Cambridge University Press, 1928, p. 276.
- [198] K. Pribram, *Languages of the Brain*. Englewood Cliffs, NJ: Prentice-Hall, 1971.
- [199] K. Pribram, "Toward a holonomic theory of perception," in *Gestalttheorie Modernen Psychologie*, S. Ertel, Ed. Darmstadt: Steinkopff, 1975.
- [200] K. Pribram, "Problems concerning the structure of consciousness," in *Consciousness and the Brain*, G. Globus, Ed. New York: Plenum Press, 1976.
- [201] D. Bohm, "Quantum theory as an indication of a new order in physics. Part A. The development of new orders as shown through the history of physics," *Foundations Phys.*, 1, pp. 359-381, 1971.
- [202] D. Bohm, "Quantum theory as an indication of a new order in physics. Part B. Implicate and explicate order in physical law," *Foundations Phys.*, 1, pp. 139-168, 1971.
- [203] A. Eddington, *Relativity Theory of Protons and Electrons*. New York: York: Macmillan, 1936, p. 329.
- [204] O. C. de Beauregard, "The expanding paradigm of the Einstein paradox," in *The Iceland Papers*, A. Puharich, Ed. Amherst, WI: Essentia Associates, 1979, pp. 162-191.
- [205] E. P. Wigner, "On hidden variables and quantum mechanical probabilities," *Amer. J. Phys.*, 38, p. 1005, 1970.
- [206] J. S. Bell, "On the problem of hidden variables in quantum mechanics," *Rev. Modern Phys.*, 38, p. 447, 1966.
- [207] D. Bohm and J. Bub, "A proposed solution of the measurement problem in quantum mechanics by a hidden variable theory," *Rev. Modern Phys.*, 38, p. 453, 1966.
- [208] J. Mehra, "Quantum mechanics and the explanation of life," *Amer. Scientist*, 61, pp. 722-728, 1973.
- [209] E. H. Walker, "Foundations of parapsychical and parapsychological phenomena," in *Quantum Physics and Parapsychology*, L. Oteri, Ed. New York: Parapsychology Foundation, 1975, pp. 1-44.
- [210] R. G. Jahn and B. J. Dunne, "A quantum mechanical approach to the representation of paranormal phenomena," 1982 (to be published).
- [211] T. N. E. Greville, "Are psi events random?" *J. Amer. Soc. Psychical Research*, 74, pp. 223-226, 1980.
- [212] J. A. Greenwood and T. N. E. Greville, "On requirements for using statistical analysis in psi experiments," *J. Parapsychol.*, 43, pp. 315-321, 1979.
- [213] R. Jahn and B. Dunne, "Physical models of psychic process," in *Concepts and Theories of Parapsychology*, B. Shapin and L. Coly, Eds. New York: Parapsychology Foundation, Inc., 1981, pp. 69-79.
- [214] R. May, "Creativity and encounter," in *The Creative Imagination*, H. M. Ruitenbeek, Ed. Chicago, IL: Quadrangle Books, 1965, pp. 283-291.
- [215] F. Barron, "The needs for order and disorder as motives in creative activity," in the second (1957) University of Utah research conference on the identification of creative scientific talent, C. W. Taylor, Ed. Salt Lake City: University of Utah Press, 1958, pp. 119-128.
- [216] D. McClelland, "The calculated risk: An aspect of scientific performance," in *Scientific Creativity, its Recognition and Development*, C. W. Taylor and F. Barron, Eds. New York: Wiley, 1963, pp. 184-192.
- [217] S. D. Drell, "When is a particle?" *Phys. Today*, 31, pp. 23-32, 1978.
- [218] W. Heisenberg, "The nature of elementary particles," *Phys. Today*, 29, pp. 32-39, 1976.
- [219] F. Capra, Paper LBL-796, Lawrence Berkeley Laboratories, University of California, Berkeley, CA, 1978.
- [220] J. A. Wheeler, "The universe as home for man," *Amer. Scientist*, 62, pp. 683-691, 1974.
- [221] W. W. Harman, "Broader implications of recent findings in psychological and psychic research," in *The Role of Consciousness in the Physical World*, R. G. Jahn, Ed. Boulder, CO: Westview Press, 1981, pp. 113-131.
- [222] A. Angoff and B. Shapin, Eds., *A Century of Psychical Research: The Continuing Doubts and Affirmations*. New York: Parapsychology Foundation, 1971.
- [223] C. A. Murchison, Ed. *The Case For and Against Psychical Belief*. New York: Arno Press, 1975. (Originally published in 1927.)
- [224] W. F. Prince, *The Enchanted Boundary*. New York: Arno Press,

1975. (Originally published in 1930.)
- [225] K. M. Goldney and S. G. Soal, "Report on a series of experiments with Mrs. Eileen Garrett," *Proc. Soc. Psychical Research*, 45, pp. 43-87, 1938.
- [226] J. Beloff, "The 'sweethearts' experiment," *J. Soc. Psychical Research*, 45, pp. 1-7, 1969.
- [227] M. Maher, D. Peratsakis, and G. R. Schmeidler, "Cerebral localization effects in ESP processing: An attempted replication," *J. Amer. Soc. for Psychical Research*, 73, pp. 167-177, 1979.
- [228] S. Blackmore, "Correlation between ESP and memory," *Eur. J. Parapsychol.*, 3, pp. 127-147, 1980.
- [229] J. Eisenbud, L. Hassel, H. Keely, and W. Sawrey, "A further study of teacher-pupil attitudes and results on clairvoyance tests in the fifth and sixth grades," *J. Amer. Soc. Psychical Research*, 54, pp. 72-80, 1960.
- [230] E. Belvedere and D. Foulkes, "Telepathy and dreams: A failure to replicate," *Perceptual Motor Skills*, 33, pp. 783-789, 1971.
- [231] J. Beloff and D. Bate, "An attempt to replicate the Schmidt findings," *J. Soc. Psychical Research*, 46, pp. 21-31, 1971.
- [232] R. G. Jahn, reply to Bradley Dowden, *Zetetic Scholar*, 7, p. 127, 1980.
- [233] C. C. Gillispie, Ed., *Dictionary of Scientific Biography*. New York: Scribner's, 1970-1980.
- [234] R. L. Weber, *A Random Walk in Science*, E. Mendoza, Ed., Foreword by W. Cooper. New York: Crane, Russak, 1973, pp. 66-67.
- [235] R. S. deRopp, *The New Prometheans*. New York: Delacorte, 1972, p. 2-28.
- [236] L. Barnett, *The Universe and Dr. Einstein* (Rev. edit.). New York: The New American Library, 1952, p. 117.
- [237] R. G. Jahn, "Psychic research: New dimensions or old delusions?" *Zetetic Scholar*, 6, pp. 5-16, 1980.
- [238] J. Beloff, Ed., *New Directions in Parapsychology*. Metuchen, NJ: Scarecrow Press, 1975.
- [239] J. B. Rhine and J. G. Pratt, *Parapsychology: Frontier Science of the Mind* (Rev. edit.). Springfield, IL: Charles C. Thomas, 1962.
- [240] R. A. White, Ed., *Surveys in Parapsychology*. Metuchen, NJ: Scarecrow Press, 1976.
- [241] R. A. White and L. A. Dale, *Parapsychology: Sources of Information*. Metuchen, NJ: Scarecrow Press, 1973. (Rev. edit. by R. A. White in preparation.)
- [242] N. Bowles and F. Hynds with J. Maxwell, *Psi Search*. San Francisco, CA: Harper and Row, 1978.
- [243] R. G. Jahn, B. J. Dunne, R. Nelson, and H. Mertz, "Anomalous operator influence on elementary microelectronic devices," Tech. note, School of Engineering/Applied Science, Princeton University, 1981.
- [244] J. Bronowski, *Science and Human Values*. New York: Harper and Brothers, 1956.
- [245] M. Polanyi, *Personal Knowledge*. Chicago, IL: University of Chicago Press, 1962.
- [246] A. Korzybski, *Science and Sanity: An Introduction to Non-Aristotelian Systems and General Semantics*. Clinton, MA: The Colonial Press, 1933.
- [247] W. Penfield, *The Mystery of the Mind*. Princeton, NJ: Princeton University Press, 1975.
- [248] M. Ferguson, *The Aquarian Conspiracy*. Los Angeles, CA: J. P. Tarcher, 1980.
- [249] J. Salk, *Survival of the Wisest*. New York: Harper and Row, 1973.
- [250] A. M. Young, *The Reflexive Universe*. New York: Delacorte Press, 1976.
- [251] E. Jantsch, *The Self-Organizing Universe: Scientific and Human Implications of the Emerging Paradigms of Evolution*. Elmsford, NY: Pergamon Press, 1980.
- [252] D. Dean et al., *Executive ESP*. Englewood Cliffs, NJ: Prentice-Hall, 1974.
- [253] P. T. de Chardin, *The Future of Man*. New York: Harper and Row, 1964 (pp. 166-167 in Harper Torchbooks edit.).
- [254] Report to the House of Representatives, Committee on Science and Technology, June 1981.
- [255] C. T. Tart, "A survey of expert opinion on potentially negative uses of psi, United States government interest in psi, and the level of research funding of the field," in *Research in Parapsychology 1978*. Metuchen, NJ: Scarecrow Press, 1979, pp. 54-55.