

**SECRET**

(10)

8 May 1979

PROPOSED GRILL FLAME PROTOCOL: TASK II

PROPOSED SRI INTERNATIONAL PROTOCOL FOR RESEARCH  
ON REMOTE PERTURBATION TECHNIQUES

**WARNING NOTICE - Intelligence Sources  
and Methods Involved**

**— NOT RELEASABLE TO FOREIGN NATIONALS —**

SRI 9-4186

Copy No. 1

**SECRET**

This document is made available through the declassification efforts  
and research of John Greenewald, Jr., creator of:

# The Black Vault



The Black Vault is the largest online Freedom of Information Act (FOIA) document clearinghouse in the world. The research efforts here are responsible for the declassification of hundreds of thousands of pages released by the U.S. Government & Military.

**Discover the Truth** at: <http://www.theblackvault.com>

**SECRET**

8 May 1979

PROPOSED GRILL FLAME PROTOCOL: TASK II (S)

PROPOSED SRI INTERNATIONAL PROTOCOL FOR RESEARCH  
ON REMOTE PERTURBATION TECHNIQUES (S)

CLASSIFIED BY: Msg, 7 Jul 78,  
DA (DAMI-ISH), Wash., D.C.  
REVIEW ON: 7 Jul 1998

**WARNING NOTICE - Intelligence Sources  
and Methods Involved**

**NATIONAL SECURITY INFORMATION  
Unauthorized Disclosure Subject  
to Criminal Sanctions**

SRI 9-4186

This document consists  
of 84 pages.

Copy No. 1

**- NOT RELEASABLE TO FOREIGN NATIONALS -**



333 Ravenswood Ave. • Menlo Park, California 94025  
(415) 326-6200 • Cable: STANRES, Menlo Park • TWX: 910-373-1246

**SECRET**

**SRI International**

~~SECRET~~

## CONTENTS

I	INTRODUCTION . . . . .	1
	A. General . . . . .	1
	1. Military Objective . . . . .	1
	2. Military Applications . . . . .	1
	3. Approval History . . . . .	2
	4. Project Officers . . . . .	2
	B. Early Demonstrations with Ingo Swann. . . . .	3
	C. Data Base for RNG Experiments . . . . .	6
	1. Early Experiments. . . . .	6
	2. Total RNG Data Base. . . . .	7
	3. Critique of Data Base. . . . .	7
	D. Scientific Merits . . . . .	10
	E. Technical Application . . . . .	11
II	EXPERIMENTS. . . . .	12
	A. General . . . . .	12
	B. Assumptions . . . . .	12
	C. Independent Variables . . . . .	13
	D. Dependent Variables . . . . .	13
	E. Hardware. . . . .	13
	1. Random Sources . . . . .	13
	2. Analysis . . . . .	15
	3. Display. . . . .	18
	4. Hardware Redundancy. . . . .	18
III	PARTICIPANTS . . . . .	19
	A. Selection Criteria. . . . .	19
	B. Payment Criteria. . . . .	19
	C. Experiment Duration . . . . .	19
	D. Number of Participants. . . . .	19

~~SECRET~~

**UNCLASSIFIED**

E.	Volunteer Consent Form . . . . .	20
F.	Medical Facilities . . . . .	22
	1. Personal Injuries . . . . .	22
	2. Emergency Response Program . . . . .	22
	3. Insurance Coverage . . . . .	24
G.	Debriefing Schedule . . . . .	25
	1. Session Debriefing . . . . .	25
	2. Experiment Debriefing . . . . .	25
	3. Specific Debriefing Protocols . . . . .	25
IV	INVESTIGATION ANALYSIS CRITERIA . . . . .	26
V	ENVIRONMENT . . . . .	27
	REFERENCES . . . . .	28
	APPENDICES	
A	A PK TEST WITH ELECTRONIC EQUIPMENT . . . . .	30
B	A PERCEPTUAL CHANNEL FOR INFORMATION TRANSFER OVER KILOMETER DISTANCES: HISTORICAL PERSPECTIVE AND RECENT RESEARCH . . . . .	38
C	BIOGRAPHIES OF KEY PERSONNEL . . . . .	65

**UNCLASSIFIED**

~~SECRET~~

PROPOSED GRILL FLAME PROTOCOL: TASK II  
PROPOSED SRI INTERNATIONAL PROTOCOL FOR RESEARCH  
ON REMOTE PERTURBATION TECHNIQUES

I INTRODUCTION

A. General

This protocol contains the procedure for MIA-sponsored SRI International research on remote perturbations. It is to remain in effect for the contractual period. The term "remote perturbation (RP)" is used herein to signify an intellectual/mental process by which a person perturbs remote sensitive apparatus or equipment. RP does not involve any electronic sensing devices at, or focused on, the RP agent. No drugs, hypnosis, special sensory (visual, auditory or olfactory) or proprioceptive stimuli, liminal, or subliminal, electrical, or electromagnetic will be used in this protocol.

1. Military Objective

It is the objective of this protocol to determine whether targeted sensitive electronic equipment can be perturbed as a result of RP activity.

2. Military Applications

RP offers the potential for remote man/machine interactions with computers, locks, switches, codes, and other sensitive or delicate mechanical or electronic apparatus, barred or held secure from ordinary physical contact or intervention.

~~SECRET~~

~~SECRET~~

3. Approval History

The Commander, U.S. Army Materiel Development and Readiness Command (DARCOM) approved in principle the U.S. Army involvement in what is now known as project GRILL FLAME in April 1978. In May 1978, the Assistant Chief of Staff for Intelligence (ACSI) accepted lead responsibility for GRILL FLAME applications. Overall DoD responsibility resides with the Defense Intelligence Agency (DIA).

4. Project Officers

The overall, responsible individuals for all aspects of the project at SRI International are Dr. Edwin C. May, Dr. Harold Puthoff, and Mr. Russell Targ.

~~SECRET~~

B. Early Demonstrations with Ingo Swann

One of the first psychoenergetically produced physical effects observed by SRI personnel in early research (1972) was the apparent perturbation of a superconductor-shielded Josephson effect magnetometer by a gifted subject, Mr. Ingo Swann. Following is a fairly detailed account of that first observation, since it reveals a number of aspects of remote perturbation (RP) research that we consider to be of significance.

This magnetometer is located in a well under a building and is shielded by  $\mu$ -metal shielding, an aluminum container, copper shielding, and, most important, a superconducting niobium shield. (See Figure 1.) The magnetometer is of the superconducting quantum interference device (SQUID) variety, which has an output voltage whose frequency is a measure of the rate of change of magnetic field present.

Before the experiment, a decaying magnetic field had been set up inside the magnetometer, and its decay with time provided a background calibration signal that registered as a periodic output on an x-y recorder, the frequency of the output corresponding to the decay rate of the calibration field ( $\sim 10^{-6}$  G). The system had been running for about an hour with no noise.

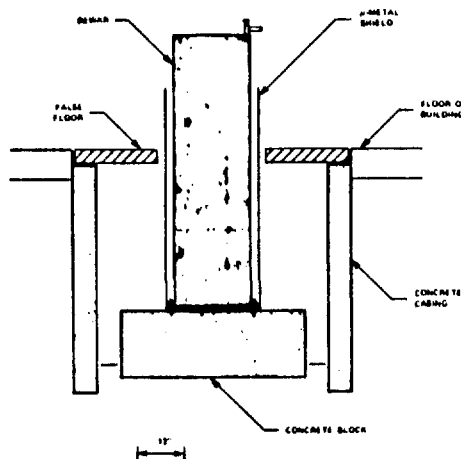

Figure 1. Magnetometer housing construction.



**UNCLASSIFIED**

Mr. Swann was shown the setup and told that if he were to affect the magnetic field in the magnetometer, it would show up as a change in the output recording. Then, to use his own description, he placed his attention on the interior of the magnetometer, at which time the frequency of the output doubled for about two of the cycles or roughly 30 seconds. This is indicated by A in Figure 2. Mr. Swann was next asked if he could stop the field change being indicated by the periodic output on the recorder. He then apparently proceeded to do just that, as can be seen at B in the graph, for a period of roughly 45 seconds. He then "let go," at which time the output returned to normal (C). Upon inquiry as to what he had done, he explained that he had direct vision of the apparatus inside and that the act of looking at different parts seemed to him to be correlated with the different effects. As he described what he was doing, the recording again traced out a double frequency cycle (shown at D), as had occurred before. An atypical dip (E) in the recording took place then, and on questioning him about what was happening, he said he was looking at a new part, the niobium ball sitting in a cup. This ball was inert at the time, not being used in the magnetometer experiment. He was asked to refrain

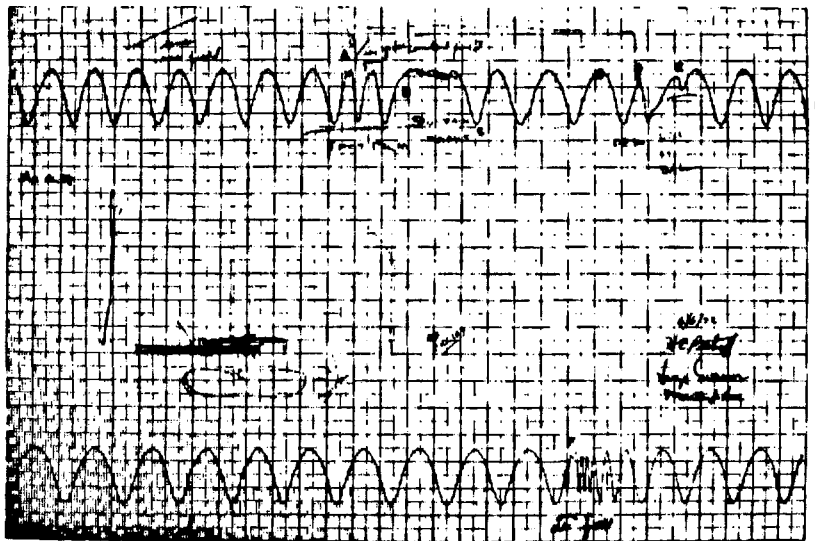

Figure 2. Raw data, magnetometer test run.

**UNCLASSIFIED**

from thinking about the apparatus, and the normal pattern was then traced out for several minutes (continued on lower trace) while he was engaged in conversation on other subjects. At one point he started to discuss the magnetometer again, at which point the tracing went into a high frequency pattern, shown at F. At our request he stopped, and the observation was terminated because Mr. Swann was tired from his effort. We then left the lab, while the apparatus was run for over an hour with no trace of noise or nonuniform activity, as indicated in Figure 3, where the top two traces show a continuing record following termination of the experiment. The third trace was taken some time later, the increase in the period indicating the reduced rate of magnetic field decay. At various times during this and the following day when similar data with Mr. Swann were taken, the experiment was observed by numerous other scientists.

The conditions of this observation, involving as it did a few hours use of an instrument committed to other research, of course prevented a proper investigation. The number of data samples was too few to permit meaningful statistical analysis, and the lack of readily available multiple recording equipment prevented investigation of possible "recorder only" effects.

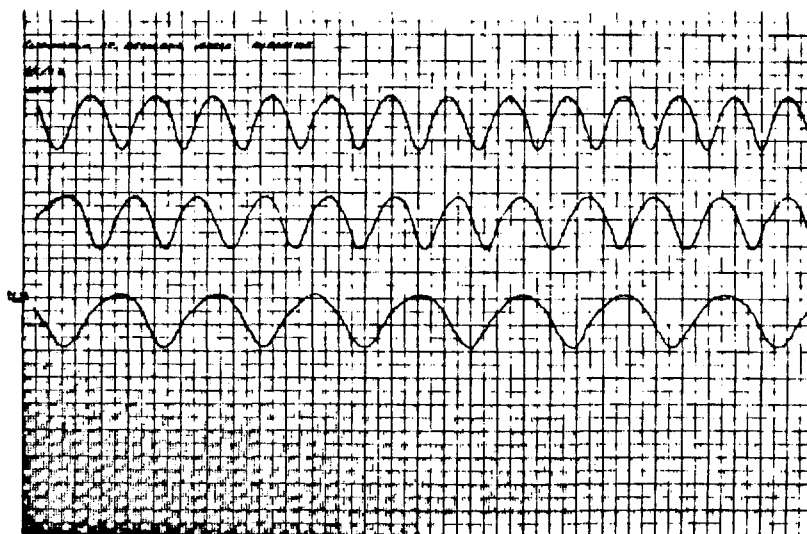

Figure 3. Raw data, magnetometer control run.

These observations fall into the general class of a laboratory anecdotal account<sup>1</sup> rather than a formal experiment.

The remaining sections in this report describe a general class of remote perturbation experiments involving effects observed in the output bit stream of binary random number generators.

C. Data Base for RNG Experiments

1. Early Experiments

In 1970, H. Schmidt reported<sup>2</sup> that he had observed significant perturbations, by psychoenergetic means, of an otherwise binary (0, 1) random sequence that was derived from the beta decay of strontium  $^{90}\text{Sr}$ . The binary sequence was produced by the random interruption of a high speed binary electronic clock when an electron from the  $^{90}\text{Sr}$  decay was detected. The sequence generation rate was approximately 1/s.

In this experiment individuals were asked to focus their attention on the electronic system by remote viewing the noise source, and monitoring any effects that occurred by watching the random walk of a display-light feedback system. (A circular array of lights was used to indicate the state of the interrupted clock by advancing the position of the activated light clockwise for each logical "1" and counterclockwise for each "0".)

When individuals focussed their attention on the apparatus the resulting binary (0, 1) sequence was found to contain only 49.1% 1s. Since the total sequence had a length of over 32,000 bits, the deficit of 1s was highly significant. The probability of such a result occurring by chance is less than one in a thousand. Furthermore, during extensive control runs when no individual was focusing his attention on the electronic hardware, the system performed according to the usual binomial statistic,

**UNCLASSIFIED**

and showed no statistical effect. Appendix A contains the original paper describing this experiment.

## 2. Total RNG Data Base

As of 1978, a total of 54 experiments of this type had been reported in the literature (see Table 1). Of these, 35 reported significant departure from chance expectation, and none reported similar effects during control runs. We can summarize the data base generated in these experiments as follows:

- The generation rate extended from a few per second to 300 per second.
- The sequence lengths varied from  $10^3$  to  $10^5$  bits.
- Beta decay and thermal noise were used as sources of randomness.
- The effects (deviation from 50% chance expectation) were on the order of 1% to 5%.
- Control runs did not yield results which differ significantly from chance expectation.

As an overall evaluation of the data base, it is unlikely that the apparent RP effect is simply an artifact of selected reporting by the laboratories involved; even if one were to assume that there were 10 unreported non-significant experiments for each reported significant one, the entire expanded data base would still show significant effects with odds against chance of better than 2000:1.

## 3. Critique of Data Base

There are, however, two characteristics of this data base which pose problems. First, the effects are rarely stable with one individual's RP effort, the quoted results being averages over a number of individuals. Secondly, the physical environment of the noise sources and associated

**UNCLASSIFIED**

**UNCLASSIFIED**

Table 1

## RANDOM NUMBER GENERATOR EXPERIMENTS--DATA BASE

Author (reference)	Comments	Level of Significance
Schmidt (3)	Preliminary experiment	n.s.
	Main experiment	0.00087
Schmidt (4)	1st cat series	0.016
	2nd cat series	n.s.
	1st roach series	0.0069
	2nd roach series	$1.2 \times 10^{-4}$
Schmidt & Pantas (5)	Preliminary experiment	0.012
	Series I	$6.3 \times 10^{-5}$
	Series II	0.0093
Matas & Pantas (6)		0.0014
Andre (7)	Experiment I	0.11
	Experiment II	0.009
Honorton & Barksdale (8)	Group series	0.034
	Individual Ss	n.s.
	Selected subject	$3.4 \times 10^{-6}$
Schmidt (9)	Exploratory experiment	$5.6 \times 10^{-6}$
	Confirmatory experiment	$2.1 \times 10^{-8}$
Bierman & Houtkeeper (10)		0.026
Schmidt (11)	Experiment I	
	Series 1	0.001
	Series 2	0.001
	Series 3	0.001
	Experiment II	
	Real-time	0.05
	Prerecorded	0.0005
	Experiment III	n.s.
Stanford & Fox (12)		0.05
Stanford, et al (13)		0.0069
Braud, et al (14)	Experiment I	0.002
	Experiment II	0.05
	Experiment III	n.s.

**UNCLASSIFIED**

**UNCLASSIFIED**

Table 1 (concluded)

Author (reference)	Comments	Level of Significance
Honorton & May (15)		0.035
May & Honorton (16)		0.011
Millar & Broughton (17)		n.s.
Millar & Mackenzie (18)		n.s.
Millar (19)		n.s.
Honorton & Winnett (20)	Meditator	0.018
Winnett & Honorton (21)	Meditators	0.0024
Braud & Hartgrove (22)	Meditators	0.034
Broughton, et al (23)		n.s.
Braud (24)	Experiment 1	0.028
	Experiment 2	0.022
	Experiment 3	n.s.
	Experiment 4	0.044
Schmidt (25)	Expt. I (prerecorded)	0.00037
	Expt. II (prerecorded)	n.s.
Terry & Schmidt (26)	Condition A	0.04
	Condition B	n.s.
Jungerman & Jungerman (27)	Experiment 1	n.s.
	Experiment 2	n.s.
Davis & Morrison (28)	Experiment 1	n.s.
	Experiment 2	n.s.
	New procedure	n.s.
Braud & Braud (29)	Experiment 1	n.s.
	Feedback	0.05
	No feedback	0.05
	Experiment 2 (no feedback)	0.05

electronics was not discussed in any detail for any of the experiments, so it is possible that some of the effects may be the result of normal and possibly subtle electronic interference.

**UNCLASSIFIED**

We intend to address these two problems by first focusing our attention upon a limited number (8 or less) of participants who have shown expertise as remote viewers in our earlier paranormal perception experiments.\* By using experienced remote viewers, it is anticipated that we should observe an effect within this limited number, rather than having to average over large numbers of individuals as in the data base experiments. Also, by using more sensitive analysis techniques than have been used previously, even a small effect can be stabilized.

Secondly, to assure ourselves that the noise sources are sufficiently free of even subtle (but normal) electronic nonrandomness, we intend to use the most rigorous construction and design techniques possible (battery power, optically coupled signals, etc.) to isolate the sources from normal environmental influences. Furthermore, the noise sources will be chosen for their internal simplicity<sup>30</sup> and thus may be amenable to realistic mathematical modelling. Using the models, we are able to calculate by Monte Carlo techniques a noise source's dependence on various external and internal physical parameters

D. Scientific Merits

If it is possible to have a stable remote perturbation source and detection system, no matter how small the effect, we would be able to investigate the nature of this interaction in a most straightforward manner. For example, distance effects could be accurately determined simply by doing experiments as a function of participant/device separation distance which in principal could range as far as interplanetary distances if necessary. Shielding and other effects could be investigated by placing

---

\* Described in Proc. IEEE, March 1976, included here as Appendix B.

**UNCLASSIFIED**

the detection system in various environments. Most importantly, we could investigate the relation (if any) between remote viewing and remote perturbation. Some relation might be expected since in ordinary physical interactions information about the state of a system can be obtained only by way of some interaction with the system, which in some cases is supplied by the observer. We might therefore expect an observable dependence between RV and RP under certain conditions.

E. Technical Application

Using the proper analysis procedure, even a very small effect can be made to operate a mentally-activated switch with arbitrarily high reliability.

**UNCLASSIFIED**



**UNCLASSIFIED**

## II EXPERIMENTS

A. General

We intend to replicate the type of experiments that are represented by the data base discussed in the previous section. These experiments are to be carried out however, under conditions more rigorously controlled. As with the earlier experiments, our proposed experiments contain three basic elements:

- (1) Noise sources-- $\beta$  decay, noise diode.
- (2) Analysis and recording techniques--LSI-11, floppy-disk-based microcomputer.
- (3) Feedback display--video system.

In this section we describe the assumptions and the independent and dependent variables that are implied in such an experiment. This section also contains an outline of the hardware and software components of the complete random number generator system.

B. Assumptions

The characteristics of this hypothesized remote perturbation process are completely unknown. The data base suggests that the putative effect is quite small, so it is reasonable to make a few assumptions about our experiments: (1) the analysis hardware (LSI-11 microcomputer), the recording device (floppy disk system), and the display devices (computer-driven video monitors) are to first order assumed to be stable against remote perturbation processes, the effect being assumed to be isolated within the random noise sources exclusively (an assumption that can be checked during the course of experimentation); (2) the source of the remote

**UNCLASSIFIED**

perturbation is assumed to be the human participant. Evidence to date tends to support these assumptions.

C. Independent Variables

There are three primary independent variables that may be varied during the course of the investigation:

- (1) Participant/no participant.
- (2) Source variation (beta decay, noise diode, pseudo random).
- (3) Feedback display variation.

D. Dependent Variables

There is only one dependent variable, namely the output of the statistical analysis of the binary bit stream derived from the noise source.

E. Hardware

An electronic instrument that is designed to be sensitive to remote perturbation processes contains three basic elements: sources of randomness, an analysis capability, and a feedback mechanism. We propose to integrate these components with our existing Digital Equipment Corporation LSI-11/2 microcomputer system. Figure 4 shows a block diagram for such a system.

1. Random Sources

We will consider three types of random sources: an electronic noise diode, a radioactive (beta) decay source, and a pseudo-random feedback shift register.

**UNCLASSIFIED**

FIGURE 4 BLOCK DIAGRAM OF A COMPUTER-BASED INSTRUMENT DESIGNED TO BE SENSITIVE TO REMOTE PERTURBATION PROCESSES

a. Electronic Noise Diode

In a preliminary design effort carried out in another program, we have selected a suitable electronic noise diode. The diode, first constructed by Haitz,<sup>30</sup> is well understood from the quantum mechanical point of view.

b. Radioactive Beta Decay Source

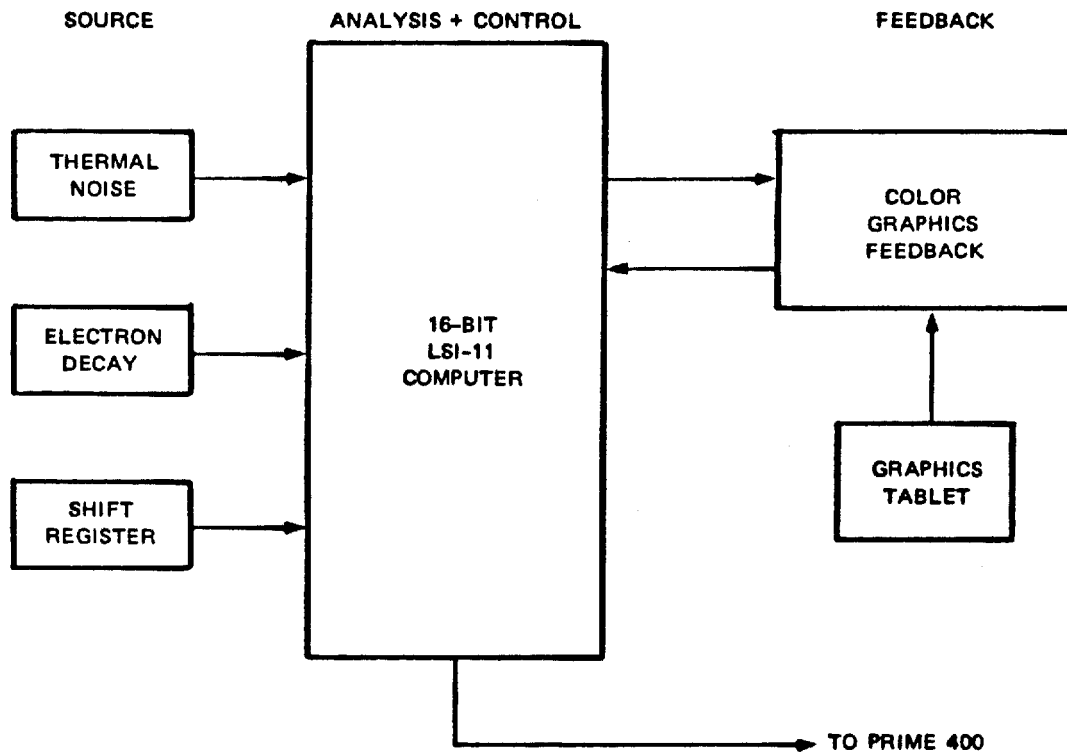
We propose to design a binary noise source derived from the beta decay of carbon 14 ( $^{14}\text{C}$ ) and promethium 147 ( $^{147}\text{Pr}$ ). We have chosen these isotopes since they are 100% beta emitters with no competing decay modes, and thus provide a simple radioactive decay spectrum. To insure isolation from spurious power line transients we plan to use battery-operated

**UNCLASSIFIED**

**UNCLASSIFIED**

surface barrier detector with charge-sensitive preamplifier and associated shaping circuitry to produce the random binary noise signal. This and the electronic noise source will be optically coupled to the LSI-11.

c. Pseudo-Random Shift Register

To act as a control noise source we will optically couple a standard pseudo-random shift register to the LSI-11. The binary output of such a device has the property that although the sequence meets a number of criteria for randomness, the sequence is deterministic, once the starting seed for the register is given.

2. Analysis

The analysis and control portion of the system consists of an existing project LSI-11 microcomputer. To obtain an input, the LSI-11 is programmed to sample one of the noise sources at a specified rate to obtain its random bits. A sequence of such samples is tested by the LSI-11 for an excess or deficiency of 1s on a continuous basis, using a sequential analysis statistical technique.<sup>31,32</sup> The sequential analysis technique is an extremely efficient technique for determining whether the output of the binary random generator contains a distribution of 0s and 1s as expected for an unperturbed source, or is distorted due to, say, RP influence. The principal advantage of the sequential sampling technique as compared with other methods is that, on average, fewer bits per final decision are required (roughly 50%) for an equivalent degree of reliability.

Before we are able to detect that the random output of the binary generator has been distorted, we must a priori define how much distortion we require to conclude that there is an effect, and what statistical risks we are willing to accept for making an incorrect decision as to whether the distribution under consideration is indeed distorted.

**UNCLASSIFIED**

**UNCLASSIFIED**

To meet these criteria sequential analysis requires the specification of four parameters to determine from which of two binomial distributions under consideration (distorted or undistorted) a data sample belongs. The four parameters are:  $p_0$ , the fraction of 1s expected in an undistorted distribution (e.g., 50%);  $p_1$ , the fraction of 1s assigned a priori to define a distorted distribution (e.g., 60%);  $\alpha$ , the a priori assigned acceptable probability for concluding that the random source is perturbed ( $p_1$  distribution) when in fact it is not perturbed, i.e., the correct distribution is the  $p_0$  one (Type I error);  $\beta$ , the a priori assigned acceptable probability for concluding that the random source is unperturbed ( $p_0$  distribution) when in fact it is perturbed ( $p_1$  distribution), i.e., the correct distribution is the  $p_1$  one (Type II error). With the parameters thus specified, the sequential sampling procedure provides for construction of a decision graph as shown in Figure 5. The decision graph gives a rule of procedure for making one of three possible decisions following the sampling of each bit: continue sampling before making a decision (Region I in Figure 5); label the sequence as undistorted (Region II); label the sequence as distorted (Region III).

Sampling rules can be defined for the nth sample:

- (1) Sample the binary sequence
- (2) Sum the numbers of 1s to date
- (3) If the sum of 1s lies in Region I then do Step (1).
- (4) If the sum lies in Region II, stop the run, concluding that the binary sequence is derived from the undistorted  $p_0$  distribution.
- (5) If the sum lies in Region III, stop the run, concluding that the binary sequence is derived from the distorted  $p_1$  distribution.

Utilization of the above statistical procedure permits analysis of the binary noise sequence for excess 1s or 0s by the most efficient technique currently possible.

**UNCLASSIFIED**

UNCLASSIFIED

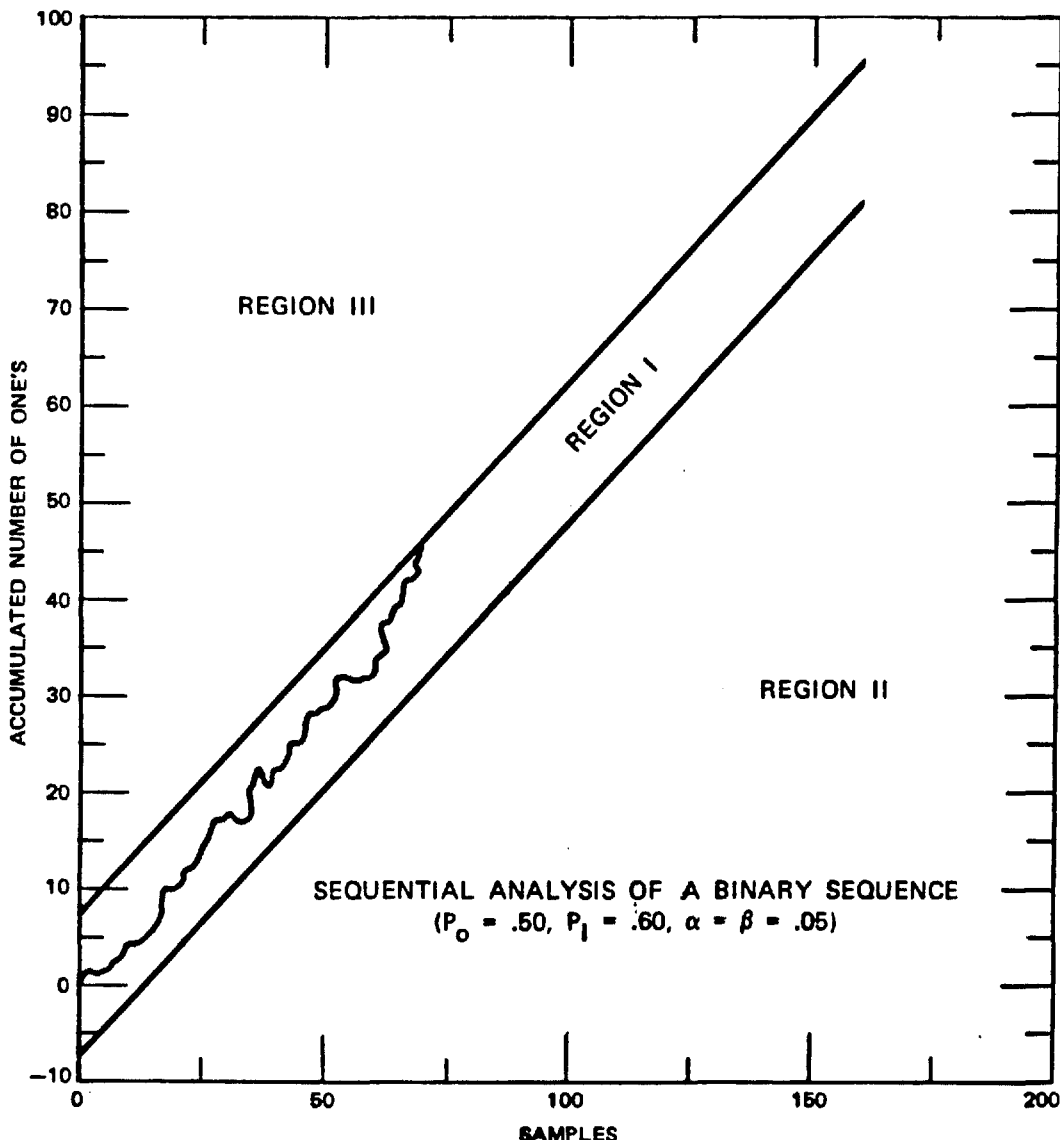

FIGURE 5 IF THE ACCUMULATED NUMBER OF 1s ENTERS REGION III, THE SEQUENCE IS ACCEPTED AS PERTURBED. If it enters Region II, the sequence is accepted as unperturbed, and no decision is made while the accumulated number of 1s remains in Region I.

UNCLASSIFIED

**UNCLASSIFIED**

### 3. Display

The feedback display to the participant consists of two independent color video channels. The output from the computer analysis of the binary bit stream will "drive" some interesting aspect of the video image. The second channel may be connected to a video recorder for later off-line analysis.

### 4. Hardware Redundancy

Using a computer system such as the one described above as a possible detector of remote perturbation, it is important to have as much hardware redundancy as possible. Particularly in the areas of data recording and feedback display. As was stated above, the most likely assumptions for experiments of this type are that the recording and display hardware are stable with respect to remote perturbation processes. It is possible to examine partially the validity of these assumptions with suitable hardware redundancy. We plan to record the raw noise data prior to analysis, and to record the feedback display on video tape during the experiment, using the second channel of the display facility. After the participant has left the area, a comparison can be made between the actual display during the experiment and the display which is now generated from the recorded raw data of the experiment. If there is a disagreement, we are able to isolate the perturbation to the analysis display (as opposed to source) hardware. An agreement between the two displays is an indication that the initial assumptions are valid.

**UNCLASSIFIED**

**UNCLASSIFIED**

III PARTICIPANTS

A. Selection Criteria

SRI International has individuals who are presently participating in remote viewing experiments. Some of these are consultants, others are members of the SRI staff. Only those individuals who indicate a positive desire to participate, after familiarization with the remote perturbation experiments and procedures, will be accepted into the RP program. An information and consent form is included below (Section E).

In addition to willingness to participate, special attention will be paid to enlisting the support and participation of those subjects who have already demonstrated ability in the area of remote viewing.

B. Payment Criteria

The participants will be paid monthly in accordance with the number of sessions contributed, and the payment is independent of their performance in the sessions.

C. Experiment Duration

The total duration of the investigation is 6 months. Experiment sessions will take place during the normal work week and will not exceed 1/2 hour length each. There will be no more than 2 sessions per day, one in the morning and one in the afternoon.

D. Number of Participants

We plan to ask our experienced remote viewers to participate in this investigation, and we expect to work with no more than eight individuals. All participants are to be in general good health, as determined by a standard SRI employment physical examination.

**UNCLASSIFIED**



**UNCLASSIFIED**

E.

VOLUNTEER CONSENT FORM

I, \_\_\_\_\_, SSN \_\_\_\_\_, having attained my eighteenth (18th) birthday, and otherwise having full capacity to consent, do hereby volunteer to participate in this program to determine the nature, and possible applications of inherent psychic abilities. The following items have been explained to me by \_\_\_\_\_, and are set forth on the reverse side of this agreement, which I have initialed.

a. The nature, duration, purposes, and expected benefits of the program in which I will be participating.

b. The methods and means by which the program is to be conducted; any methods and means that are experimental will be identified as such.

c. The inconveniences, hazards, discomforts, risks or other effects on my health or person which may possibly come from my participation in the program.

d. The alternative procedures, if any, that might be employed to protect or further my health and well-being. I have been given an opportunity to ask questions concerning this project and any such questions have been answered to my full and complete satisfaction. I understand that I may at any time during the course of this project revoke my consent and withdraw from the study without prejudice; however, I may be requested to undergo certain further examinations, if, in the opinion of a qualified physician, such examinations are necessary for my health or well-being.

\_\_\_\_\_  
(Name) (Date)

I was present during the explanation referred to above, as well as the volunteer's opportunity for questions, and hereby witness his signature. I am not involved in the program in any way.

\_\_\_\_\_  
(Name) (Date)

**UNCLASSIFIED**

**UNCLASSIFIED**

1. Explanation of the Experiments. The purpose of these experiments is to determine the extent to which a person is able to mentally perturb or affect sensitive electronic equipment. In this case a random number generator will control a variety of different video displays generated by a small computer. Your interaction with the computer is to be by mental means alone. You will be asked to try to make changes in the video display; or, in biofeedback terminology, to use passive volition to produce the desired change. We are naming this interaction between a person and a remote system remote perturbation, or RP for short. We are endeavoring to both foster and understand these abilities.

In the course of these experiments, no drugs, hypnosis, psychopharmacological agents of any kind or subliminal stimulation will be used.

2. Explanation of the Procedures. You will be asked to sit in a comfortably appointed environment at SRI building 44 (see Figure 6). A video display will be present which you may attend to if you wish. In the course of a half-hour session, a number of electronically controlled runs will be carried out, in which you will be asked to try to cause a change on the video monitor, by an act of will. You will receive immediate feedback, if you wish, to assist you in gaining conscious control over the remote perturbation abilities we are examining. You will be asked to participate in no more than one half-hour session in the morning, and one half-hour session in the afternoon. At any time you may decline to take part in either session, without prejudice to your continued participation in the program.

3. Description of Reasonably-Expected Inconveniences, Hazards, Discomfort, Risks, or Other Effects. There is no known evidence for any adverse effects or risks associated with participation in research of this type. Investigations such as these have been carried out in laboratories for almost a hundred years in the United States and England, and there is no record of any type of hazard or discomfort to a participating subject.

4. Description of Any Alternative Procedure that Might be Employed to Protect the Subject's Health. There is no known risk to protect against.

5. Description of Alternative Advantages to the Volunteer. He has opportunity to gain conscious control over otherwise latent or unconscious processes within himself.

6. Questions Posed by Volunteer--and Answers. (To be filled in.)

Volunteer will initial end of each of the above paragraphs.

**UNCLASSIFIED**

F. Medical Facilities

1. Personal Injuries

General. When accidents occur involving personal injuries to staff members or subjects, the supervisor shall:

- (1) Ensure that the staff member or subject receives first aid and medical care immediately.
- (2) In the event the accident is serious enough to warrant additional assistance, Dial 7.
- (3) Investigate the accident and prepare in duplicate a Supervisor's Accident Investigation Report. This report must be submitted to the Area Director or his designee the same day. The Area director will sign the report and forward the original to the Health & Safety Office via designated Area channels.

Medical Assistance in Case of Injury. The Menlo Medical Clinic, 1111 University Drive, Menlo Park, has been designated to handle industrial accident cases from the Institute. Office hours at the clinic are:

Monday through Friday	9:00 a.m. - 5:30 p.m.
Saturday	9:00 a.m. - 12:30 p.m.

At hours other than the above, the Emergency Section of the Palo Alto/Stanford Hospital, 300 Pasteur Drive, Palo Alto, handles our industrial cases.

2. Emergency Response Program

The Health & Safety Director, or his designated alternate, is responsible for the preparation of the Institute Emergency Program and the coordination of all emergency activities. He has complete authority to take whatever action is necessary to protect human life or property in the time of an emergency.

Procedure. In the event of an emergency, the person involved should as soon as practical:

## DIAL 7

Inform the operator of the emergency and request professional assistance--  
Fire Department, ambulance, hospital, doctor, etc.

- (1) Upon receiving the emergency call, the operator will connect the person with the Institute's Emergency Response Team. They shall ascertain the location of the emergency, the condition of the injured person (is he physically able to travel to the clinic in a personal automobile or should he be transported to the hospital by ambulance), the type of emergency--fire, explosion, radioactive spill, etc.
- (2) The operator who is monitoring the conversation will then call the applicable professional service as directed:
- (3) If the injured is ambulatory, the operator will call the Medical Clinic. If the injured requires an ambulance, she will call the ambulance company, alert the clinic to send a doctor to the hospital, and alert the hospital that the patient is being transported by ambulance to the hospital.
- (4) While waiting for assistance and . . .
  - (a) if the injured person is bleeding profusely, the first aider should try to stop the flow of blood. He should apply direct pressure over the wound, thus arresting the flow of blood.
  - (b) if the injured person is not breathing, the first aider should apply mouth-to-mouth resuscitation or whatever method he is most familiar with, in order to revive the injured person as soon as possible.
  - (c) if the injured person is suffering from shock, wrap or cover the injured person with a blanket. (A blanket is available in the lounge of the women's restrooms.)

UNCLASSIFIED

The Emergency Response Team is comprised of members from five departments within the Institute. These departments are Health & Safety, Security, Personnel, Public Relations, and Maintenance. This team is comprised of specialists selected to cope with minor emergencies. In the event a major emergency arises, the Emergency Response Team will be augmented by a larger organization of staff members who have volunteered their services because of their special skills.

Special Emergency instructions (e.g., evacuation routes, fire alarm information, etc.) are posted on each area's bulletin boards. Detailed information concerning the entire program is contained in the Emergency Response Program booklet available to all team members from the Health & Safety office.

3. Insurance Coverage

Medical and Disability Benefits. Participants in the Remote Participation activities will fall into three classes, with resulting differences in their insurance coverage.

SRI Employees (California). Their participation in the project will be as part of their employment at SRI. Therefore, if they sustain any injury or illness as a result of their participation in the project, they would be entitled to the benefits of Worker's Compensation Insurance, as prescribed by the State of California. These benefits include full medical treatment, reimbursement for lost wages (subject to statutory limitations), and awards for permanent disability, if any.

U.S. Government Employees. Presumably their participation would be in the course of their employment with the U.S. Government, and so they would be entitled to the federal equivalent of Worker's Compensation Insurance benefits.

Individual Consultants. As independent contractors, consultants would not be covered by Worker's Compensation Insurance, nor would they be covered by any of the insurance benefits available to SRI employees or government employees. They would have to look to their own personal insurance for protection.

UNCLASSIFIED

**UNCLASSIFIED**

If a consultant or a government employee were injured while on SRI's premises and it could be established that the injury was the result of negligence on the part of SRI, i.e., defective tread on a stair, then SRI would be liable to the injured party for his or her resulting damages. SRI has substantial public liability insurance which covers this type of claim.

G. Debriefing Schedule

1. Session Debriefing

At the end of each experimental session, the subject will be given all the data available pertaining to that group of trials. Any statistical significance or lack thereof will also be clearly explained to him.

2. Experiment Debriefing

At the conclusion of experimental testing, a final unclassified report will be prepared, summarizing all results from the experiment, together with any conclusions or scientific findings that may have come out of the study. The report will be given to each participating subject. Finally, any remaining questions that the subjects may have about the experiment will be answered.

3. Specific Debriefing Protocols

We do not anticipate that participation in these experiments will have any effect on the day-to-day life of the subjects. This study is a purely intellectual activity, and we believe that the debriefing provided by the final technical report will be a suitable termination of the experiment for the subject.

**UNCLASSIFIED**

**UNCLASSIFIED**

## IV INVESTIGATION ANALYSIS CRITERIA

The first 4 months of the investigation will be used as a pilot period during which the participants will familiarize themselves with the experiment and explore various techniques in a learning mode. This period will also be used to optimize the device parameters. During the final two months of the investigation, each participant will be asked to contribute 100 runs. Using the analysis described above, we will determine the number of runs that had odds against chance expectation of greater than 20:1. If this total number of runs is greater than 10 (the number required by exact binomial calculation to meet odds against chance of greater than 20:1) then we will declare that participant to have a significant result. To assess whether the entire investigation is significant, we shall combine the results of the eight participants using standard statistical procedures.<sup>33</sup>

**UNCLASSIFIED**

**UNCLASSIFIED**

V ENVIRONMENT

The laboratory in which these experiments will be conducted is located on the third floor of the Radio Physics Building (Bldg. 44) in the SRI International complex at Menlo Park, California.

The room to be used for this work is a comfortable, carpeted, air-conditioned environment. It is lit by a combination of fluorescent and incandescent fixtures in the ceiling. There is a couch, an easy chair, and two tables. The computer graphics terminal stands on one of these tables. The participant will be seated on a conventional reclining swivel chair.



**UNCLASSIFIED**



**UNCLASSIFIED**

## REFERENCES

1. H. E. Puthoff and R. Targ, "Physics, Entropy, and Psychokinesis," Proc. 23rd Annual International Conference, Quantum Physics and Parapsychology, Geneva, Switzerland (August 1974).
2. H. Schmidt, "A PK Test with Electronic Equipment," J. Parapsychology, Vol. 34, No. 3, pp. 175-181 (September 1970).
3. H. Schmidt, J. Parapsychology, Vol. 34, p 175 (1970).
4. H. Schmidt, J. Parapsychology, Vol. 34, p. 255 (1970).
5. H. Schmidt and L. Pantas, J. Parapsychology, Vol. 36, p. 222 (1972).
6. F. Matas and L. Pantas, Proc. Parapsychol. Assn., Vol. 8, p. 12 (1971).
7. E. Andre, J. Parapsychology, Vol. 36, p. 283 (1972).
8. C. Honorton and W. Barksdale, J. Amer. Soc. Psychical Research, Vol. 66, p. 208 (1972).
9. H. Schmidt, J. Parapsychology, Vol. 37, p. 105 (1973).
10. D. J. Bierman and J. M. Houtkeeper, European J. Parapsychology, Vol. 1, p. 3 (1975).
11. H. Schmidt, J. Amer. Soc. Psychical Research, Vol. 70, p. 267 (1976).
12. R. G. Stanford and C. Fox, Research in Parapsychology 1974, p. 61.
13. R. G. Stanford, R. Zenhausern, A. Taylor, and M. Dwyer, J. Amer. Soc. Psychical Research, Vol. 69, p. 127 (1975).
14. W. G. Braud, G. Smith, K. Andrew, and S. Willis, Research in Parapsychology 1975, p. 85.
15. C. Honorton and E. C. May, Research in Parapsychology 1975, p. 90.
16. E. C. May and C. Honorton, Research in Parapsychology 1975, p. 88.

**UNCLASSIFIED**

**UNCLASSIFIED**

17. B. Millar and R. Broughton, Research in Parapsychology 1975, p. 83.
18. B. Millar and J. Mackenzie, Research in Parapsychology 1976, p. 23.
19. B. Millar, Parapsychology Assoc. Meeting 1977.
20. C. Honorton and R. Winnett, Research in Parapsychology 1976, p. 97.
21. R. Winnett and C. Honorton, Research in Parapsychology 1976, p. 95.
22. W. G. Braud and J. Hartgrove, Parapsychology Assoc. Meeting 1977.
23. R. Broughton, et al, Research in Parapsychology 1977, p. 41.
24. W. G. Braud, Parapsychology Assoc. Meeting 1976.
25. H. Schmidt, Research in Parapsychology 1977.
26. J. Terry and H. Schmidt, Research in Parapsychology 1977, p. 36.
27. J. Jungerman and R. Jungerman, Research in Parapsychology 1977, p. 157.
28. J. Davis and R. Morrison, Research in Parapsychology 1977, p. 163.
29. L. W. Braud and W. G. Braud, Research in Parapsychology 1977, p. 135.
30. R. H. Haitz, "Controlled Noise Generation with Avalanche Diodes," IEEE Transactions on Electron Devices, Vol. ED-13, No. 3, pp. 342-346 (March 1966).
31. A. Wald, Sequential Analysis, Dover Publications, Inc., New York (1973).
32. M. Fisz, Probability Theory and Mathematical Statistics, John Wiley & Sons, Inc., pp. 584-611, New York (1973).
33. R. Rosenthal, "Combining Results of Independent Studies," Psychological Bulletin, 1978, Vol. 85, No. 1, pp. 185-193.

**UNCLASSIFIED**

**UNCLASSIFIED**

Appendix A

A PK TEST WITH ELECTRONIC EQUIPMENT

by H. Schmidt

**UNCLASSIFIED**

UNCLASSIFIED

The Journal of  
**Parapsychology**

VOLUME 34

SEPTEMBER 1970

NUMBER 3

## A PK TEST WITH ELECTRONIC EQUIPMENT

By HELMUT SCHMIDT

CPYRGHT

**ABSTRACT:** The subjects in this research were tested for their psychokinetic ability by means of an electronic apparatus made up of a random number generator (RNG) connected with a display panel. The RNG produced random sequences of two numbers which were determined by a simple quantum process (the decay of radioactive strontium-90 nuclei). The essential aspect of the display panel was a circle of nine lamps which lighted one at a time in the clockwise (+1) direction or the counterclockwise (-1) direction depending on which of the two numbers the RNG produced. The subject's task was to choose either the clockwise or counterclockwise motion and try by PK to make the light proceed in that direction.

One run was made up of 128 "jumps" of the light, and there were four runs per session. In a preliminary series of 216 runs, the 18 subjects had a negative deviation of 129 hits. Accordingly, the main series was expected to give negative scores, and a negative attitude was encouraged among the subjects. Fifteen subjects carried out 256 runs, with a significant negative deviation of 302 hits ( $P = .001$ ).

The RNG was checked for randomness throughout the experiment and was found to be adequate.—Ed.

In previous work (4, 5) the author was able to get significant evidence of precognition in which the testing apparatus was an electronic device based on a simple quantum process. The present experiment was an attempt to get significant evidence of psychokinesis by the use of a similar apparatus.

The basic part of the apparatus was a binary random number generator which produced the numbers "+1" and "-1" in random sequence, and the general objective was to have the subjects try to mentally influence the generator to produce one of the two numbers more frequently than the other.

UNCLASSIFIED

**UNCLASSIFIED**CPYRGHT  
176*The Journal of Parapsychology*

The most easily available random generators, which have been used in many PK experiments, are a rolled die and a flipped coin. In comparison with these, an electronic random generator, the operation of which most of the subjects cannot understand, may at first thought seem psychologically unfavorable. Results of experiments with complex targets (3, p. 142), however, suggest that PK is goal oriented in the sense that results can be obtained by concentrating on the goal only, no matter how complicated the intermediate steps may seem to the rationalizing mind. A definite advantage of an electronic apparatus is that it permits a psychologically challenging formulation of the goal. In the present experiment the random number generator (RNG) was connected with a display panel showing a circle of nine lamps. One lamp was lit at a time, and each generated "+1" or "-1" caused the light to jump one step in the clockwise or counterclockwise direction, respectively. The subjects were not asked to try to force the generator to produce more +1's than -1's but, rather, to force the light on the panel to make more jumps in one direction or the other. Both tasks are certainly equivalent, but the latter seems psychologically much more appealing to most subjects.

A further obvious advantage of electronic test equipment is that the detailed results can be automatically recorded and evaluated and that one can work, if desired, at high speeds.

The particular type of random generator used here was chosen partly for practical and partly for theoretical reasons. The sequence in which the random numbers are produced is determined by simple quantum processes, the decays of radioactive strontium-90 nuclei. The electrons emitted in this decay trigger a Geiger counter, and the random times at which electrons are registered at the Geiger counter decide the generated numbers. Practically, the generator is easy to build, and the randomness of the generated numbers has been found to be very good. Furthermore, the simplicity of the generator allows a complete theoretical discussion (6) of its randomness properties; and in addition, one can say fairly well at which point the random element in the number generation comes in. The generator is essentially deterministic except for the random decay times of the nuclei.

The use of simple quantum jumps to provide randomness is, for

**UNCLASSIFIED**

**UNCLASSIFIED***A PK Test with Electronic Equipment*

177

CPYRGHT

the theorist, a rather natural choice, since these processes are assumed by physicists to be nature's most elementary source of randomness, and some psi tests utilizing quantum processes have already been reported (1, 2). Certainly, the outcome of a die throw is also largely determined by microscopic quantum processes. The thermal vibrations of the surface and the air fluctuations at an atomic level co-determine the generated die face. The process in this case is much more complicated, however, since many more factors contribute to the end result.

**APPARATUS**

The test equipment consisted of a binary random number generator and a display panel.

*Random Number Generator*

The RNG, which was similar to the one described in connection with earlier precognition experiments (4, 5, 6), can produce sequences of binary random numbers of any specified length. Electrons emitted by the strontium-90 decay trigger a Geiger counter and the momentary position of a binary high frequency counter at the time of the electron registration determines whether a "+1" or a "-1" is generated.

The numbers of electrical pulses produced on the +1 output and the -1 output are recorded by two electromechanical reset counters, and the complete sequence of generated numbers is recorded on paper punch tape.

*Randomness Tests*

Because of the simplicity of the circuitry, the degree of randomness to be expected of the RNG can be discussed in detail (6) and it can be shown to be much greater than required by the experiment.

The electronic circuitry is designed so that variations in the characteristics of the components cannot impair the randomness. In order to guard against any gross malfunctions, the proper electronic operation was tested frequently. Furthermore, the randomness of the generated number sequence was tested experimentally. For this purpose, a sequence of four million numbers, generated on many

**UNCLASSIFIED**

**UNCLASSIFIED**

178

*The Journal of Parapsychology*

CPYRGHT

different days, was recorded on paper tape. Then for the whole sequence the numbers  $N^+$ ,  $N^-$  of generated +1's and -1's were counted and were found to be consistent with randomness, as was the total number of flips (F); i.e., events where a +1 was followed by a -1 or vice versa. The same procedure was applied to the 400 number sequences obtained by cutting the whole sequence into blocks of 10,000 numbers each. A goodness-of-fit test verified that the 400 values for +1 and -1, and the 400 values for F were consistent with their expected normal distribution.

*Display Panel*

In testing with this apparatus, the two above-mentioned counters for the numbers of generated +1's and -1's could serve as the only display, i.e., the (visual) focusing point toward which the subject could have directed his PK efforts. In this case, the subject might try to enforce mentally on the +1 counter a higher number of counts than on the -1 counter. It seemed desirable, however, to use a psychologically more stimulating display in the form of a panel with nine lamps arranged in a circle and connected to the RNG by a 30-foot long cable. One of the nine lamps was lighted at a time; and each time the RNG produced a signal, the light advanced one step in the clockwise or the counterclockwise direction according to whether the signal came to the +1 or the -1 output. Thus the light performed a "random walk" among the nine lamps. Rather than direct his PK toward the counters, then, the subject generally tried to "will" the light on the display panel to advance in an overall clockwise motion.

Some of the subjects, however, preferred to force the light in the counterclockwise direction. For them the two signal wires from the RNG to the display panel were interchanged by flipping a switch on the display panel so that a count on the +1 counter was displayed as a jump of the light in the counterclockwise direction. Thus, for all subjects, a jump of the lamp in the preferred direction, whether clockwise or counterclockwise, was registered on the +1 counter.

**TEST PROCEDURE**

The subjects in this experiment were members of the Institute for Parapsychology plus a few visitors. During a test session, the

**UNCLASSIFIED**

**UNCLASSIFIED***A PK Test with Electronic Equipment*

179

subject sat in a dark closet with the display panel in front of him. The RNG and the experimenter were stationed in the room outside the closet.

Each testing session comprised 4 runs of 128 counts (steps in the random walk). A run took approximately two minutes. The machine stopped automatically after the one hundred and twenty-eighth count. There were short breaks, mostly between one-half and two minutes, between the runs.

At the beginning of each run, the subject, having decided in which direction (clockwise or counterclockwise) he wanted to influence the light to go, set a switch on the panel accordingly. Then the experimenter turned on the start switch, causing the RNG to generate 128 random numbers. At the end of each run, the experimenter recorded the readings of the +1 counter and -1 counter. The correctness of the counter readings was later checked with the sequence of generated numbers recorded on the paper punch tape.

From the experimenter's point of view, the subject's goal was always to produce a high number of +1 counts. From the subject's viewpoint the equivalent goal was to influence the light in the direction desired and indicated by the position of the switch on the display panel.

The subject was permitted to flip the switch during the course of a run so as to change the direction in which he wanted the hits displayed, but only a few subjects actually took advantage of the opportunity. With this arrangement, the subject could have had the impression that he was doing a test in precognition (by setting the switch in the direction in which he thought the light would move on the next jump) while he was actually doing a PK test.

**PRELIMINARY SERIES**

There were 18 subjects in the preliminary series and they carried out a total of 54 sessions, each subject contributing from one to seven sessions.

The total score was a negative deviation of 129 hits below chance expectation out of 216 runs;  $CR = 1.55$ . These results include one subject who obtained a high positive score of 52 hits above chance in 16 runs ( $CR = 2.3$ ).

**UNCLASSIFIED**

CPYRGHT



UNCLASSIFIED

## MAIN SERIES

It was expected on the basis of the preliminary results that by leaving out the one high-scoring subject, an overall significantly negative score would be obtained in the main series. In order to emphasize the negative scoring, some subjects were asked to associate feelings of pessimism and failure with the experiment. The more negative-scoring subjects were used more frequently, and a few new subjects were allowed to contribute only after preliminary tests had suggested a negative scoring tendency.

The total length of the experiment was set in advance at 64 sessions of four runs each. It was not determined in advance, however, how many sessions each individual subject should contribute. Altogether there were 15 subjects and they contributed between one and 10 sessions each.

Although the proper randomness of the generator had been tested extensively, as mentioned before, a further safeguard against a possible bias of the generator was introduced. After the first half of the confirmatory test was completed the two outputs of the generator were internally interchanged. Thus, even a constant bias in the generator could not have caused the total significant score to be reported.

A total of 256 runs in this part of the experiment yielded a negative deviation of 302 hits ( $CR = 3.33$ ;  $P < .001$ , two-tailed). Of the 64 sessions, 46 gave below-chance scores, 15 above-chance scores, and three were just at chance level ( $CR = 4.0$ ). Of the 256 runs, 147 were below chance, 92 above chance, and 17 at chance level ( $CR = 3.55$ ). These three  $CR$  values are certainly not independent, but they do emphasize the consistency of the results.

A post hoc analysis of the data showed two types of decline effect: more negative scoring in the second half of each run than in the first; and more negative scoring in the second half (the third and fourth runs) of each session than in the first half (first two runs). The decline results, however, are suggestive rather than statistically significant:

Deviation for pooled first half of the run: -91

Deviation for pooled second half of the run: -211

Deviation for the pooled first half of the session: -83

Deviation for the pooled second half of the session: -219

CPYRGHT

UNCLASSIFIED

UNCLASSIFIED

*A PK Test with Electronic Equipment*

181

CPYRGHT

## DISCUSSION

The result of the experiment shows that the binary random number generator had no bias for generation of +1's or -1's as long as it was left unattended (in the randomness tests) but that it displayed a significant bias when the test subjects concentrated on the display panel, wishing for an increased generation rate of one number.

The experiment has been discussed in terms of PK, but in principle the result could certainly also be ascribed to precognition on the part of the experimenter or the subject. Since the sequence of generated numbers depended critically on the time when the test run began, and since the experimenter, in consensus with the subject, decided when to flip the start switch, precognition might have prompted experimenter and subject to start the run at a time which favored scoring in a certain direction.

If the PK interpretation is appropriate, the results imply the action of PK at some distance, since the generator was separated from the subject by a wall and only the display panel was close to the subject.

## REFERENCES

1. BELOFF, J., and EVANS, L. A radioactivity test of psychokinesis. *J. Soc. psych. Res.*, 1961, 41, 41-46.
2. CHAUVIN, R., and GENTHON, J. Eine Untersuchung über die Möglichkeit psychokinetischer Experimente mit Uranium und Geigerzähler [An investigation of the possibility of PK experiments with uranium and a Geiger counter]. *Zeitschrift für Parapsychologie und Grenzgebiete der Psychologie*, 1965, 8, 140-47.
3. RHINE, L. E. *Mind Over Matter*. New York: Macmillan, 1970.
4. SCHMIDT, H. Anomalous prediction of quantum processes by some human subjects. Document D1-82-0821 (1969). Boeing Scientific Research Laboratories, Seattle, Washington. Available from Clearing House, U.S. Dept. Commerce, Springfield, Va.
5. SCHMIDT, H. Precognition of a quantum process. *J. Parapsychol.*, 1969, 33, 99-108.
6. SCHMIDT, H. Quantum-mechanical random-number generator. *J. app. Physics*, 1970, 41 (No. 2), 462-68.

*Institute for Parapsychology  
College Station  
Durham, N. C. 27708*

UNCLASSIFIED

**UNCLASSIFIED**

Appendix B

A PERCEPTUAL CHANNEL FOR INFORMATION TRANSFER  
OVER KILOMETER DISTANCES: HISTORICAL PERSPECTIVE  
AND RECENT RESEARCH

**UNCLASSIFIED**

# A Perceptual Channel for Information Transfer over Kilometer Distances: Historical Perspective and Recent Research

HAROLD E. PUTHOFF, MEMBER, IEEE, AND RUSSELL TARG, SENIOR MEMBER, IEEE

CPYRGHT

**Abstract**—For more than 100 years, scientists have attempted to determine the truth or falsity of claims for the existence of a perceptual channel whereby certain individuals are able to perceive and describe remote data not presented to any known sense. This paper presents an outline of the history of scientific inquiry into such so-called paranormal perception and surveys the current state of the art in parapsychological research in the United States and abroad. The nature of this perceptual channel is examined in a series of experiments carried out in the Electronics and Bioengineering Laboratory of Stanford Research Institute. The perceptual modality most extensively investigated is the ability of both experienced subjects and inexperienced volunteers to view, by innate mental processes, remote geographical or technical targets including buildings, roads, and laboratory apparatus. The accumulated data indicate that the phenomenon is not a sensitive function of distance, and Faraday cage shielding does not in any apparent way degrade the quality and accuracy of perception. On the basis of this research, some areas of physics are suggested from which a description or explanation of the phenomenon could be forthcoming.

## I. INTRODUCTION

IT IS THE PROVINCE of natural science to investigate nature, impartially and without prejudice" [1]. Nowhere in scientific inquiry has this dictum met as great a challenge as in the area of so-called extrasensory perception (ESP), the detection of remote stimuli not mediated by the usual sensory processes. Such phenomena, although under scientific consideration for over a century, have historically been fraught with unreliability and controversy, and validation of the phenomena by accepted scientific methodology has been slow in coming. Even so, a recent survey conducted by the British publication *New Scientist* revealed that 67 percent of nearly 1500 responding readers (the majority of whom are working scientists and technologists) considered ESP to be an established fact or a likely possibility, and 88 percent held the investigation of ESP to be a legitimate scientific undertaking [2].

A review of the literature reveals that although experiments by reputable researchers yielding positive results were begun over a century ago (e.g., Sir William Crookes' study of D. D. Home, 1860's) [3], many consider the study of these phenomena as only recently emerging from the realm of quasi-science. One reason for this is that, despite experimental results, no satisfactory theoretical construct had been advanced to correlate data or to predict new experimental outcomes. Consequently, the area in question remained for a long time in the recipe stage reminiscent of electrodynamics before the

unification brought about by the work of Ampere, Faraday, and Maxwell. Since the early work, however, we have seen the development of information theory, quantum theory, and neurophysiological research, and these disciplines provide powerful conceptual tools that appear to bear directly on the issue. In fact, several physicists (Section V) are now of the opinion that these phenomena are not at all inconsistent with the framework of modern physics: the often-held view that observations of this type are *a priori* incompatible with known laws is erroneous in that such a concept is based on the naive realism prevalent before the development of quantum theory. In the emerging view, it is accepted that research in this area can be conducted so as to uncover not just a catalog of interesting events, but rather patterns of cause-effect relationships of the type that lend themselves to analysis and hypothesis in the forms with which we are familiar in the physical sciences. One hypothesis is that information transfer under conditions of sensory shielding is mediated by extremely low-frequency (ELF) electromagnetic waves, a proposal that does not seem to be ruled out by any obvious physical or biological facts. Further, the development of information theory makes it possible to characterize and quantify the performance of a communications channel regardless of the underlying mechanism.

For the past three years, we have had a program in the Electronics and Bioengineering Laboratory of the Stanford Research Institute (SRI) to investigate those facets of human perception that appear to fall outside the range of well-understood perceptual/processing capabilities. Of particular interest is a human information-accessing capability that we call "remote viewing." This phenomenon pertains to the ability of certain individuals to access and describe, by means of mental processes, information sources blocked from ordinary perception, and generally accepted as secure against such access.

In particular, the phenomenon we have investigated most extensively is the ability of a subject to view remote geographical locations up to several thousand kilometers distant from his physical location (given only a known person on whom to target).<sup>1</sup> We have carried out more than fifty experiments under controlled laboratory conditions with several individuals whose remote perceptual abilities have been developed sufficiently to allow them at times to describe correctly—often in great detail—geographical or technical material such as buildings, roads, laboratory apparatus, and the like.

As observed in the laboratory, the basic phenomenon appears to cover a range of subjective experiences variously referred to

Manuscript received July 25, 1975; revised November 7, 1975. The submission of this paper was encouraged after review of an advance proposal. This work was supported by the Foundation for Parapsensory Investigation and the Parapsychology Foundation, New York, NY; the Institute of Noetic Sciences, Palo Alto, CA; and the National Aeronautics and Space Administration, under Contract NAS 7-100.

The authors are with the Electronics and Bioengineering Laboratory, Stanford Research Institute, Menlo Park, CA 94025.

<sup>1</sup>Our initial work in this area was reported in *Nature* [4], and reprinted in the *IEEE Commun. Soc. Newsletter*, vol. 13, Jan. 1975.

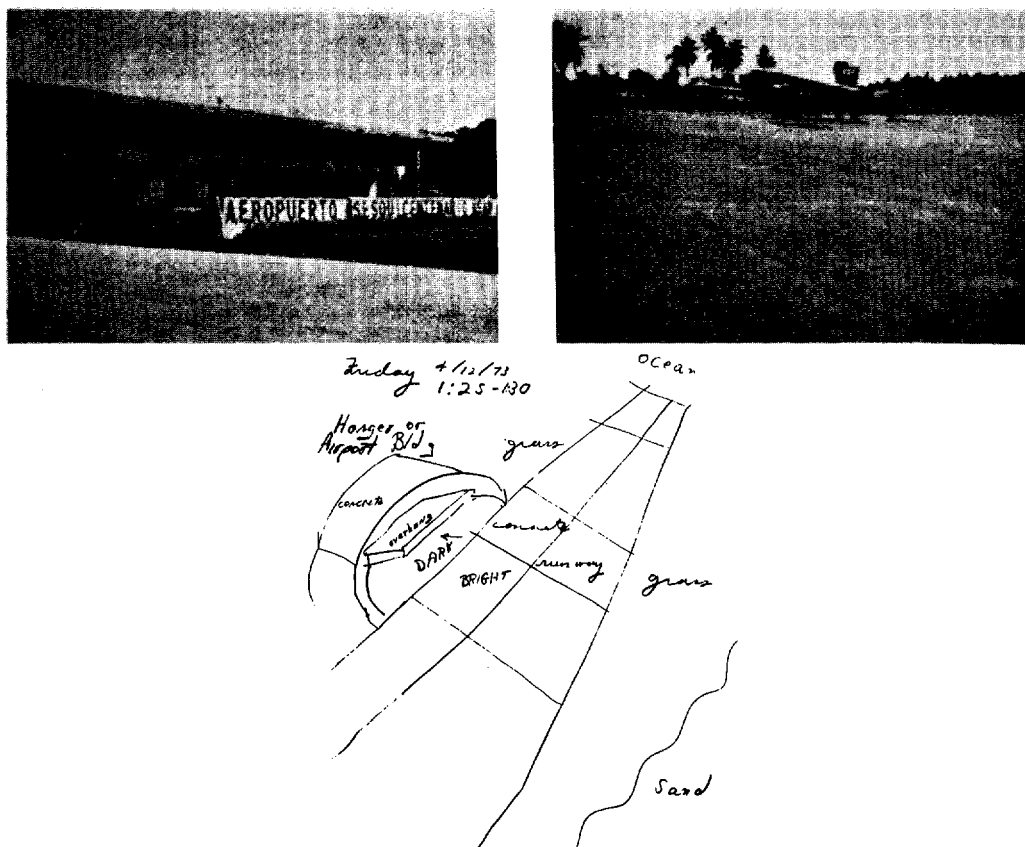

Fig. 1. Airport in San Andres, Colombia, used as remote-viewing target, along with sketch produced by subject in California.

in the literature as autoscapy (in the medical literature); exteriorization or disassociation (psychological literature); simple clairvoyance, traveling clairvoyance, or out-of-body experience (parapsychological literature); or astral projection (occult literature). We choose the term "remote viewing" as a neutral descriptive term free from prior associations and bias as to mechanisms.

The development at SRI of a successful experimental procedure to elicit this capability has evolved to the point where persons such as visiting government scientists and contract monitors, with no previous exposure to such concepts, have learned to perform well; and subjects who have trained over a one-year period have performed excellently under a variety of experimental conditions. Our accumulated data thus indicate that both specially selected and unselected persons can be assisted in developing remote perceptual abilities up to a level of useful information transfer.

In experiments of this type, we have three principal findings. First, we have established that it is possible to obtain significant amounts of accurate descriptive information about remote locations. Second, an increase in the distance from a few meters up to 4000 km separating the subject from the scene to be perceived does not in any apparent way degrade the quality or accuracy of perception. Finally, the use of Faraday cage electrical shielding does not prevent high-quality descriptions from being obtained.

To build a coherent theory for the explanation of these phenomena, it is necessary to have a clear understanding of what constitutes the phenomena. In this paper, we first briefly summarize previous efforts in this field in Section II. We then present in Sections III and IV the results of a series of more

than fifty experiments with nine subjects carried out in our own laboratory, which represent a sufficiently stable data base to permit testing of various hypotheses concerning the functioning of this channel. Finally, in Section V, we indicate those areas of physics and information theory that appear to be relevant to an understanding of certain aspects of the phenomena.

First, however, we present an illustrative example generated in an early pilot experiment. As will be clear from our later discussion, this is not a "best-ever" example, but rather a typical sample of the level of proficiency that can be reached and that we have come to expect in our research.

Three subjects participated in a long-distance experiment focusing on a series of targets in Costa Rica. These subjects said they had never been to Costa Rica. In this experiment, one of the experimenters (Dr. Puthoff) spent ten days traveling through Costa Rica on a combination business/pleasure trip. This information was all that was known to the subjects about the traveler's itinerary. The experiment called for Dr. Puthoff to keep a detailed record of his location and activities, including photographs of each of seven target days at 1330 PDT. A total of twelve daily descriptions were collected before the traveler's return: six responses from one subject, five from another, and one from a third.

The third subject who submitted the single response supplied a drawing for a day in the middle of the series. (The subject's response, together with the photographs taken at the site, are shown in Fig. 1). Although Costa Rica is a mountainous country, the subject unexpectedly perceived the traveler at a beach and ocean setting. With some misgiving, he described an airport on a sandy beach and an airstrip with the ocean at the

end (correct). An airport building also was drawn, and shown to have a large rectangular overhang (correct). The traveler had taken an unplanned one-day side trip to an offshore island and at the time of the experiment had just disembarked from a plane at a small island airport as described by the subject 4000 km away. The sole discrepancy was that the subject's drawing showed a Quonset-hut type of building in place of the rectangular structure.

The above description was chosen as an example to illustrate a major point observed a number of times throughout the program to be described. Contrary to what may be expected, a subject's description does not necessarily portray what may reasonably be expected to be correct (an educated or "safe" guess), but often runs counter even to the subject's own expectations.

We wish to stress again that a result such as the above is not unusual. The remaining submissions in this experiment provided further examples of excellent correspondences between target and response. (A target period of poolside relaxation was identified; a drive through a tropical forest at the base of a truncated volcano was described as a drive through a jungle below a large bare table mountain; a hotel-room target description, including such details as rug color, was correct; and so on.) So as to determine whether such matches were simply fortuitous—that is, could reasonably be expected on the basis of chance alone—Dr. Puthoff was asked after he had returned to blind match the twelve descriptions to his seven target locations. On the basis of this conservative evaluation procedure, which vastly underestimates the statistical significance of the individual descriptions, five correct matches were obtained. This number of matches is significant at  $p = 0.02$  by exact binomial calculation.<sup>2</sup>

The observation of such unexpectedly high-quality descriptions early in our program led to a large-scale study of the phenomenon at SRI under secure double-blind conditions (i.e., target unknown to experimenters as well as subjects), with independent random target selection and blind judging. The results, presented in Sections III and IV, provide strong evidence for the robustness of this phenomenon whereby a human perceptual modality of extreme sensitivity can detect complex remote stimuli.

## II. BACKGROUND

Although we are approaching the study of these phenomena as physicists, it is not yet possible to separate ourselves entirely from the language of the nineteenth century when the laboratory study of the paranormal was begun. Consequently, we continue to use terms such as "paranormal," "telepathy," and the like. However, we intend only to indicate a process of information transfer under conditions generally accepted as secure against such transfer and with no prejudice or occult assumptions as to the mechanisms involved. As in any other scientific pursuit, the purpose is to collect the observables that result from experiments and to try to determine the functional relationships between these observables and the laws of physics as they are currently understood.

<sup>2</sup>The probability of a correct daily match by chance for any given transcript is  $p = \frac{1}{7}$ . Therefore, the probability of at least five correct matches by chance out of twelve tries can be calculated from

$$p = \sum_{i=5}^{12} \frac{12!}{i!(12-i)!} \left(\frac{1}{7}\right)^i \left(\frac{6}{7}\right)^{(12-i)} = 0.02.$$

Organized research into so-called psychic functioning began roughly in the time of J. J. Thomson, Sir Oliver Lodge, and Sir William Crookes, all of whom took part in the founding of the Society for Psychical Research (SPR) in 1882 in England. Crookes, for example, carried out his principal investigations with D. D. Home, a Scotsman who grew up in America and returned to England in 1855 [3]. According to the notebooks and published reports of Crookes, Home had demonstrated the ability to cause objects to move without touching them. We should note in passing that, Home, unlike most subjects, worked only in the light and spoke out in the strongest possible terms against the darkened seance rooms popular at the time [5].

Sir William Crookes was a pioneer in the study of electrical discharge in gases and in the development of vacuum tubes, some types of which still bear his name. Although everything Crookes said about electron beams and plasmas was accepted, nothing he said about the achievements of D. D. Home ever achieved that status. Many of his colleagues, who had not observed the experiments with Home, stated publicly that they thought Crookes had been deceived, to which Crookes angrily responded:

Will not my critics give me credit for some amount of common sense? Do they not imagine that the obvious precautions, which occur to them as soon as they sit down to pick holes in my experiments, have occurred to me also in the course of my prolonged and patient investigation? The answer to this, as to all other objections is, prove it to be an error, by showing where the error lies, or if a trick, by showing how the trick is performed. Try the experiment fully and fairly. If then fraud be found, expose it; if it be a truth, proclaim it. This is the only scientific procedure, and it is that I propose steadily to pursue [3].

In the United States, scientific interest in the paranormal was centered in the universities. In 1912, John Coover [6] was established in the endowed Chair of Psychical Research at Stanford University. In the 1920's, Harvard University set up research programs with George Estabrooks and L. T. Troland [7], [8]. It was in this framework that, in 1930, William McDougall invited Dr. J. B. Rhine and Dr. Louisa Rhine to join the Psychology Department at Duke University [9]. For more than 30 years, significant work was carried out at Rhine's Duke University Laboratory. To examine the existence of paranormal perception, he used the now-famous ESP cards containing a boldly printed picture of a star, cross, square, circle, or wavy lines. Subjects were asked to name the order of these cards in a freshly shuffled deck of twenty-five such cards. To test for telepathy, an experimenter would look at the cards one at a time, and a subject suitably separated from the sender would attempt to determine which card was being viewed.

Dr. J. B. Rhine together with Dr. J. G. Pratt carried out thousands of experiments of this type under widely varying conditions [10]. The statistical results from these experiments indicated that some individuals did indeed possess a paranormal perceptual ability in that it was possible to obtain an arbitrarily high degree of improbability by continued testing of a gifted subject.

The work of Rhine has been challenged on many grounds, however, including accusations of improper handling of statistics, error, and fraud. With regard to the statistics, the general consensus of statisticians today is that if fault is to be found in Rhine's work, it would have to be on other than statistical grounds [11]. With regard to the accusations of fraud, the

most celebrated case of criticism of Rhine's work, that of G. R. Price [12], ended 17 years after it began when the accusation of fraud was retracted by its author in an article entitled "Apology to Rhine and Soal," published in the same journal in which it was first put forward [13]. It should also be noted that parapsychological researchers themselves recently exposed fraud in their own laboratory when they encountered it [14].

At the end of the 1940's, Prof. S. G. Soal, an English mathematician working with the SPR, had carried out hundreds of card guessing experiments involving tens of thousands of calls [15]. Many of these experiments were carried out over extended distances. One of the most notable experiments was conducted with Mrs. Gloria Stewart between London and Antwerp. This experiment gave results whose probability of occurring by chance were less than  $10^{-8}$ . With the publication of *Modern Experiments in Telepathy* by Soal and Bateman (both of whom were statisticians), it appeared that card guessing experiments produced significant results, on the average.<sup>3</sup>

The most severe criticism of all this work, a criticism difficult to defend against in principle, is that leveled by the well-known British parapsychological critic C. E. M. Hansel [17], who began his examination of the ESP hypothesis with the stated assumption, "In view of the *a priori* arguments against it we know in advance that telepathy, etc., cannot occur." Therefore, based on the "*a priori* unlikelihood" of ESP, Hansel's examination of the literature centered primarily on the possibility of fraud, by subjects or investigators. He reviewed in depth four experiments which he regarded as providing the best evidence of ESP: the Pearce-Pratt distance series [18]; the Pratt-Woodruff [19] series, both conducted at Duke; and Soal's work with Mrs. Stewart and Basil Shackleton [15], as well as a more recent series by Soal and Bowden [20]. Hansel showed, in each case, how fraud *could* have been committed (by the experimenters in the Pratt-Woodruff and Soal-Bateman series, or by the subjects in the Pearce-Pratt and Soal-Bowden experiments). He gave no direct evidence that fraud *was* committed in these experiments, but said, "If the result could have arisen through a trick, the experiment must be considered unsatisfactory proof of ESP, *whether or not it is finally decided that such a trick was in fact used*" [17, p. 18]. As discussed by Honorton in a review of the field [21], Hansel's conclusion after 241 pages of careful scrutiny therefore was that these experiments were not "fraud-proof" and therefore in principle could not serve as conclusive proof of ESP.

Even among the supporters of ESP research and its results, there remained the consistent problem that many successful subjects eventually lost their ability and their scores gradually drifted toward chance results. This decline effect in no way erased their previous astronomical success; but it was a disappointment since if paranormal perception is a natural ability, one would like to see subjects improving with practice rather than getting worse.

One of the first successful attempts to overcome the decline effect was in Czechoslovakia in the work of Dr. Milan Ryzl, a chemist with the Institute of Biology of the Czechoslovakian Academy of Science and also an amateur hypnotist [22]. Through the use of hypnosis, together with feedback and

reinforcement, he developed several outstanding subjects, one of whom, Pavel Stepanek, has worked with experimenters around the world for more than 10 years.

Ryzl's pioneering work came as an answer to the questions raised by the 1956 CIBA Foundation conference on extrasensory perception. The CIBA Chemical Company has annual meetings on topics of biological and chemical interest, and that same year they assembled several prominent parapsychologists to have a state-of-the-art conference on ESP [23]. The conference concluded that little progress would be made in parapsychology research until a repeatable experiment could be found; namely, an experiment that different experimenters could repeat at will and that would reliably yield a statistically significant result.

Ryzl had by 1962 accomplished that goal. His primary contribution was a decision to interact with the subject as a person, to try to build up his confidence and ability. His protocol depended on "working with" rather than "running" his subjects. Ryzl's star subject, Pavel Stepanek, has produced highly significant results with many contemporary researchers [24]-[29]. In these experiments, he was able to tell with 60-percent reliability whether a hidden card was green side or white side up, yielding statistics of a million to one with only a thousand trials.

As significant as such results are statistically, the information channel is imperfect, containing noise along with the signal. When considering how best to use such a channel, one is led to the communication theory concept of the introduction of redundancy as a means of coding a message to combat the effects of a noisy channel [30]. A prototype experiment by Ryzl using such techniques has proved to be successful. Ryzl had an assistant select randomly five groups of three digits each. These 15 digits were then encoded into binary form and translated into a sequence of green and white cards in sealed envelopes. By means of repeated calling and an elaborate majority vote protocol, Ryzl was able after 19 350 calls by Stepanek (averaging 9 s per call) to correctly identify all 15 numbers, a result significant at  $p = 10^{-15}$ . The hit rate for individual calls was 61.9 percent, 11 978 hits, and 7372 misses [31].

*Note Added in Proof:* It has been brought to our attention that a similar procedure was recently used to transmit without error the word "peace" in International Morse Code (J. C. Carpenter, "Toward the effective utilization of enhanced weak-signal ESP effects," presented at the Annual Meeting of the American Association for the Advancement of Science, New York, NY, Jan. 27, 1975).

The characteristics of such a channel can be specified in accordance with the precepts of communication theory. The bit rate associated with the information channel is calculated from [30]

$$R = H(x) - H_y(x) \quad (1)$$

where  $H(x)$  is the uncertainty of the source message containing symbols with *a priori* probability  $p_i$ :

$$H(x) = - \sum_{i=1}^2 p_i \log_2 p_i \quad (2)$$

and  $H_y(x)$  is the conditional entropy based on the *a posteriori* probabilities that a received signal was actually transmitted:

$$H_y(x) = - \sum_{i,j=1}^2 p(i, j) \log_2 p_i(j). \quad (3)$$

<sup>3</sup>Recently, some of the early Soal experiments have been criticized [16]. However, his long-distance experiments cited here were judged in a double-blind fashion of the type that escaped the criticism of the early experiments.

For Stepanek's run, with  $p_i = \frac{1}{2}$ ,  $p_j(j) = 0.619$ , and an average time of 9 s per choice, we have a source uncertainty  $H(x) = 1$  bit and a calculated bit rate

$$R \approx 0.041 \text{ bit/symbol}$$

or

$$R/T \approx 0.0046 \text{ bit/s.}$$

(Since the 15-digit number (49.8 bits) actually was transmitted at the rate of  $2.9 \times 10^{-4}$  bit/s, an increase in bit rate by a factor of about 20 could be expected on the basis of a coding scheme more optimum than that used in the experiments. See, for example, Appendix A.)

Dr. Charles Tart at the University of California has written extensively on the so-called decline effect. He considers that having subjects attempt to guess cards, or perform any other repetitious task for which they receive no feedback, follows the classical technique for deconditioning any response. He thus considers card guessing "a technique for extinguishing psychic functioning in the laboratory" [32].

Tart's injunctions of the mid-sixties were being heeded at Maimonides Hospital, Brooklyn, NY, by a team of researchers that included Dr. Montague Ullman, who was director of research for the hospital; Dr. Stanley Krippner; and, later, Charles Honorton. These three worked together for several years on experiments on the occurrence of telepathy in dreams. In the course of a half-dozen experimental series, they found in their week-long sessions a number of subjects who had dreams that consistently were highly descriptive of pictorial material that a remote sender was looking at throughout the night. This work is described in detail in the experimenters' book *Dream Telepathy* [33]. Honorton is continuing work of this free-response type in which the subject has no preconceived idea as to what the target may be.

In his more recent work with subjects in the waking state, Honorton is providing homogeneous stimulation to the subject who is to describe color slides viewed by another person in a remote room. In this new work, the subject listens to white noise via earphones and views an homogeneous visual field imposed through the use of Ping-Pong ball halves to cover the subject's eyes in conjunction with diffuse ambient illumination. In this so-called Ganzfeld setting, subjects are again able, now in the waking state, to give correct and often highly accurate descriptions of the material being viewed by the sender [34].

In Honorton's work and elsewhere, it apparently has been the step away from the repetitive forced-choice experiment that has opened the way for a wide variety of ordinary people to demonstrate significant functioning in the laboratory, without being bored into a decline effect.

This survey would be incomplete if we did not indicate certain aspects of the current state of research in the USSR. It is clear from translated documents and other sources [35] that many laboratories in the USSR are engaged in paranormal research.

Since the 1930's, in the laboratory of L. Vasiliev (Leningrad Institute for Brain Research), there has been an interest in the use of telepathy as a method of influencing the behavior of a person at a distance. In Vasiliev's book *Experiments in Mental Suggestion*, he makes it very clear that the bulk of his laboratory's experiments were aimed at long-distance communication combined with a form of behavior modification; for example, putting people at a distance to sleep through hypnosis [36].

Similar behavior modification types of experiments have been carried out in recent times by I. M. Kogan, Chairman of the Bioinformation Section of the Moscow Board of the Popov Society. He is a Soviet engineer who, until 1969, published extensively on the theory of telepathic communication [37]-[40]. He was concerned with three principal kinds of experiments: mental suggestion without hypnosis over short distances, in which the percipient attempts to identify an object; mental awakening over short distances, in which a subject is awakened from a hypnotic sleep at the "beamed" suggestion from the hypnotist; and long-range (intercity) telepathic communication. Kogan's main interest has been to quantify the channel capacity of the paranormal channel. He finds that the bit rate decreases from 0.1 bit/s for laboratory experiments to 0.005 bit/s for his 1000-km intercity experiments.

In the USSR, serious consideration is given to the hypothesis that telepathy is mediated by extremely low-frequency (ELF) electromagnetic propagation. (The pros and cons of this hypothesis are discussed in Section V of this paper.) In general, the entire field of paranormal research in the USSR is part of a larger one concerned with the interaction between electromagnetic fields and living organisms [41], [42]. At the First International Congress on Parapsychology and Psychotronics in Prague, Czechoslovakia, in 1973, for example, Kholodov spoke at length about the susceptibility of living systems to extremely low-level ac and dc fields. He described conditioning effects on the behavior of fish resulting from the application of 10 to 100  $\mu\text{W}$  of RF to their tank [43]. The USSR take these data seriously in that the Soviet safety requirements for steady-state microwave exposure set limits at 10  $\mu\text{W}/\text{cm}^2$ , whereas the United States has set a steady-state limit of 10  $\text{mW}/\text{cm}^2$  [44]. Kholodov spoke also about the nonthermal effects of microwaves on animals' central nervous systems. His experiments were very carefully carried out and are characteristic of a new dimension in paranormal research.

The increasing importance of this area in Soviet research was indicated recently when the Soviet Psychological Association issued an unprecedented position paper calling on the Soviet Academy of Sciences to step up efforts in this area [45]. They recommended that the newly formed Psychological Institute within the Soviet Academy of Sciences and the Psychological Institute of the Academy of Pedagogical Sciences review the area and consider the creation of a new laboratory within one of the institutes to study persons with unusual abilities. They also recommended a comprehensive evaluation of experiments and theory by the Academy of Sciences' Institute of Biophysics and Institute for the Problems of Information Transmission.

The Soviet research, along with other behavioristically oriented work, suggests that in addition to obtaining overt responses such as verbalizations or key presses from a subject, it should be possible to obtain objective evidence of information transfer by direct measurement of physiological parameters of a subject. Kamiya, Lindsley, Pribram, Silverman, Walter, and others brought together to discuss physiological methods to detect ESP functioning, have suggested that a whole range of electroencephalogram (EEG) responses such as evoked potentials (EP's), spontaneous EEG, and the contingent negative variation (CNV) might be sensitive indicators of the detection of remote stimuli not mediated by usual sensory processes [46].

Early experimentation of this type was carried out by Douglas Dean at the Newark College of Engineering. In his



search for physiological correlates of information transfer, he used the plethysmograph to measure changes in the blood volume in a finger, a sensitive indicator of autonomic nervous system functioning [47]. A plethysmographic measurement was made on the finger of a subject during telepathy experiments. A sender looked at randomly selected target cards consisting of names known to the subject, together with names unknown to him (selected at random from a telephone book). The names of the known people were contributed by the subject and were to be of emotional significance to him. Dean found significant changes in the chart recording of finger blood volume when the remote sender was looking at those names known to the subject as compared with those names randomly chosen.

Three other experiments using the physiological approach have now been published. The first work by Tart [48], a later work by Lloyd [49], and most recently the work by the authors [4] all follow a similar procedure. Basically, a subject is closeted in an electrically shielded room while his EEG is recorded. Meanwhile, in another laboratory, a second person is stimulated from time to time, and the time of that stimulus is marked on the magnetic-tape recording of the subject's EEG. The subject does not know when the remote stimulus periods are as compared with the nonstimulus periods.

With regard to choice of stimulus for our own experimentation, we noted that in previous work others had attempted, without success, to detect evoked potential changes in a subject's EEG in response to a single stroboscopic flash stimulus observed by another subject [50]. In a discussion of that experiment, Kamiya suggested that because of the unknown temporal characteristics of the information channel, it might be more appropriate to use repetitive bursts of light to increase the probability of detecting information transfer [51]. Therefore, in our study we chose to use a stroboscopic flash train of 10-s duration as the remote stimulus.

In the design of the study, we assumed that the application of the remote stimulus would result in responses similar to those obtained under conditions of direct stimulation. For example, when an individual is stimulated with a low-frequency ( $< 30$  Hz) flashing light, the EEG typically shows a decrease in the amplitude of the resting rhythm and a driving of the brain waves at the frequency of the flashes [52]. We hypothesized that if we stimulated one subject in this manner (a putative sender), the EEG of another subject in a remote room with no flash present (a receiver) might show changes in alpha (9–11 Hz) activity and possibly an EEG driving similar to that of the sender, or other coupling to the sender's EEG [53]. The receiver was seated in a visually opaque, acoustically and electrically shielded, double-walled steel room about 7 m from the sender. The details of the experiment, consisting of seven runs of thirty-six 10-s trials each (twelve periods each for 0-Hz, 6-Hz, and 16-Hz stimuli, randomly intermixed), are presented in [4]. This experiment proved to be successful. The receiver's alpha activity (9–11 Hz) showed a significant reduction in average power ( $-24$  percent,  $p < 0.04$ ) and peak power ( $-28$  percent,  $p < 0.03$ ) during 16-Hz flash stimuli as compared with periods of no-flash stimulus. [A similar response was observed for 6-Hz stimuli ( $-12$  percent in average power,  $-21$  percent in peak power), but the latter result did not reach statistical significance.] Fig. 2 shows an overlay of three averaged EEG spectra from one of the subject's 36 trial runs, displaying differences in alpha activity during the three stimulus conditions. Extensive control procedures were undertaken to determine if these

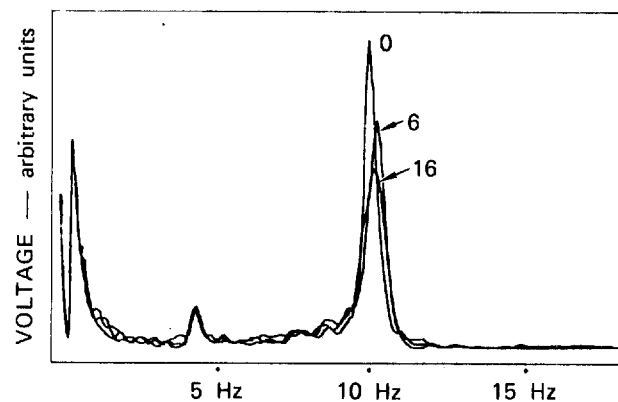

Fig. 2. Occipital EEG frequency spectra, 0–20 Hz, of one subject (H.H.) acting as receiver showing amplitude changes in the 9–11-Hz band as a function of strobe frequency. Three cases: 0-, 6-, and 16-Hz flashes (twelve trial averages).

results were produced by system artifacts, electromagnetic pickup (EMI), or subtle cueing; the results were negative [4].

As part of the experimental protocol, the subject was asked to indicate a conscious assessment for each trial (via telegraph key) as to the nature of the stimulus; analysis showed these guesses to be at chance. Thus arousal as evidenced by significant alpha blocking occurred only at the noncognitive level of physiological response. Hence the experiment provided direct physiological (EEG) evidence of perception of remote stimuli even in the absence of overt cognitive response.

Whereas in our experiments we used a remote light flash as a stimulus, Tart [48] in his work used an electrical shock to himself as sender, and Lloyd [49] simply told the sender to think of a red triangle each time a red warning light was illuminated within his view. Lloyd observed a consistent evoked potential in his subjects; whereas in our experiments and in Tart's, a reduction in amplitude and a desynchronization of alpha was observed—an arousal response. (If a subject is resting in an alpha-dominant condition and he is then stimulated, for example in any direct manner, one will observe a desynchronization and decrease in alpha power.) We consider that these combined results are evidence for the existence of noncognitive awareness of remote happenings and that they have a profound implication for paranormal research.

### III. SRI INVESTIGATIONS OF REMOTE VIEWING

Experimentation in remote viewing began during studies carried out to investigate the abilities of a New York artist, Ingo Swann, when he expressed the opinion that the insights gained during experiments at SRI had strengthened his ability (verified in other research before he joined the SRI program) to view remote locations [54]. To test Mr. Swann's assertion, a pilot study was set up in which a series of targets from around the globe were supplied by SRI personnel to the experimenters on a double-blind basis. Mr. Swann's apparent ability to describe correctly details of buildings, roads, bridges, and the like indicated that it may be possible for a subject by means of mental imagery to access and describe randomly chosen geographical sites located several miles from the subject's position and demarcated by some appropriate means. Therefore, we set up a research program to test the remote-viewing hypothesis under rigidly controlled scientific conditions.

In carrying out this program, we concentrated on what we considered to be our principal responsibility—to resolve under unambiguous conditions the basic issue of whether or not this

class of paranormal perception phenomenon exists. At all times, we and others responsible for the overall program took measures to prevent sensory leakage and subliminal cueing and to prevent deception, whether intentional or unintentional. To ensure evaluations independent of belief structures of both experimenters and judges, all experiments were carried out under a protocol, described below, in which target selection at the beginning of experiments and blind judging of results at the end of experiments were handled independently of the researchers engaged in carrying out the experiments.

Six subjects, designated S1 through S6, were chosen for the study. Three were considered as gifted or experienced subjects (S1 through S3), and three were considered as learners (S4 through S6). The *a priori* dichotomy between gifted and learners was based on the experienced group having been successful in other studies conducted before this program and the learners group being inexperienced with regard to paranormal experimentation.

The study consisted of a series of double-blind tests with local targets in the San Francisco Bay Area so that several independent judges could visit the sites to establish documentation. The protocol was to closet the subject with an experimenter at SRI and at an agreed-on time to obtain from the subject a description of an undisclosed remote site being visited by a target team. In each of the experiments, one of the six program subjects served as remote-viewing subject, and SRI experimenters served as a target demarcation team at the remote location chosen in a double-blind protocol as follows.

In each experiment, SRI management randomly chose a target location from a list of targets within a 30-min driving time from SRI; the target location selected was kept blind to subject and experimenters. The target pool consisted of more than 100 target locations chosen from a target-rich environment. (Before the experimental series began, the Director of the Information Science and Engineering Division, not otherwise associated with the experiment, established the set of locations as the target pool which remained known only to him. The target locations were printed on cards sealed in envelopes and kept in the SRI Division office safe. They were available only with the personal assistance of the Division Director who issued a single random-number selected target card that constituted the traveling orders for that experiment.)

In detail: To begin the experiment, the subject was closeted with an experimenter at SRI to wait 30 min before beginning a narrative description of the remote location. A second experimenter then obtained from the Division Director a target location from a set of traveling orders previously prepared and randomized by the Director and kept under his control. The target demarcation team, consisting of two to four SRI experimenters, then proceeded by automobile directly to the target without any communication with the subject or experimenter remaining behind. The experimenter remaining with the subject at SRI was kept ignorant of both the particular target and the target pool so as to eliminate the possibility of cueing (overt or subliminal) and to allow him freedom in questioning the subject to clarify his descriptions. The demarcation team remained at the target site for an agreed-on 15-min period following the 30 min allotted for travel.<sup>4</sup> During the observa-

tion period, the remote-viewing subject was asked to describe his impressions of the target site into a tape recorder and to make any drawings he thought appropriate. An informal comparison was then made when the demarcation team returned, and the subject was taken to the site to provide feedback.

#### A. Subject S1: Experienced

To begin the series, Pat Price, a former California police commissioner and city councilman, participated as a subject in nine experiments. In general, Price's ability to describe correctly buildings, docks, roads, gardens, and the like, including structural materials, color, ambience, and activity—often in great detail—indicated the functioning of a remote perceptual ability. A Hoover Tower target, for example, was recognized and named by name. Nonetheless, in general, the descriptions contained inaccuracies as well as correct statements. A typical example is indicated by the subject's drawing shown in Fig. 3 in which he correctly described a park-like area containing two pools of water: one rectangular, 60 by 89 ft (actual dimensions 75 by 100 ft); the other circular, diameter 120 ft (actual diameter 110 ft). He incorrectly indicated the function, however, as water filtration rather than recreational swimming. (We often observe essentially correct descriptions of basic elements and patterns coupled with incomplete or erroneous analysis of function.) As can be seen from his drawing, he also included some elements, such as the tanks shown in the upper right, that are not present at the target site. We also note an apparent left-right reversal, often observed in paranormal perception experiments.

To obtain a numerical evaluation of the accuracy of the remote-viewing experiment, the experimental results were subjected to independent judging on a blind basis by an SRI research analyst not otherwise associated with the research. The subject's response packets, which contained the nine typed unedited transcripts of the tape-recorded narratives along with any associated drawings, were unlabeled and presented in random order. While standing at each target location, visited in turn, the judge was required to blind rank order the nine packets on a scale 1 to 9 (best to worst match). The statistic of interest is the sum of ranks assigned to the target-associated transcripts, lower values indicating better matches. For nine targets, the sum of ranks could range from nine to eighty-one. The probability that a given sum of ranks  $s$  or less will occur by chance is given by [55]

$$\Pr(s \text{ or less}) = \frac{1}{N^n} \sum_{i=n}^s \sum_{l=0}^k (-1)^l \binom{n}{l} \binom{i - Nl - 1}{n - 1}$$

where  $s$  is obtained sum of ranks,  $N$  is number of assignable ranks,  $n$  is number of occasions on which rankings were made, and  $l$  takes on values from zero to the least positive integer  $k$  in  $(i - n)/n$ . (Table I is a table to enable easy application of the above formula to those cases in which  $N = n$ .) The sum in this case, which included seven direct hits out of the nine, was 16 (see Table II), a result significant at  $p = 2.9 \times 10^{-5}$  by exact calculation.

In Experiments 3, 4, and 6 through 9, the subject was secured in a double-walled copper-screen Faraday cage. The Faraday cage provides 120-dB attenuation for plane-wave radio-frequency radiation over a range of 15 kHz to 1 GHz. For magnetic fields, the attenuation is 68 dB at 15 kHz and decreases to 3 dB at 60 Hz. The results of rank order judging (Table II) indicate that the use of Faraday cage electrical

<sup>4</sup>The first subject (S1) was allowed 30 min for his descriptions, but it was found that he fatigued and had little comment after the first 15 min. The viewing time was therefore reduced to 15 min for subjects S2 through S6.

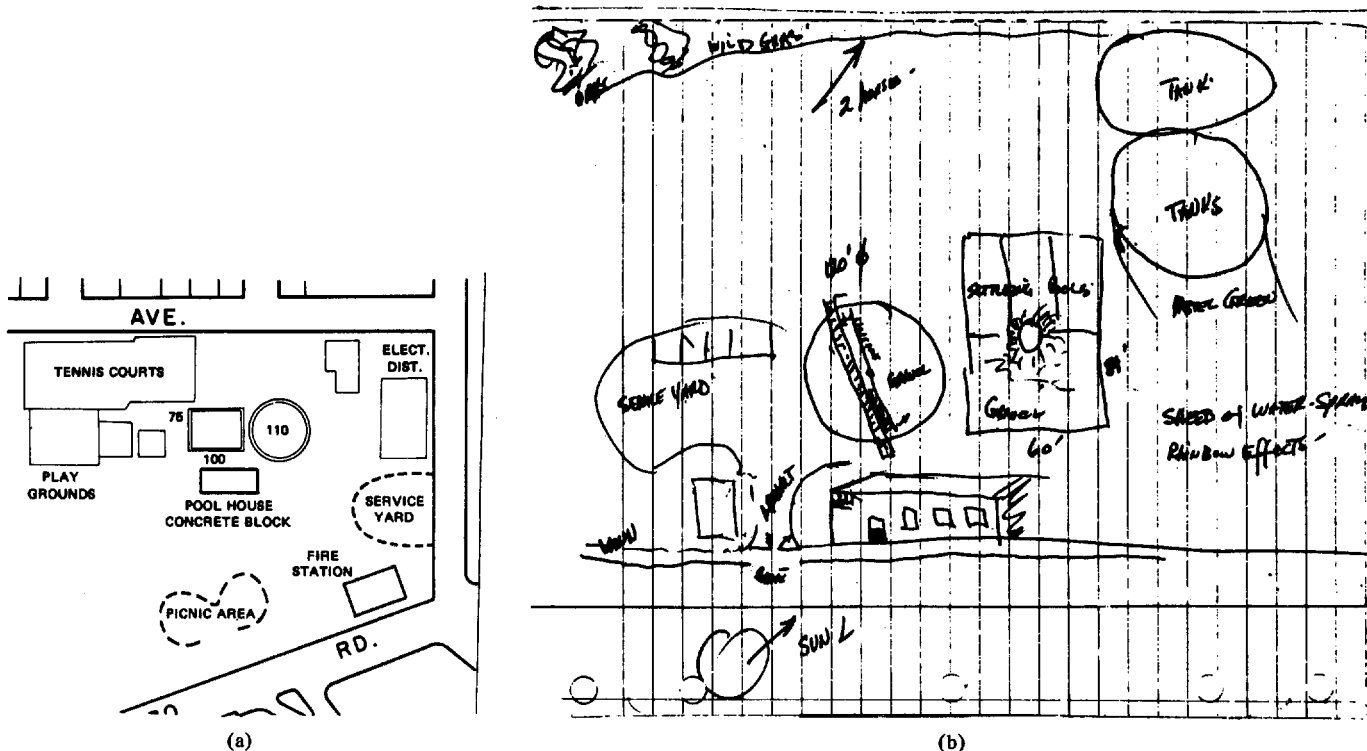

Fig. 3. Swimming pool complex as remote-viewing target. (a) City map of target location. (b) Drawing by Price (S1).

TABLE I  
CRITICAL VALUES OF SUMS OF RANKS FOR PREFERENTIAL MATCHING

Number of Assignable Ranks (N)	Probability (one-tailed) that the Indicated Sum of Ranks or Less Would Occur by Chance													
	0.20	0.10	0.05	0.04	0.025	0.01	0.005	0.002	0.001	0.0005	10 <sup>-4</sup>	10 <sup>-5</sup>	10 <sup>-6</sup>	10 <sup>-7</sup>
4	7	6	5	5	5	4	4							
5	11	10	9	8	8	7	6	6	5	5				
6	16	15	13	13	12	11	10	9	8	7	6			
7	22	20	18	18	17	15	14	12	12	11	9	8		
8	29	27	24	24	22	20	19	17	16	15	13	11	9	8
9	37	34	31	30	29	26	24	22	21	20	17	14	12	10
10	46	42	39	38	36	33	31	29	27	25	22	19	16	13
11	56	51	48	47	45	41	38	36	34	32	28	24	20	17
12	67	61	58	56	54	49	47	43	41	39	35	30	25	22

Note: This table applies only to those special cases in which the number of occasions on which objects are being ranked (n) is equal to the number of assignable ranks (N). Each entry represents the largest number that is significant at the indicated p-level. Source: R. L. Morris [55].

shielding does not prevent high-quality descriptions from being obtained.

As a backup judging procedure, a panel of five additional SRI scientists not otherwise associated with the research were asked simply to blind match the unedited typed transcripts (with associated drawings) generated by the remote viewer against the nine target locations which they independently visited in turn. The transcripts were unlabeled and presented in random order. A correct match consisted of a transcript of a given date being matched to the target of that date. Instead of the expected number of 1 match each per judge, the number of correct matches obtained by the five judges was 7, 6, 5, 3, and 3, respectively. Thus, rather than the expected total number of 5 correct matches from the judges, 24 such matches were obtained.

B. Subject S4: Learner

This experiment was designed to be a replication of our previous experiment with Price, the first replication attempted. The subject for this experiment was Mrs. Hella Hammid, a gifted professional photographer. She was selected for this series on the basis of her successful performance as a participant in the EEG experiment described earlier. Outside of that interaction, she had no previous experience with apparent paranormal functioning.

At the time we began working with Mrs. Hammid, she had no strong feelings about the likelihood of her ability to succeed in this task. This was in contrast to both Ingo Swann who had come to our laboratory fresh from a lengthy and apparently successful series of experiments with Dr. Gertrude Schneider at City College of New York [56] and Pat Price

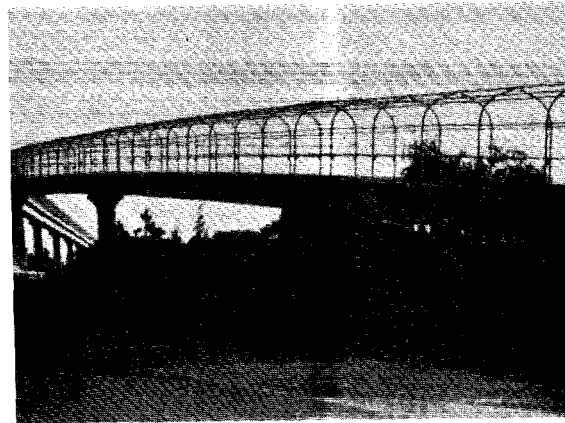
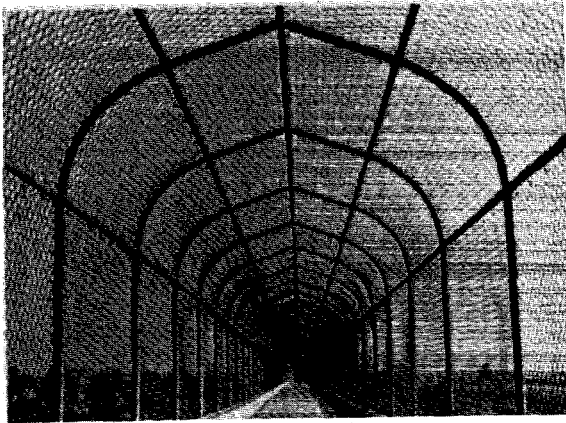

PEDESTRIAN OVERPASS TARGET

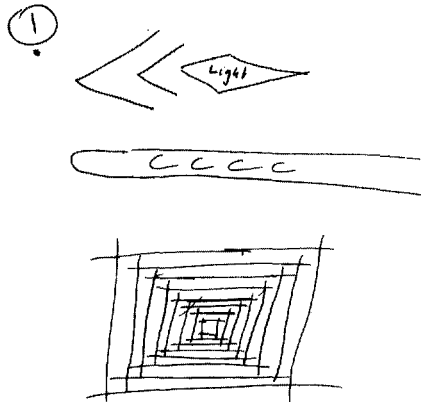

Fig. 4. Subject Hammid (S4) drawing, described as "some kind of diagonal trough up in the air."

TABLE II  
DISTRIBUTION OF RANKINGS ASSIGNED TO TRANSCRIPTS  
ASSOCIATED WITH EACH TARGET LOCATION FOR EXPERIENCED  
SUBJECT PRICE (S1)

Target Location	Distance (km)	Rank of Associated Transcript
Hoover Tower, Stanford	3.4	1
Baylands Nature Preserve, Palo Alto	6.4	1
Radio telescope, Portola Valley	6.4	1
Marina, Redwood City	6.8	1
Bridge toll plaza, Fremont	14.5	6
Drive-in theater, Palo Alto	5.1	1
Arts and Crafts Plaza, Menlo Park	1.9	1
Catholic Church, Portola Valley	8.5	3
Swimming pool complex, Palo Alto	3.4	1
Total sum of ranks		16 ( $p=2.9 \times 10^{-6}$ )

scientific rigor, one of our primary tasks as researchers is to provide an environment in which the subject feels safe to explore the possibility of paranormal perception. With a new subject, we also try to stress the nonuniqueness of the ability because from our experience paranormal functioning appears to be a latent ability that all subjects can articulate to some degree.

Because of Mrs. Hammid's artistic background, she was capable of drawing and describing visual images that she could not identify in any cognitive or analytic sense. When the target demarcation team went to a target location which was a pedestrian overpass, the subject said that she saw "a kind of trough up in the air," which she indicated in the upper part of her drawing in Fig. 4. She went on to explain, "If you stand where they are standing you will see something like this," indicating the nested squares at the bottom of Fig. 4. As it turned out, a judge standing where she indicated would have a view closely resembling what she had drawn, as can be seen from the accompanying photographs of the target location. It needs to be emphasized, however, that judges did not have access to our photographs of the site, used here for illustrative purposes only, but rather they proceeded to each of the target locations by list.

who felt that he used his remote-viewing ability in his everyday life.

In comparison with the latter two, many people are more influenced by their environment and are reluctant under public scrutiny to attempt activities that are generally thought to be impossible. Society often provides inhibition and negative feedback to the individual who might otherwise have explored his own nonregular perceptual ability. We all share an historical tradition of "the stoning of prophets and the burning of witches" and, in more modern times, the hospitalization of those who claim to perceive things that the majority do not admit to seeing. Therefore, in addition to maintaining

In another experiment, the subject described seeing "an open barnlike structure with a pitched roof." She also saw a "kind of slatted side to the structure making light and dark bars on the wall." Her drawing and a photograph of the associated bicycle shed target are shown in Fig. 5. (Subjects are encouraged to make drawings of anything they visualize and associate with the remote location because drawings they make are in general more accurate than their verbal description.)

As in the original series with Price, the results of the nine-

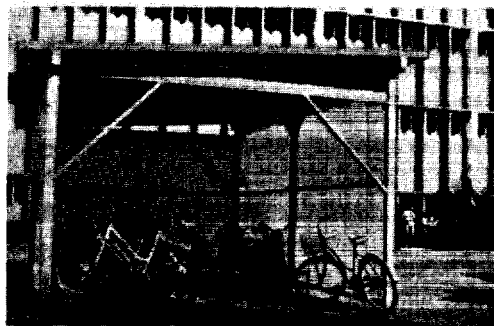

BICYCLE SHED TARGET

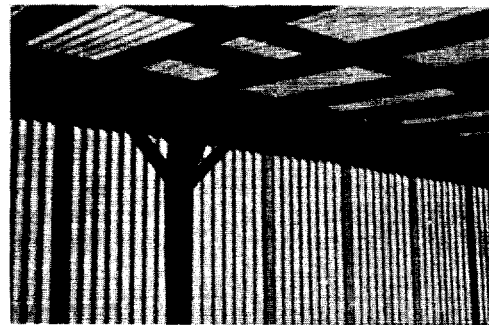

DETAIL OF BICYCLE SHED

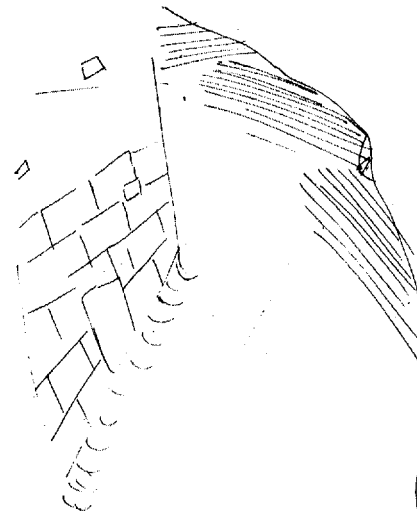
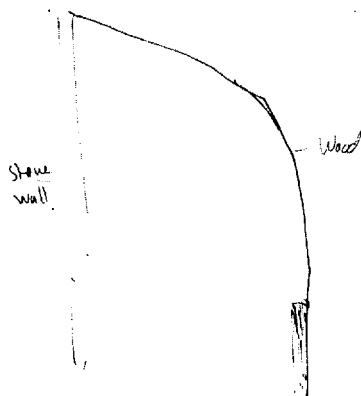

Fig. 5. Subject Hammid (S4) response to bicycle shed target described as an open "barn-like building" with "slats on the sides" and a "pitched roof."

TABLE III  
 DISTRIBUTION OF RANKINGS ASSIGNED TO TRANSCRIPTS ASSOCIATED WITH EACH TARGET LOCATION FOR LEARNER SUBJECT HAMMID (S4)

Target Location	Distance (km)	Rank of Associated Transcript
Methodist Church, Palo Alto	1.9	1
Ness Auditorium, Menlo Park	0.2	1
Merry-go-round, Palo Alto	3.4	1
Parking garage, Mountain View	8.1	2
SRI International Courtyard, Menlo Park	0.2	1
Bicycle shed, Menlo Park	0.1	2
Railroad trestle bridge, Palo Alto	1.3	2
Pumpkin patch, Menlo Park	1.3	1
Pedestrian overpass, Palo Alto	5.0	2
Total sum of ranks		13 ( $p=1.8 \times 10^{-6}$ )

experiment series were submitted for independent judging on a blind basis by an SRI research analyst not otherwise associated with the research. While at each target location, visited in turn, the judge was required to blind rank order the nine unedited typed manuscripts of the tape-recorded narratives, along with any associated drawings generated by the remote viewer, on a scale 1 to 9 (best to worst match). The sum of ranks assigned to the target-associated transcripts in this case was 13, a result significant at  $p = 1.8 \times 10^{-6}$  by exact calculation (see Table I and discussion), and included five direct hits and four second ranks (Table III).

Again, as a backup judging procedure, a panel of five additional judges not otherwise associated with the research were asked simply to blind match the unedited typed transcripts and associated drawings generated by the remote viewer, against the nine target locations which they independently visited in turn. A correct match consisted of a transcript of a given date being matched to the target of that date. Instead of the expected number of 1 match each per judge, the number of correct matches obtained by the five judges was 5, 3, 3, 2, and 2, respectively. Thus, rather than the expected total number of 5 correct matches from the judges, 15 such matches were obtained.

C. Subjects S2 and S3: Experienced

Having completed a series of 18 remote-viewing experiments, 9 each with experienced subject S1 (Price) and learner S4 (Hammid), additional replication experiments, four with each subject, were carried out with experienced subjects S2 (Elgin) and S3 (Swann) and learners S5 and S6. To place the judging on a basis comparable to that used with S1 and S4, the four transcripts each of experienced subjects S2 and S3 were combined into a group of eight for rank order judging to be compared with the similarly combined results of the learners S5 and S6.

The series with S2 (Elgin, an SRI research analyst) provided a further example of the dichotomy between verbal and drawing responses. (As with medical literature, case histories often are more illuminating than the summary of results.) The experiment described here was the third conducted with this

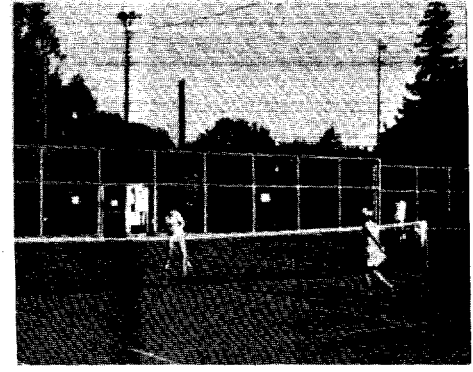
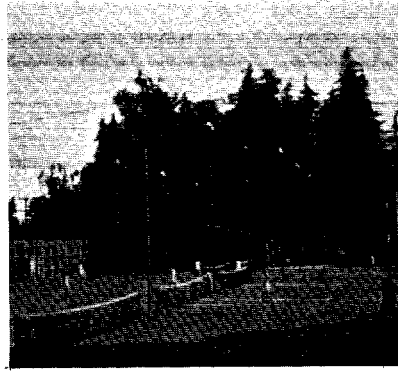
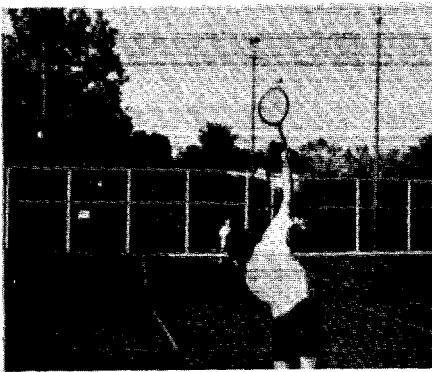

TARGET—TENNIS COURTS

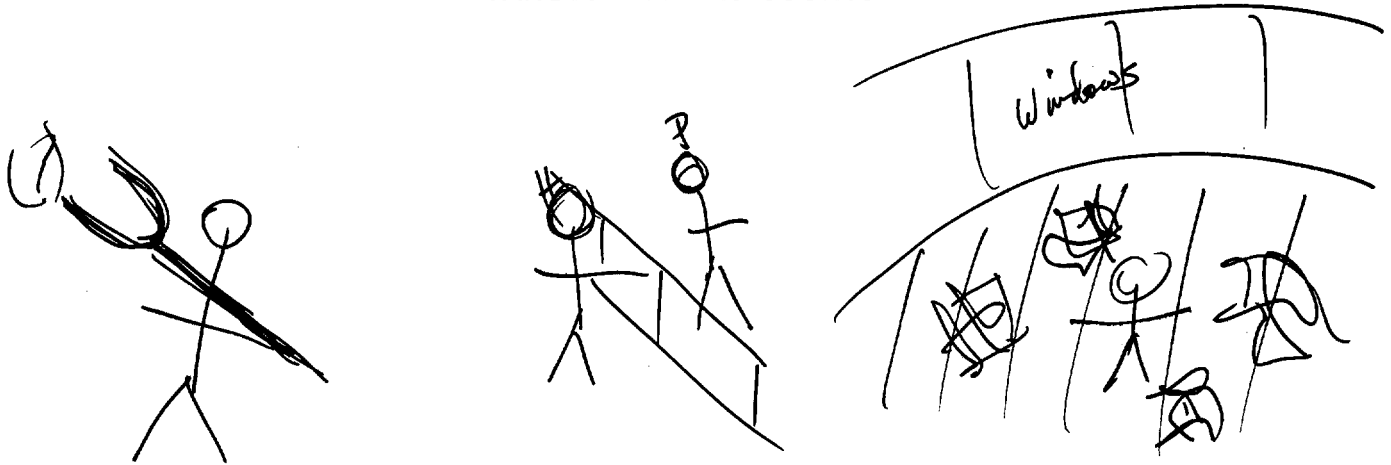

Fig. 6. Subject Elgin (S2) drawings in response to tennis court target.

subject. It was a demonstration experiment for a government visitor who had heard of our work and wanted to evaluate our experimental protocol.

In the laboratory, the subject, holding a bearing compass at arm's length, began the experiment by indicating the direction of the target demarcation team correctly to within 5°. (In all four experiments with this subject, he has always been within 10° of the correct direction in this angular assessment.) The subject then generated a 15-min tape-recorded description and the drawings shown in Fig. 6.

In discussing the drawings, Elgin indicated that he was uncertain as to the action, but had the impression that the demarcation team was located at a museum (known to him) in a particular park. In fact, the target was a tennis court located in that park about 90 m from the indicated museum. Once again, we note the characteristic (discussed earlier) of a resemblance between the target site and certain gestalt elements of the subject's response, especially in regard to the drawings, coupled with incomplete or erroneous analysis of the significances. Nonetheless, when rank ordering transcripts 1 through 8 at the site, the judge ranked this transcript as 2. This example illustrates a continuing observation that most of the correct information related to us by subjects is of a non-analytic nature pertaining to shape, form, color, and material rather than to function or name.

A second example from this group, generated by S3 (Swann), indicates the level of proficiency that can be attained with practice. In the two years since we first started working with Swann, he has been studying the problem of separating the external signal from the internal noise. In our most recent

experiments, he dictates two lists for us to record. One list contains objects that he "sees," but does not think are located at the remote scene. A second list contains objects that he thinks are at the scene. In our evaluation, he has made much progress in this most essential ability to separate memory and imagination from paranormal inputs. This is the key to bringing the remote-viewing channel to fruition with regard to its potential usefulness.

The quality of transcript that can be generated by this process is evident from the results of our most recent experiment with Swann. The target location chosen by the usual double-blind protocol was the Palo Alto City Hall. Swann described a tall building with vertical columns and "set in" windows. His sketch, together with the photograph of the site, is shown in Fig. 7. He said there was a fountain, "but I don't hear it." At the time the target team was at the City Hall during the experiment, the fountain was not running. He also made an effort to draw a replica of the designs in the pavement in front of the building, and correctly indicated the number of trees (four) in the sketch.

For the entire series of eight, four each from S2 and S3, the numerical evaluation based on blind rank ordering of transcripts at each site was significant at  $p = 3.8 \times 10^{-4}$  and included three direct hits and three second ranks for the target-associated transcripts (see Table IV).

D. Subjects S5 and S6: Learners

To complete the series, four experiments each were carried out with learner subjects S5 and S6, a man and woman on the SRI professional staff. The results in this case, taken as a



Picture of the miniature golf course  
from yesterday?

flash of green -  
foliage - wind  
trees?

a corridor of some sort -  
a walk behind the trees  
building.

lawns.

an open field.

an enclosed area of some sort -  
a quad.

a fountain -  
but I don't hear it.

harkings to the W?  
cross walks.  
basket ball court.  
open field.

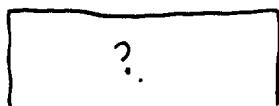
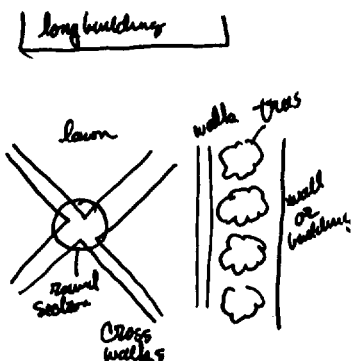

Fig. 7. Subject Swann (S3) response to City Hall target.

group, did not differ significantly from chance. For the series of eight (judged as a group of seven since one target came up twice, once for each subject), the numerical evaluation based on blind rank ordering of transcripts at each site was non-significant at  $p = 0.08$ , even though there were two direct hits and two second ranks out of the seven (see Table V).

One of the direct hits, which occurred with subject S6 in her first experiment, provides an example of the "first-time effect" that has been rigorously explored and is well-known to experimenters in the field [57]. The outbound experimenter obtained, by random protocol from the pool, a target blind to the experimenter with the subject, as is our standard procedure, and proceeded to the location. The subject, a mathematician in the computer science laboratory who had no pre-

TABLE IV  
DISTRIBUTION OF RANKINGS ASSIGNED TO TRANSCRIPTS ASSOCIATED WITH EACH TARGET LOCATION FOR EXPERIENCED SUBJECTS ELGIN (S2) AND SWANN (S3)

Subject	Target Location	Distance (km)	Rank of Associated Transcript
S2	BART Station (Transit System), Fremont	16.1	1
S2	Shielded room, SRI, Menlo Park	0.1	2
S2	Tennis court, Palo Alto	3.4	2
S2	Golf course bridge, Stanford	3.4	2
S3	City Hall, Palo Alto	2.0	1
S3	Miniature golf course, Menlo Park	3.0	1
S3	Kiosk in park, Menlo Park	0.3	3
S3	Baylands Nature Preserve, Palo Alto	6.4	3
Total sum of ranks			15 ( $p=3.8 \times 10^{-4}$ )

Solomon  
13 Nov 74.  
1040 am.

TABLE V  
DISTRIBUTION OF RANKINGS ASSIGNED TO TRANSCRIPTS ASSOCIATED WITH EACH TARGET LOCATION FOR LEARNER SUBJECTS S5 AND S6

Subject	Target Location	Distance (km)	Rank of Associated Transcript
S5	Pedestrian overpass, Palo Alto	5.0	3
S5	Railroad trestle bridge, Palo Alto	1.3	6
S5	Windmill, Portola Valley	8.5	2
S5, S6	White Plaza, Stanford (2)	3.8	1
S6	Airport, Palo Alto	5.5	2
S6	Kiosk in Park, Menlo Park	0.3	5
S6	Boathouse, Stanford	4.0	1
Total sum of ranks			20 ( $p=0.08, NS$ )

vious experience in remote viewing, began to describe a large square with a fountain. Four minutes into the experiment, she recognized the location and correctly identified it by name (see Fig. 8). (It should be noted that in the area from which the target locations were drawn there are other fountains as well, some of which were in the target pool.) As an example of the style of the narratives generated during remote viewing with inexperienced subjects and of the part played by the experimenter remaining with the subject in such a case, we have included the entire unedited text of this experiment as Appendix B.

E. Normal and Paranormal: Use of Unselected Subjects in Remote Viewing

After more than a year of following the experimental protocol described above and observing that even inexperienced subjects generated results better than expected, we initiated a series of experiments to explore further whether individuals other than putative "psychics" can demonstrate the remote-viewing ability. To test this idea, we have a continuing program to carry out additional experiments of the outdoor type with new subjects whom we have no *a priori* reason to believe have paranormal perceptual ability. To date we have collected data from five experiments with two individuals in this category: a man and a woman who were visiting government scientists interested in observing our experimental protocols. The motivation for these particular experiments was twofold. First, the experiments provide data that indicate the level of proficiency that can be expected from unselected volunteers.

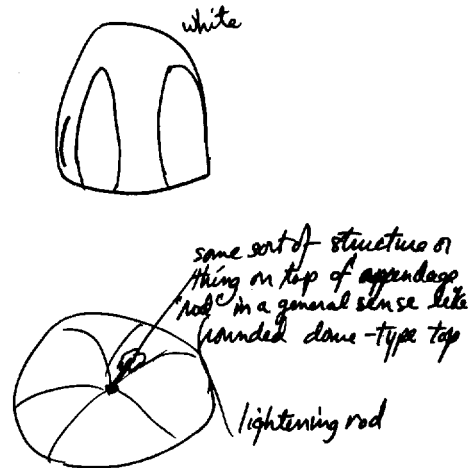
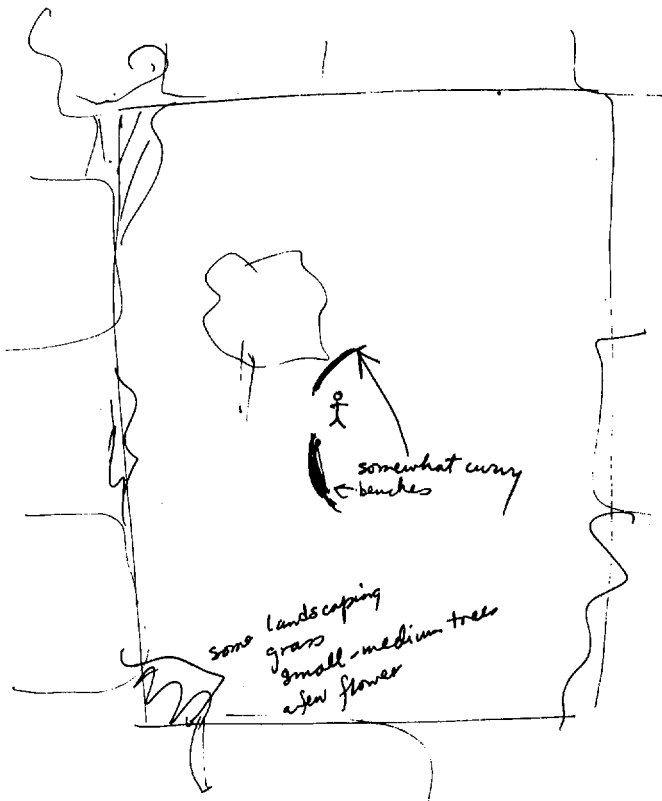
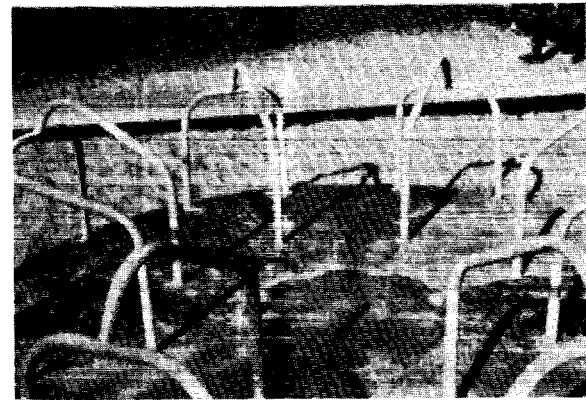
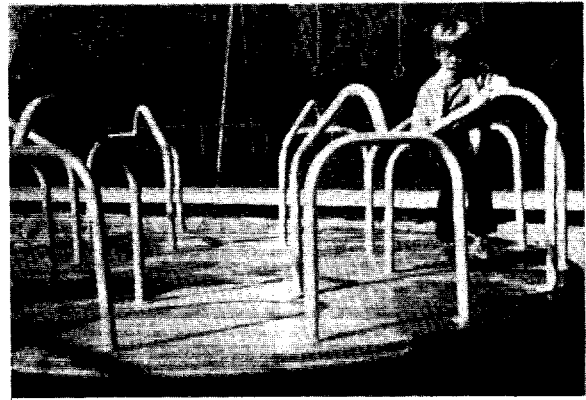

Top View

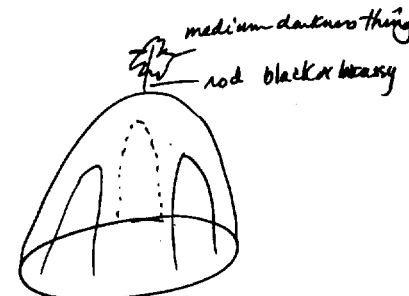

RESPONSES OF VISITING SCIENTIST SUBJECT

Fig. 9. Subject (V1) drawing of merry-go-round target.

Fig. 8. Subject (S6) drawing of White Plaza, Stanford University. Subject drew what she called "curvy benches" and then announced correctly that the place was "White Plaza at Stanford."

Second, when an individual observes a successful demonstration experiment involving another person as subject, it inevitably occurs to him that perhaps chicanery is involved. We have found the most effective way to settle this issue for the observer is to have the individual himself act as a subject so as to obtain personal experience against which our reported results can be evaluated.

The first visitor (V1) was invited to participate as a subject in a three-experiment series. All three experiments contained elements descriptive of the associated target locations; the quality of response increased with practice. The third response is shown in Fig. 9, where again the pattern elements in the drawing appeared to be a closer match than the subject's analytic interpretation of the target object as a cupola.



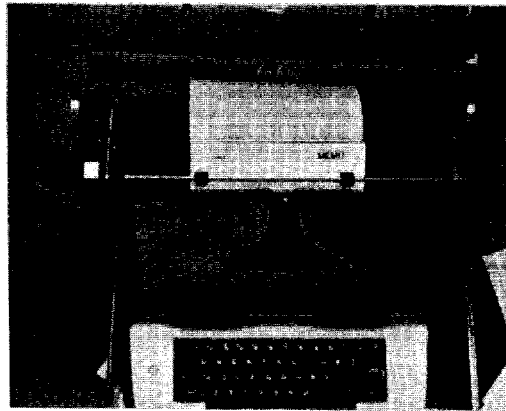
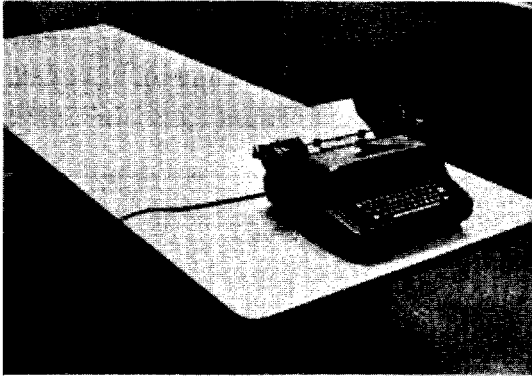

TECHNOLOGY SERIES  
 TYPEWRITER TARGET

Seems to resolve into 2 parts  
 one sitting on top of the other -  
 a machine in 2 parts -  
 white on the side  
 see the floor now - large

1123

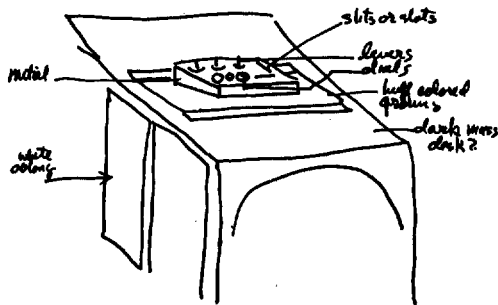

The lights must be inside  
 a green circuit.

SUBJECT SWANN (S3) RESPONSE

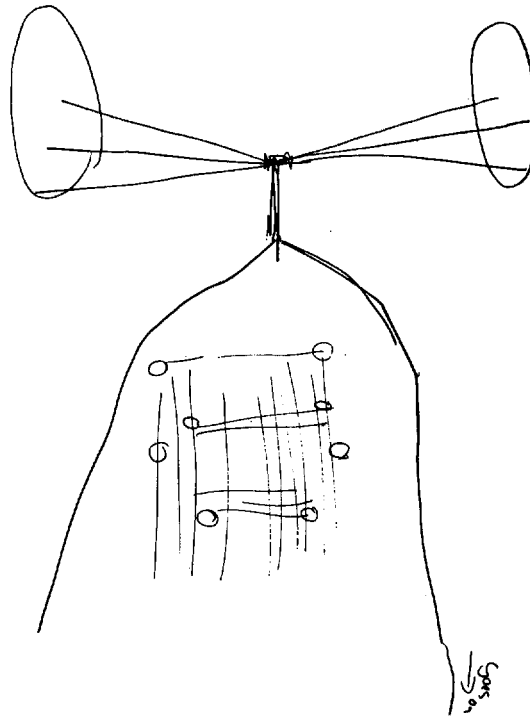

SUBJECT HAMMID (S4) RESPONSE

Fig. 10. Drawings of a typewriter target by two subjects.

The second visitor [V2] participated as a subject in two experiments. In his first experiment, he generated one of the higher signal-to-noise results we have observed. He began his narrative, "There is a red A-frame building and next to it is a large yellow thing [a tree-Editor]. Now further left there is another A-shape. It looks like a swing-set, but it is pushed down in a gully so I can't see the swings." [All correct.] He then went on to describe a lock on the front door that he said "looks like it's made of laminated steel, so it must be a Master lock." [Also correct.]

For the series of five-three from the first subject and two from the second-the numerical evaluation based on blind rank ordering of the transcripts at each site was significant at  $p = 0.017$  and included three direct hits and one second-rank for the target-associated transcripts. (See Table VI.)

TABLE VI  
 DISTRIBUTION OF RANKINGS ASSIGNED TO TRANSCRIPTS ASSOCIATED WITH EACH TARGET LOCATION FOR VISITOR SUBJECTS V1 AND V2

Subject	Target Location	Distance (km)	Rank of Associated Transcript
V1	Bridge over stream, Menlo Park	0.3	1
V1	Baylands Nature Preserve, Palo Alto	6.4	2
V1	Merry-go-round, Palo Alto	3.4	1
V2	Windmill, Portola Valley	8.5	1
V2	Apartment swimming pool, Mountain View	9.1	3
Total sum of ranks			8 ( $p=0.017$ )

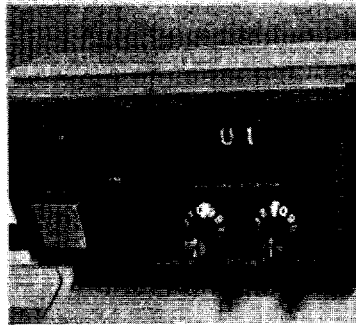
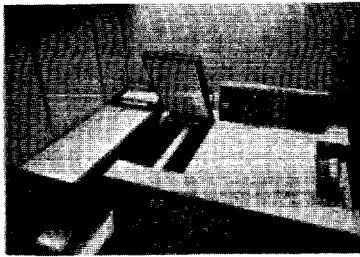

TARGET LOCATION: XEROX MACHINE  
(TECHNOLOGY SERIES)

TO ADD INTEREST TO TARGET  
LOCATION EXPERIMENTER WITH  
HIS HEAD BEING XEROXED

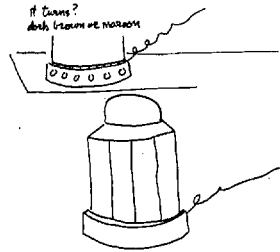

(2)

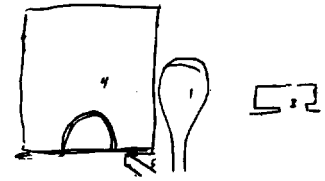

Fig. 11. Drawings by three subjects (S2, S3, and V3) for Xerox machine target. When asked to describe the square at upper left of response on the right, subject (V3) said, "There was this predominant light source which might have been a window, and a working surface which might have been the sill, or a working surface or desk." Earlier the subject had said, "I have the feeling that there is something silhouetted against the window."

Observations with unselected subjects such as those described above indicate that remote viewing may be a latent and widely distributed perceptual ability.

F. Technology Series: Short-Range Remote Viewing

Because remote viewing is a perceptual ability, we considered it important to obtain data on its resolution capabilities. To accomplish this, we turned to the use of indoor technological targets.

Twelve experiments were carried out with five different subjects, two of whom were visiting government scientists. They were told that one of the experimenters would be sent by random protocol to a laboratory within the SRI complex and that he would interact with the equipment or apparatus at that location. It was further explained that the experimenter remaining with the subject was, as usual, kept ignorant of the contents of the target pool to prevent cueing during questioning. (Unknown to subjects, targets in the pool were used with replacement; one of the goals of this particular experiment was to obtain multiple responses to a given target to investigate whether correlation of a number of subject responses would provide enhancement of the signal-to-noise ratio.) The subject was asked to describe the target both verbally (tape recorded) and by means of drawings during a time-synchronized 15-min interval in which the outbound experimenter interacted in an appropriate manner with the equipment in the target area.

In the twelve experiments, seven targets were used: a drill press, Xerox machine, video terminal, chart recorder, four-state random number generator, machine shop, and typewriter. Three of these were used twice (drill press, video terminal, and typewriter) and one (Xerox machine) came up three times in our random selection procedure.

Comparisons of the targets and subject drawings for three of the multiple-response cases (the typewriter, Xerox machine, and video terminal) are shown in Figs. 10, 11, and 12. As is apparent from these illustrations alone, the experiments provide circumstantial evidence for an information channel of useful bit rate. This includes experiments in which visiting government scientists participated as subjects (Xerox machine and video terminal) to observe the protocol. In general, it appears that use of multiple-subject responses to a single target provides better signal-to-noise ratio than target identification by a single individual. This conclusion is borne out by the judging described below.

Given that in general the drawings constitute the most accurate portion of a subject's description, in the first judging procedure a judge was asked simply to blind match only the drawings (i.e., without tape transcripts) to the targets. Multiple-subject responses to a given target were stapled together, and thus seven subject-drawing response packets were to be matched to the seven different targets for which drawings were made. The judge did not have access to our photographs of the target locations, used for illustration purposes only, but rather proceeded to each of the target locations by list. While standing at each target location, the judge was required to rank order the seven subject-drawing response packets (presented in random order) on a scale 1 to 7 (best to worst match). For seven targets, the sum of ranks could range from 7 to 49. The sum in this case, which included 1 direct hit and 4 second ranks out of the 7 (see Table VII) was 18, a result significant at  $p = 0.036$ .

In the second more detailed effort at evaluation, a visiting scientist selected at random one of the 12 data packages (a drill press experiment), sight unseen and submitted it for independent analysis to an engineer with a request for an esti-

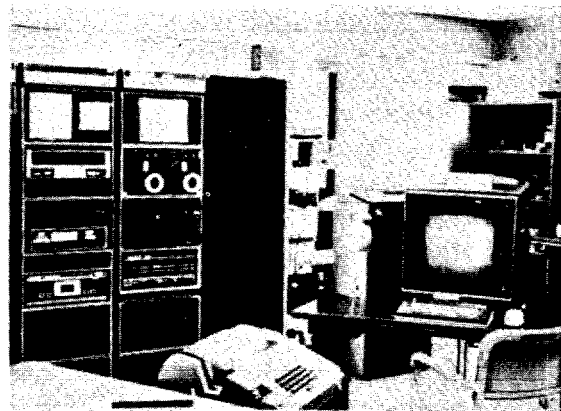
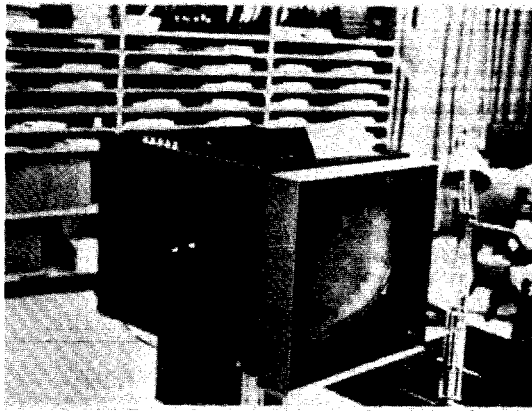

TARGET: VIDEO MONITOR FOR TEXT EDITING (TECHNOLOGY SERIES)

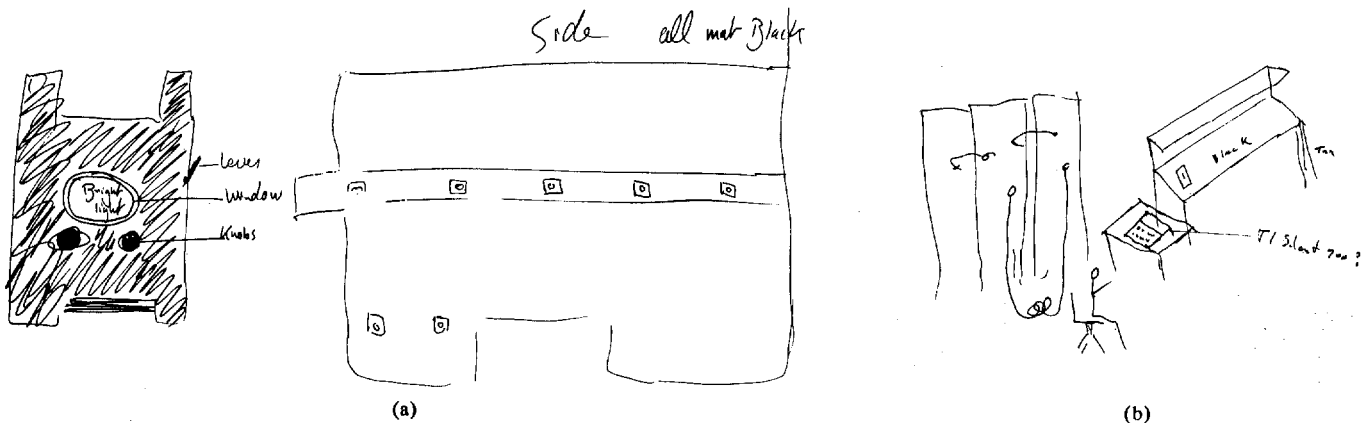

Fig. 12. Drawing by two subjects of a video monitor target. (a) Subject (S4) drawing of "box with light coming out of it . . . painted flat black and in the middle of the room." (b) Second subject (V2) saw a computer terminal with relay racks in the background.

TABLE VII  
DISTRIBUTION OF RANKINGS ASSIGNED TO SUBJECT DRAWINGS ASSOCIATED WITH EACH TARGET LOCATION

Subject	Target	Rank of Associated Drawings
S3, S4	Drill press	2
S2, S3, V3	Xerox machine	2
S4, V2	Video terminal	1
S3	Chart recorder	2
S4	Random number generator	6
S4	Machine shop	3
S3, S4	Typewriter	2
Total sum of ranks		18
		(p=0.036)

TABLE VIII  
SUMMARY: REMOTE VIEWING

Subject	Number of Experiments	p-Value, Rank Order Judging
With natural targets		
S1 (experienced)	9	$2.9 \times 10^{-5}$
S2 and S3 (experienced)	8	$3.8 \times 10^{-4}$
S4 (learner)	9	$1.8 \times 10^{-6}$
S5 and S6 (learners)	8	0.08 (NS)
V1 and V2 (learners/visitors)	5	0.017
With technology targets		
S2, S3, S4, V2, V3	12	0.036

mate as to what was being described. The analyst, blind as to the target and given only the subject's taped narrative and drawing (Fig. 13), was able, from the subject's description alone, to correctly classify the target as a "man-sized vertical boring machine."

G. Summary of Remote Viewing Results

1) Discussion: The descriptions supplied by the subjects in the experiments involving remote viewing of natural targets or laboratory apparatus, although containing inaccuracies, were sufficiently accurate to permit the judges to differentiate among various targets to the degree indicated. A summary

tabulation of the statistical evaluations of these fifty-one experiments with nine subjects is presented in Table VIII. The overall result, evaluated conservatively on the basis of a judging procedure that ignores transcript quality beyond that necessary to rank order the data packets (vastly underestimating the statistical significance of individual descriptions), clearly indicates the presence of an information channel of useful bit rate. Furthermore, it appears that the principal difference between experienced subjects and inexperienced volunteers is not that the latter never exhibit the faculty, but rather that their results are simply less reliable, more sporadic. Nevertheless, as described earlier, individual transcripts from the inexperienced group of subjects number among some of the best obtained. Such observations indicate a hypothesis that remote viewing may be a latent and widely distributed perceptual ability.

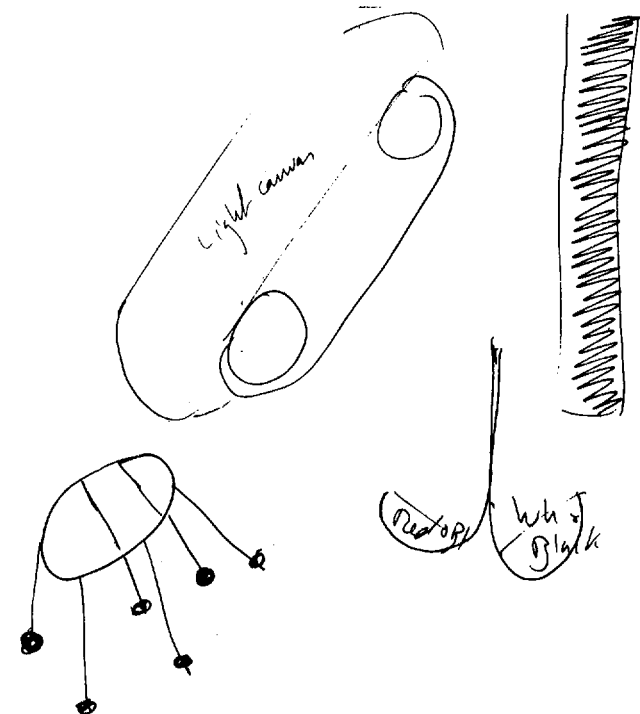
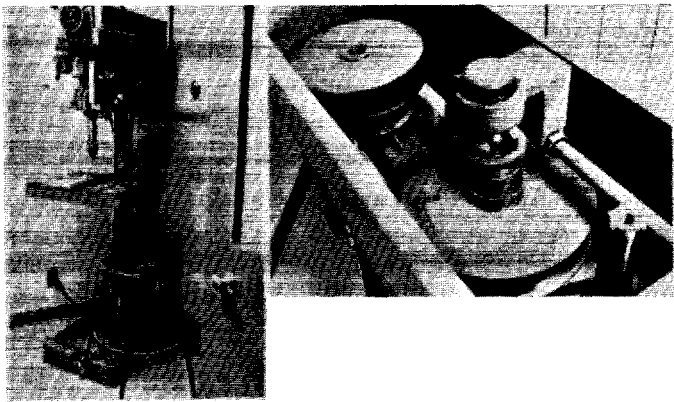

Fig. 13. Subject (S4) drawing of drill press showing belt drive, stool, and a "vertical graph that goes up and down."

Thus the primary achievement of the SRI program was the elicitation of high-quality remote viewing from individuals who agreed to act as subjects. Criticism of this claim could in principle be put forward on the basis of three potential flaws. 1) The study could involve naiveté in protocol that permits various forms of cueing, intentional or unintentional. 2) The experiments discussed could be selected out of a larger pool of experiments of which many are of poorer quality. 3) Data for the reported experiments could be edited to show only the matching elements, the nonmatching elements being discarded.

All three criticisms, however, are invalid. First, with regard to cueing, the use of double-blind protocols ensures that none of the persons in contact with the subject can be aware of the target. Second, selection of experiments for reporting did not take place; every experiment was entered as performed on a master log and is included in the statistical evaluations. Third, data associated with a given experiment remain unedited; all experiments are tape recorded and all data are included unedited in the data package to be judged and evaluated.

In the process of judging—attempting to match transcripts against targets on the basis of the information in the transcripts—some patterns and regularities in the transcript descriptions became evident, particularly regarding individual styles in remote viewing and in the perceptual form of the descriptions given by the subjects. These patterns and the judging procedure are discussed below.

a) *Styles of response:* The fifty-one transcripts were taken from nine different subjects. Comparing the transcripts of one subject with those of another revealed that each pattern tended to focus on certain aspects of the remote target complex and to exclude others, so that each had an individual pattern of response, like a signature.

Subject S3, for example, frequently responded with topographical descriptions, maps, and architectural features of the target locations. Subject S2 often focused on the behavior of the remote experimenter or the sequence of actions he carried out at the target. The transcripts of subject S4, more than those of other subjects, had descriptions of the feel of the location, and experiential or sensory gestalts—for example, light/dark elements in the scene and indoor/outdoor and enclosed/open distinctions. Prominent features of S1's transcripts were detailed descriptions of what the target persons were concretely experiencing, seeing, or doing—for example, standing on asphalt blacktop overlooking water; looking at a purple iris.

The range of any individual subject's responses was wide. Anyone might draw a map or describe the mood of the remote experimenter, but the consistency of each subject's overall approach suggests that just as individual descriptions of a directly viewed scene would differ, so these differences also occur in remote-viewing processes.

b) *Nature of the description:* The concrete descriptions that appear most commonly in transcripts are at the level of subunits of the overall scene. For example, when the target was a Xerox copy machine, the responses included (S2) a rolling object (the moving light) or dials and a cover that is lifted (S3), but the machine as a whole was not identified by name or function.

In a few transcripts, the subjects correctly identified and named the target. In the case of a computer terminal, the subject (V2) apparently perceived the terminal and the relay racks behind it. In the case of targets which were Hoover Tower and White Plaza, the subjects (S1 and S6, respectively) seemed to identify the locations through analysis of their initial images of the elements of the target.

There were also occasional incorrect identifications. Gestalts were incorrectly named; for example, swimming pools in a park were identified as water storage tanks at a water filtration plant (S1).

The most common perceptual level was thus an intermediate one—the individual elements and items that make up the target. This is suggestive of a scanning process that takes sample perceptions from within the overall environment.

When the subjects tried to make sense out of these fragmentary impressions, they often resorted to metaphors or constructed an image with a kind of perceptual inference. From a feeling of the target as an "august" and "solemn" building, a subject (S4) said it might be a library; it was a church. A pedestrian overpass above a freeway was described as a conduit (S4). A rapid transit station, elevated above the countryside, was associated with an observatory (S2). These responses seem to be the result of attempts to process partial informa-

tion: similarly, this occurs in other parapsychological experiments. These observations are compatible with the hypotheses that information received in a putative remote-viewing mode is processed piecemeal in pattern form (consistent with a low bit rate process, but not necessarily requiring it); and the errors arise in the processes of attempted integration of the data into larger patterns directed toward verbal labeling.

When the subjects augmented the verbal transcripts with drawings or sketches, these often expressed the target elements more accurately than the verbal descriptions. Thus the drawings tended to correspond to the targets more clearly and precisely than the words of the transcript.

The descriptions given by the subjects sometimes went beyond what the remote experimenter experienced, at least consciously. For example, one subject (S4) described and drew a belt drive at the top of a drill press that was invisible even to the remote experimenter who was operating the machine; another subject (S1) described a number of items behind shrubbery and thus not visible to members of the demarcation team at the site.

Curiously, objects in motion at the remote site were rarely mentioned in the transcript. For example, trains crossing the railroad trestle target were not described, though the remote experimenter stood very close to them.

Also in a few cases, the subject descriptions were inaccurate regarding size of structures. A 20-ft courtyard separating two buildings was described as 200 ft wide, and a small shed was expanded to a barn-like structure.

c) *Blind judging of transcripts:* The judging procedure entailed examining the transcripts for a given experimental series and attempting to match the transcripts with the correct targets on the basis of their correspondences. The transcripts varied from coherent and accurate descriptions to mixtures of correspondences and noncorrespondences. Since the judge did not know *a priori* which elements of the descriptions were correct or incorrect, the task was complicated, and transcripts often seemed plausibly to match more than one target. A confounding factor in these studies is that some target locations have similarities that seem alike at some level of perception. For example, a radio telescope at the top of a hill, the observation deck of a tower, and a jetty on the edge of a bay all match a transcript description of "looking out over a long distance." A lake, a fountain, and a creek may all result in an image of water for the subject. Therefore, in several cases, even correct images may not help in the conservative differential matching procedure used.

According to the judge, the most successful procedure was a careful element-by-element comparison that tested each transcript against every target and used the transcript descriptions and drawings as arguments for or against assigning the transcript to a particular target. In most cases, this resulted in either a clear conclusion or at least a ranking of probable matches; these matches were subjected to the statistical analyses presented in this paper.

2) *Summary:* In summary, we do not yet have an understanding of the nature of the information-bearing signal that a subject perceives during remote viewing. The subjects commonly report that they perceive the signal visually as though they were looking at the object or place from a position in its immediate neighborhood. Furthermore, the subjects' perceptual viewpoint has mobility in that they can shift their point of view so as to describe elements of a scene that would

not be visible to an observer merely standing at ground level and describing what he sees. (In particular, a subject often correctly describes elements not visible to the target demarcation team.) Finally, motion is seldom reported; in fact, moving objects often are unseen even when nearby static objects are correctly identified.

A comparison of the results of remote viewing (a so-called free-response task) with results of forced-choice tasks, such as the selection of one of four choices generated by a random number generator [58], reveals the following findings. From a statistical viewpoint, a subject is more likely to describe, with sufficient accuracy to permit blind matching, a remote site chosen at random than he is to select correctly one of four random numbers. Our experience with these phenomena leads us to consider that this difference in task performance may stem from fundamental signal-to-noise considerations. Two principal sources of noise in the system apparently are memory and imagination, both of which can give rise to mental pictures of greater clarity than the target to be perceived. In the random number task, a subject can create a perfect mental picture of each of the four possible outputs in his own imagination and then attempt to obtain the correct answer by a mental matching operation. The same is true for card guessing experiments. On the other hand, the subject in remote viewing is apparently more likely to approach the task with a blank mind as he attempts to perceive pictorial information from remote locations about which he may have no stored mental data.

Finally, we observe that most of the correct information that subjects relate to us is of a nonanalytic nature pertaining to shape, form, color, and material rather than to function or name. In consultation with Dr. Robert Ornstein of the Langley-Porter Neuropsychiatric Institute, San Francisco, CA, and with Dr. Ralph Kiernan of the Department of Neurology, Stanford University Medical Center, Stanford, CA, we have formed the tentative hypothesis that paranormal functioning may involve specialization characteristic of the brain's right hemisphere. This possibility is derived from a variety of evidence from clinical and neurosurgical sources which indicate that the two hemispheres of the human brain are specialized for different cognitive functions. The left hemisphere is predominantly active in verbal and other analytical functioning and the right hemisphere predominates in spatial and other holistic processing [59], [60]. Further research is necessary to elucidate the relationship between right hemisphere function and paranormal abilities. Nonetheless, we can say at this point that the remote-viewing results of the group of subjects at SRI have characteristics in common with more familiar performances that require right hemispheric function. The similarities include the highly schematicized drawings of objects in a room or of remote scenes. Verbal identification of these drawings is often highly inaccurate and the drawings themselves are frequently left-right reversed relative to the target configuration. Further, written material generally is not cognized. These characteristics have been seen in left brain-injured patients and in callosal-sectioned patients.

As a result of the above considerations, we have learned to urge our subjects simply to describe what they see as opposed to what they think they are looking at. We have learned that their unanalyzed perceptions are almost always a better guide to the true target than their interpretations of the perceived data.

## IV. CONSIDERATIONS CONCERNING TIME

If the authors may be forgiven a personal note, we wish to express that this section deals with observations that we have been reluctant to publish because of their striking apparent incompatibility with existing concepts. The motivating factor for presenting the data at this time is the ethical consideration that theorists endeavoring to develop models for paranormal functioning should be apprised of all the observable data if their efforts to arrive at a comprehensive and correct description are to be successful.

During the course of the experimentation in remote viewing (Section III), subjects occasionally volunteered the information that they had been thinking about their forthcoming participation in a remote-viewing experiment and had an image come to them as to what the target location was to be. On these occasions, the information was given only to the experimenter remaining at SRI with the subject and was unknown to the outbound experimenter until completion of the experiment. Two of these contributions were among the most accurate descriptions turned in during those experiments. Since the target location had not yet been selected when the subject communicated his perceptions about the target, we found the data difficult to contend with.

We offer these spontaneous occurrences not as proof of precognitive perception, but rather as the motivation that led us to do further work in this field. On the basis of this firsthand evidence, together with the copious literature describing years of precognition experiments carried out in various other laboratories, we decided to determine whether a subject could perform a perceptual task that required both spatial and temporal remote viewing.

It is well known and recently has been widely discussed that nothing in the fundamental laws of physics forbids the apparent transmission of information from the future to the present (discussed further in Section V). Furthermore, there is a general dictum that "in physical law, everything that is not forbidden, is required" [61]. With this in mind, we set out to conduct very well-controlled experiments to determine whether we could deliberately design and execute experiments for the sole purpose of observing precognition under laboratory conditions.

The experimental protocol was identical to that followed in previous remote-viewing experiments with but one exception. The exception was that the subject was required to describe the remote location during a 15-min period beginning 20 min before the target was selected and 35 min before the outbound experimenter was to arrive at the target location.

In detail, as shown in Table IX, each day at ten o'clock one of the experimenters would leave SRI with a stack of ten sealed envelopes from a larger pool and randomized daily, containing traveling instructions that had been prepared, but that were unknown to the two experimenters remaining with the subject. The subject for this experiment was Hella Hammid (S4) who participated in the nine-experiment series replicating the original Price work described earlier. The traveling experimenter was to drive continuously from 10:00 until 10:30 before selecting his destination with a random number generator. (The motivation for continuous motion was our observation that objects and persons in rapid motion are not generally seen in the remote-viewing mode of perception, and we wished the traveler to be a poor target until he reached his target site.) At the end of 30 min of driving, the traveling experimenter gener-

TABLE IX  
EXPERIMENTAL PROTOCOL: PRECOGNITIVE REMOTE VIEWING

Time Schedule	Experimenter/Subject Activity
10:00	Outbound experimenter leaves with 10 envelopes (containing target locations) and random number generator; begins half-hour drive
10:10	Experimenters remaining with subject in the laboratory elicit from subject a description of where outbound experimenter will be from 10:45-11:00
10:25	Subject response completed, at which time laboratory part of experiment is over
10:30	Outbound experimenter obtains random number from a random number generator, counts down to associated envelope, and proceeds to target location indicated
10:45	Outbound experimenter remains at target location for 15 minutes (10:45-11:00)

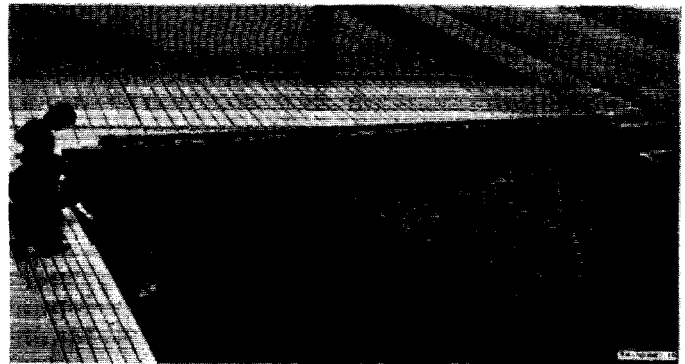

Fig. 14. Subject Hammid (S4) described "some kind of congealing tar, or maybe an area of condensed lava . . . that has oozed out to fill up some kind of boundaries."

ated a random digit from 0 to 9 with a Texas Instruments SR-51 random number generator; while still in motion, he counted down that number of envelopes and proceeded directly to the target location so as to arrive there by 10:45. He remained at the target site until 11:00, at which time he returned to the laboratory, showed his chosen target name to a security guard, and entered the experimental room.

During the same period, the protocol in the laboratory was as follows. At 10:10, the subject was asked to begin a description of the place to which the experimenter would go 35 min hence. The subject then generated a tape-recorded description and associated drawings from 10:10 to 10:25, at which time her part in the experiment was ended. Her description was thus entirely concluded 5 min before the beginning of the target selection procedure.

Four such experiments were carried out. Each of them appeared to be successful, an evaluation later verified in blind judging without error by three judges. We will briefly summarize the four experiments below.

The first target, the Palo Alto Yacht Harbor, consisted entirely of mud flats because of an extremely low tide (see Fig. 14). Appropriately, the entire transcript of the subject pertained to "some kind of congealing tar, or maybe an area of condensed lava. It looks like the whole area is covered with some kind of wrinkled elephant skin that has oozed out to fill up some kind of boundaries where (the outbound experimenter) is standing." Because of the lack of water, the dock where the remote experimenter was standing was in fact resting directly on the mud.



Fig. 15. Subject (S4) described a formal garden "very well manicured" behind a double colonnade.

Note that the subject has learned not to rush into interpretation as to the nature or purpose of the place. This is a result of our cautioning based on the observation that such efforts tend to be purely analytical and in our experience are almost invariably incorrect. If a subject can limit himself to what he sees, he is often then able to describe a scene with sufficient accuracy that an observer can perform the analysis for him and identify the place.

The second target visited was the fountain at one end of a large formal garden at Stanford University Hospital (Fig. 15). The subject gave a lengthy description of a formal garden behind a wall with a "double colonnade" and "very well manicured." When we later took the subject to the location, she was herself taken aback to find the double colonnaded wall leading into the garden just as described.

The third target was a children's swing at a small park 4.6 km from the laboratory (Fig. 16). The subject repeated again and again that the main focus of attention at the site was a "black iron triangle that the outbound experimenter had somehow walked into or was standing on." The triangle was "bigger than a man," and she heard a "squeak, squeak, about once a second," which we observe is a match to the black metal swing that did squeak.

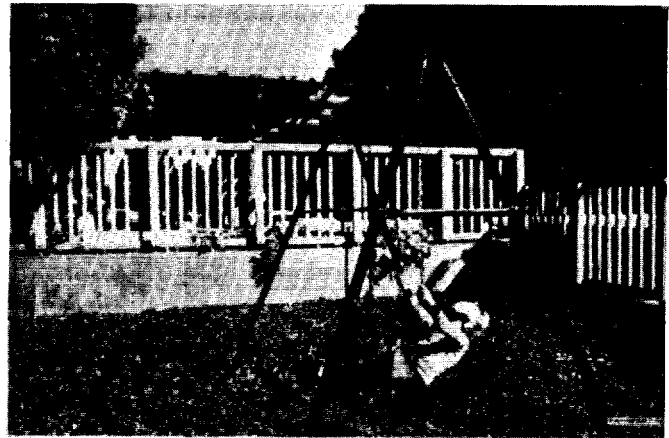

Fig. 16. Subject (S4) saw a "black iron triangle that Hal had somehow walked into" and heard a "squeak, squeak, about once a second."

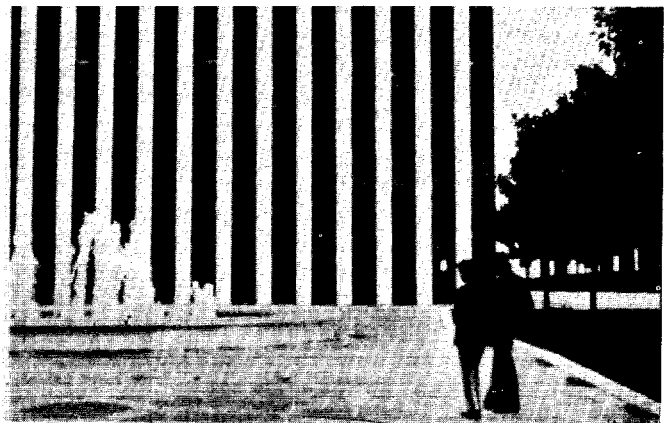

Fig. 17. Subject (S4) described a very tall structure located among city streets and covered with "Tiffany-like glass."

The final target was the Palo Alto City Hall (Fig. 17). The subject described a very, very tall structure covered with "Tiffany-like glass." She had it located among city streets and with little cubes at the base. The building is glass-covered, and the little cubes are a good match to the small elevator exit buildings located in the plaza in front of the building.

To obtain a numerical evaluation of the accuracy of the precognitive viewing, the experimental results were subjected to independent judging on a blind basis by three SRI scientists who were not otherwise associated with the experiment. The judges were asked to match the four locations, which they visited, against the unedited typed manuscripts of the tape-recorded narratives, along with the drawings generated by the remote viewer. The transcripts were presented unlabeled and in random order and were to be used without replacement. A correct match required that the transcript of a given experiment be matched with the target of that experiment. All three judges independently matched the target data to the response data without error. Under the null hypothesis (no information channel and a random selection of descriptions without replacement), each judge independently obtained a result significant at  $p = (4!)^{-1} = 0.042$ .

For reasons we do not as yet understand, the four transcripts generated in the precognition experiment show exceptional coherence and accuracy as evidenced by the fact that all of the judges were able to match successfully all of the transcripts to

the corresponding target locations. A long-range experimental program devoted to the clarification of these issues and involving a number of subjects is under way. The above four experiments are the first four carried out under this program.

Currently, we have no precise model of this spatial and temporal remote-viewing phenomenon. However, models of the universe involving higher order synchronicity or correlation have been proposed by the physicist Pauli and the psychologist Carl Jung [62].

ACAUSALITY. If natural law<sup>5</sup> were an absolute truth, then of course there could not possibly be any processes that deviate from it. But since causality<sup>5</sup> is a *statistical* truth, it holds good only on average and thus leaves room for *exceptions* which must somehow be experienceable, that is to say, *real*. I try to regard synchronistic events as acausal exceptions of this kind. They prove to be relatively independent of space and time; they relativize space and time insofar as space presents in principle no obstacle to their passage and the sequence of events in time is inverted so that it looks as if an event which has not yet occurred were causing a perception in the present.

We shall see in the next section that such a description, though poetic, has some basis in modern physical theory.

#### V. DISCUSSION

It is important to note at the outset that many contemporary physicists are of the view that the phenomena that we have been discussing are not at all inconsistent with the framework of physics as currently understood. In this emerging view, the often-held belief that observations of this type are incompatible with known laws *in principle* is erroneous, such a concept being based on the naive realism prevalent before the development of modern quantum theory and information theory.

One hypothesis, put forward by I. M. Kogan of the USSR, is that information transfer under conditions of sensory shielding is mediated by extremely low-frequency (ELF) electromagnetic waves in the 300-1000-km region [37]-[40]. Experimental support for the hypothesis is claimed on the basis of slower than inverse square attenuation, compatible with source-percipient distances lying in the induction field range as opposed to the radiation field range; observed low bit rates (0.005-0.1 bit/s) compatible with the information carrying capacity of ELF waves; apparent ineffectiveness of ordinary electromagnetic shielding as an attenuator; and standard antenna calculations entailing biologically generated currents yielding results compatible with observed signal-to-noise ratios.

M. Persinger, Psychophysiology Laboratory, Laurentian University, Toronto, Canada, has narrowed the ELF hypothesis to the suggestion that the 7.8-Hz "Schumann waves" and their harmonics propagating along the earth-ionosphere waveguide duct may be responsible. Such an hypothesis is compatible with driving by brain-wave currents and leads to certain other hypotheses such as asymmetry between east-west and west-east propagation, preferred experimental times (midnight-4 A.M.), and expected negative correlation between success and the *U* index (a measure of geomagnetic disturbance throughout the world). Persinger claims initial support for these factors on the basis of a literature search [63], [64].

On the negative side with regard to a straightforward ELF interpretation as a blanket hypothesis are the following: a) ap-

parent real-time descriptions of remote activities in sufficient detail to require a channel capacity in all probability greater than that allowed by a conventional modulation of an ELF signal; b) lack of a proposed mechanism for coding and decoding the information onto the proposed ELF carrier; and c) apparent precognition data. The hypothesis must nonetheless remain open at this stage of research, since it is conceivable that counterindication a) may eventually be circumvented on the basis that the apparent high bit rate results from a mixture of low bit rate input and high bit rate "filling in the blanks" from imagination; counterindication b) is common to a number of normal perceptual tasks and may therefore simply reflect a lack of sophistication on our part with regard to perceptual functioning [65]; and counterindication c) may be accommodated by an ELF hypothesis if advanced waves as well as retarded waves are admitted [66], [67]. Experimentation to determine whether the ELF hypothesis is viable can be carried out by the use of ELF sources as targets, by the study of parametric dependence on propagational directions and diurnal timing, and by the exploration of interference effects caused by creation of a high-intensity ELF environment during experimentation, all of which are under consideration in our laboratory and elsewhere.

Some physicists believe that the reconciliation of observed paranormal functioning with modern theory may take place at a more fundamental level—namely, at the level of the foundations of quantum theory. There is a continuing dialog, for example, on the proper interpretation of the effect of an observer (consciousness) on experimental measurement [68], and there is considerable current interest in the implications for our notions of ordering in time and space brought on by the observation [69], [70] of nonlocal correlation or "quantum interconnectedness" (to use Bohm's term [71]) of distant parts of quantum systems of macroscopic dimensions. The latter, Bell's theorem [72], emphasizes that "no theory of reality compatible with quantum theory can require spatially separated events to be independent" [73], but must permit interconnectedness of distant events in a manner that is contrary to ordinary experience [74]-[75]. This prediction has been experimentally tested and confirmed in the recent experiments of, for example, Freedman and Clauser [69], [70].

E. H. Walker and O. Costa de Beauregard, independently proposing theories of paranormal functioning based on quantum concepts, argue that observer effects open the door to the possibility of nontrivial coupling between consciousness and the environment and that the nonlocality principle permits such coupling to transcend spatial and temporal barriers [76], [77].

Apparent "time reversibility"—that is, effects (e.g., observations) apparently preceding causes (e.g., events)—though conceptually difficult at first glance, may be the easiest of apparent paranormal phenomena to assimilate within the current theoretical structure of our world view. In addition to the familiar retarded potential solutions  $f(t - r/c)$ , it is well known that the equations of, for example, the electromagnetic field admit of advanced potential solutions  $f(t + r/c)$ —solutions that would appear to imply a reversal of cause and effect. Such solutions are conventionally discarded as not corresponding to any observable physical event. One is cautioned, however, by statements such as that of Stratton in his basic text on electromagnetic theory [78].

<sup>5</sup> As usually understood.



The reader has doubtless noted that the choice of the function  $f(t - r/c)$  is highly arbitrary, since the field equation admits also a solution  $f(t + r/c)$ . This function leads obviously to an advanced time, implying that the field can be observed before it has been generated by the source. The familiar chain of cause and effect is thus reversed and this alternative solution might be discarded as logically inconceivable. However, the application of "logical" causality principles offers very insecure footing in matters such as these and we shall do better to restrict the theory to retarded action solely on the grounds that this solution alone conforms to the present physical data.

Such caution is justified by the example in the early 1920's of Dirac's development of the mathematical description of the relativistic electron that also yielded a pair of solutions, one of which was discarded as inapplicable until the discovery of the positron in 1932.

In an analysis by O. Costa de Beauregard, an argument is put forward that advanced potentials constitute a convergence toward "finality" in a manner symmetrical to the divergence of retarded potentials as a result of causality [77]. Such phenomena are generally unobservable, however, on the gross macroscopic scale for statistical reasons. This is codified in the thermodynamic concept that for an isolated system entropy (disorder) on the average increases. It is just this requirement of isolation, however, that has been weakened by the observer problem in quantum theory, and O. Costa de Beauregard argues that the finality principle is maximally operative in just those situations where the intrusion of consciousness as an ordering phenomenon results in a significant local reversal of entropy increase. At this point, further discussion of the subtleties of such considerations, though apropos, would take us far afield, so we simply note that such advanced waves, if detected, could in certain cases constitute a carrier of information precognitive to the event.

The above arguments are not intended to indicate that the precise nature of the information channel coupling remote events and human perception is understood. Rather, we intend to show only that modern theory is not without resources that can be brought to bear on the problems at hand, and we expect that these problems will, with further work, continue to yield to analysis and specification.

Furthermore, independent of the mechanisms that may be involved in remote sensing, observation of the phenomenon implies the existence of an information channel in the information-theoretic sense. Since such channels are amenable to analysis on the basis of communication theory techniques, as indicated earlier, channel characteristics such as bit rate can be determined independent of a well-defined physical channel model in the sense that thermodynamic concepts can be applied to the analysis of systems independent of underlying mechanisms. Furthermore, as we have seen from the work of Ryzl discussed in Section II, it is possible to use such a channel for error-free transmission of information if redundancy coding is used. (See also Appendix A.) Therefore, experimentation involving the collection of data under specified conditions permits headway to be made despite the formidable work that needs to be done to clarify the underlying bases of the phenomena.

## VI. CONCLUSION

For the past three years we have had a program in the Electronics and Bioengineering Laboratory of SRI to investigate those facets of human perception that appear to fall outside the range of well-understood perceptual or processing capa-

bilities. The primary achievement of this program has been the elicitation of high-quality "remote viewing"—the ability of both experienced subjects and inexperienced volunteers to view, by means of innate mental processes, remote geographical or technical targets such as roads, buildings, and laboratory apparatus. Our accumulated data from over fifty experiments with more than a half-dozen subjects indicate the following. a) The phenomenon is not a sensitive function of distance over a range of several kilometers. b) Faraday cage shielding does not appear to degrade the quality or accuracy of perception. c) Most of the correct information that subjects relate is of a nonanalytic nature pertaining to shape, form, color, and material rather than to function or name. (This aspect suggests a hypothesis that information transmission under conditions of sensory shielding may be mediated primarily by the brain's right hemisphere.) d) The principal difference between experienced subjects and inexperienced volunteers is *not* that the latter never exhibit the faculty, but rather that their results are simply less reliable. (This observation suggests the hypothesis that remote viewing may be a latent and widely distributed, though repressed, perceptual ability.)

Although the precise nature of the information channel coupling remote events and human perception is not yet understood, certain concepts in information theory, quantum theory, and neurophysiological research appear to bear directly on the issue. As a result, the working assumption among researchers in the field is that the phenomenon of interest is consistent with modern scientific thought, and can therefore be expected to yield to the scientific method. Further, it is recognized that communication theory provides powerful techniques, such as the use of redundancy coding to improve signal-to-noise ratio, which can be employed to pursue special-purpose application of the remote-sensing channel independent of an understanding of the underlying mechanisms. We therefore consider it important to continue data collection and to encourage others to do likewise; investigations such as those reported here need replication and extension under as wide a variety of rigorously controlled conditions as possible.

## APPENDIX A

### SIGNAL ENHANCEMENT IN A PARANORMAL COMMUNICATION CHANNEL BY APPLICATION OF REDUNDANCY CODING

Independent of the mechanisms that may be involved in remote sensing, observation of the phenomenon implies the existence of an information channel in the information-theoretic sense. As we have seen from the work of Ryzl discussed in Section II,<sup>6</sup> it is even possible to use such a (noisy) channel for error-free transmission of information if sufficient redundancy coding is used [30], [31]. Following is a general procedure that we have used successfully for signal enhancement.

We shall assume that the "message" consists of a stream of binary digits (0,1) of equal probability (e.g., binary sort of green/white cards as in Ryzl's case, English text encoded as in Table X and sent long distance by strobe light on/off, and so on). To combat channel noise, each binary digit to be sent through the channel requires the addition of redundancy bits (coding). Efficient coding requires a compromise between the desire to maximize reliability and the desire to minimize re-

<sup>6</sup>See also the note added in proof on the successful work done by Carpenter.

TABLE X  
 5-BIT CODE FOR ALPHANUMERIC  
 CHARACTERS

E	00000	Y	01000
T	11111	G, J	10111
N	00001	W	01001
R	11110	V	10110
I	00010	B	01010
O	11101	Ø	10101
A	00011	1	01011
S, X, Z	11100	2	10100
D	00100	3	01100
H	11011	4	10011
L	00101	5	01101
C, K, Q	11010	6	10010
F	00110	7	01110
P	11001	8	10001
U	00111	9	01111
M	11000	.	10000

Note: Alphabet characters listed in order of decreasing frequency in English text. See, for example, A. Sinkov [79]. (The low-frequency letters, X, Z, K, Q, and J, have been grouped with similar characters to provide space for numerics in a 5-bit code.) In consideration of the uneven distribution of letter frequencies in English text, this code is chosen such that 0 and 1 have equal probability.

dundancy. One efficient coding scheme for such a channel is obtained by application of a sequential sampling procedure of the type used in production-line quality control [80]. The adaptation of such a procedure to paranormal communication channels, which we now discuss, was considered first by Taetzsch [81]. The sequential method gives a rule of procedure for making one of three possible decisions following the receipt of each bit: accept 1 as the bit being transmitted; reject 1 as the bit being transmitted (i.e., accept 0); or continue transmission of the bit under consideration. The sequential sampling procedure differs from fixed-length coding in that the number of bits required to reach a final decision on a message bit is not fixed before transmission, but depends on the results accumulated with each transmission. The principal advantage of the sequential sampling procedure as compared with the other methods is that, on the average, fewer bits per final decision are required for an equivalent degree of reliability.

Use of the sequential sampling procedure requires the specification of parameters that are determined on the basis of the following considerations. Assume that a message bit (0 or 1) is being transmitted. In the absence of *a priori* knowledge, we may assume equal probability ( $p = 0.5$ ) for the two possibilities (0,1). Therefore, from the standpoint of the receiver, the probability of correctly identifying the bit being transmitted is  $p = 0.5$  because of chance alone. An operative remote-sensing channel could then be expected to alter the probability of correct identification to a value  $p = 0.5 + \psi$ , where the parameter  $\psi$  satisfies  $0 < |\psi| < 0.5$ . (The quantity may be positive or negative depending on whether the paranormal channel results in so-called psi-hitting or psi-missing.) Good psi functioning on a repetitive task has been observed to result in  $\psi = 0.12$ , as reported by Ryzl [31]. Therefore, to indicate the design procedure, let us assume a baseline psi parameter  $\psi_b = 0.1$  and design a communication system on this basis.

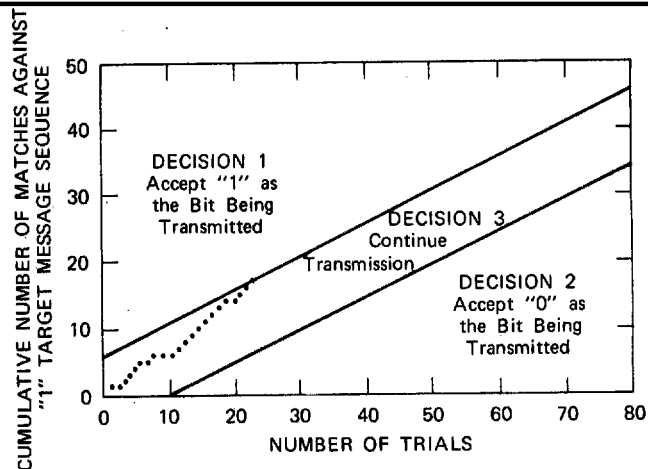

Fig. 18. Enhancement of signal-to-noise ratio by sequential sampling procedure ( $p_0 = 0.4, p_1 = 0.6, \alpha = 0.01, \beta = 0.01$ ).

The question to be addressed is whether, after repeated transmission, a given message bit is labeled a "1" at a low rate  $p_0$  commensurate with the hypothesis  $H_0$  that the bit in question is a "0," or at a higher rate  $p_1$  commensurate with the hypothesis  $H_1$  that the bit in question is indeed a "1." The decision-making process requires the specification of four parameters.

- $p_0$  The probability of labeling incorrectly a "0" message bit as a "1." The probability of labeling correctly a "0" as a "0" is  $p = 0.5 + \psi_b = 0.6$ . Therefore, the probability of labeling incorrectly a "0" as a "1" is  $1 - p = 0.4 = p_0$ .
- $p_1$  The probability of labeling correctly a "1" message bit as a "1," is given by  $p_1 = 0.5 + \psi_b = 0.6$ .
- $\alpha$  The probability of rejecting a correct identification for a "0" (Type I error). We shall take  $\alpha = 0.01$ .
- $\beta$  The probability of accepting an incorrect identification for a "1" (Type II error). We shall take  $\beta = 0.01$ .

With the parameters thus specified, the sequential sampling procedure provides for construction of a decision graph as shown in Fig. 18. The equations for the upper and lower limit lines are

$$\sum_1 = d_1 + SN$$

$$\sum_0 = -d_0 + SN$$

where

$$d_1 = \frac{\log \frac{1 - \beta}{\alpha}}{\log \frac{p_1}{p_0} \frac{1 - p_0}{1 - p_1}} \quad d_0 = \frac{\log \frac{1 - \alpha}{\beta}}{\log \frac{p_1}{p_0} \frac{1 - p_0}{1 - p_1}}$$

$$S = \frac{\log \frac{1 - p_0}{1 - p_1}}{\log \frac{p_1}{p_0} \frac{1 - p_0}{1 - p_1}}$$

in which  $S$  is the slope,  $N$  is the number of trials, and  $d_1$  and  $d_0$  are the  $y$ -axis intercepts. A cumulative record of receiver-generated responses to the target bit is compiled until either

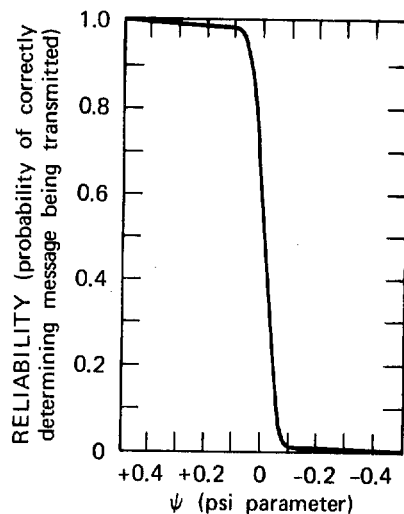

Fig. 19. Reliability curve for sequential sampling procedure ( $p_0 = 0.4$ ,  $p_1 = 0.6$ ,  $\alpha = 0.01$ ,  $\beta = 0.01$ ).

the upper or the lower limit line is reached, at which point a decision is made to accept 0 or 1 as the bit being transmitted.

Channel reliability (probability of correctly determining message being transmitted) as a function of operative psi parameter  $\psi$  is plotted in Fig. 19. As observed, the sequential sampling procedure can result in 90 percent or greater reliability with psi parameters on the order of a few percent.

Implementation of the sequential sampling procedure requires the transmission of a message coded in binary digits. Therefore, the target space must consist of dichotomous elements such as the white and green cards used in the experiments by Ryzl.

In operation, a sequence corresponding to the target bit (0 or 1) is sent and the cumulative entries are made (Fig. 18) until a decision is reached to accept either a 1 or a 0 as the bit being transmitted. At a prearranged time, the next sequence is begun and continues as above until the entire message has been received. A useful alternative, which relieves the percipient of the burden of being aware of his self-contradiction from trial to trial, consists of cycling through the entire message repetitively and entering each response on its associated graph until a decision has been reached on all message bits. The authors have used this technique successfully in a pilot study, but a discussion of this would take us beyond the intended scope of this paper.

From the results obtained in such experiments, the channel bit rate can be ascertained for the system configuration under consideration. Furthermore, bit rates for other degrees of reliability (i.e., for other  $p_0$ ,  $p_1$ ,  $\alpha$ , and  $\beta$ ) can be estimated by construction of other decision curves over the same data base and thus provide a measure of the bit rate per degree of reliability.

In summary, the procedures described here can provide for a specification of the characteristics of a remote-sensing channel under well-defined conditions. These procedures also provide for a determination of the feasibility of such a channel for particular applications.

#### APPENDIX B

##### REMOTE-VIEWING TRANSCRIPT

Following is the unedited transcript of the *first* experiment with an SRI volunteer (S6), a mathematician in the computer science laboratory, with no previous experience in remote

viewing. The target, determined by random procedure, was White's Plaza, a plaza with fountain at Stanford University (shown in Fig. 8). As is our standard protocol, the experimenter with the subject is kept ignorant of the specific target visited as well as the contents of the target pool. The experimenter's statements and questions are italics.

*Today is Monday, October 7th. It is 11:00 and this is a remote viewing experiment with Russ Targ, Phyllis Cole, and Hal Puthoff. In this experiment Hal will drive to a remote site chosen by a random process. Phyllis Cole will be the remote viewer, and Russ Targ is the monitor. We expect this experiment to start at twenty minutes after eleven and run for fifteen minutes.*

*It is just about twenty minutes after eleven and Hal should be at his target location by now.*

*Why don't you tell me what kind of pictures you see and what you think he might be doing or experiencing.*

The first thing that came to mind was some sort of a large, square kind of a shape. Like Hal was in front of it. It was a . . . not a building or something, it was a square. I don't know if it was a window, but something like that so that the bottom line of it was not at the ground. About where his waist was, at least. That's what it seemed to me. It seems outdoors somehow. Tree.

*Does Hal seem to be looking at that square?*

I don't know. The first impression was that he wasn't, but I have a sense that whatever it was was something one might look at. I don't know if it would be a sign, but something that one might look at.

*Can you tell if it is on the ground or vertical?*

It seemed vertical.

I don't have a sense that it was part of anything particular. It might be on a building or part of a building, but I don't know. There was a tree outside, but I also got the impression of cement. I don't have the impression of very many people or traffic either. I have the sense that he is sort of walking back and forth. I don't have any more explicit picture than that.

*Can you move into where he is standing and try to see what he is looking at?*

I picked up he was touching something—something rough. Maybe warm and rough. Something possibly like cement.

*It is twenty-four minutes after eleven.*

*Can you change your point of view and move above the scene so you can get a bigger picture of what's there?*

I still see some trees and some sort of pavement or something like that. Might be a courtyard. The thing that came to mind was it might be one of the plazas at Stanford campus or something like that, cement.

Some kinds of landscaping.

I said Stanford campus when I started to see some things in White Plaza, but I think that is misleading.

I have the sense that he's not moving around too much. That it's in a small area.

I guess I'll go ahead and say it, but I'm afraid I'm just putting on my impressions from Stanford campus. I had the impression of a fountain. There are two in the plaza, and it seemed that Hal was possibly near the, what they call Mem Claw.

*What is that?*

It's a fountain that looks rather like a claw. It's a black sculpture. And it has benches around it made of cement.

*Are there any buildings at the place you are looking at? Are there any buildings? You described a kind of a courtyard.*

Usually at some places there should be a building, large or small that the courtyard is about. Look at the end or the sides of the courtyard. Is there anything to be seen?

I have a sense that there are buildings. It's not solid buildings. I mean there are some around the periphery and I have a sense that none of them are very tall. Maybe mostly one story, maybe an occasional two story one.

Do you have any better idea of what your square was that you saw at the outset?

No. I could hazard different kinds of guesses.

Does it seem part of this scene?

It . . . I think it could be. It could almost be a bulletin board or something with notices on it maybe.

Or something that people are expected to look at. Maybe a window with things in it that people were expected to look at.

What kind of trees do you see in this place?

I don't know what kind they are. The impression was that they were shade trees and not terribly big. Maybe 12 feet of trunk and then a certain amount of branches above that. So that the branches have maybe a 12 foot diameter, or something. Not real big trees.

New trees rather than old trees?

Yeah, maybe 5 or 10 years old, but not real old ones.

Is there anything interesting about the pavement?

No. It seems to be not terribly new or terribly old. Not very interesting. There seems to be some bits of landscaping around. Little patches of grass around the edges and peripheries. Maybe some flowers. But, not lush.

You saw some benches. Do you want to tell me about them?

Well, that's my unsure feeling about this fountain. There was some kind of benches of cement. Curved benches, it felt like.

They were of rough cement.

What do you think Hal is doing while he is there?

I have a sense that he is looking at things trying to project them. Looking at different things and sort of walking back and forth not covering a whole lot of territory.

Sometimes standing still while he looks around.

I just had the impression of him talking, and I almost sense that it was being recorded or something. I don't know if he has a tape recorder, but if it's not that, then he is saying something because it needed to be remembered. It's 11:33. He's just probably getting ready to come back.

#### ACKNOWLEDGMENT

The authors wish to thank the principal subjects, Mrs. Hella Hammid, Pat Price, and Ingo Swann, who showed patience and forbearance in addition to their enthusiasm and outstanding perceptual abilities. We note with sadness the death of one of our subjects, Mr. Price. We express our sincere thanks also to Earle Jones, Bonnar Cox, and Dr. Arthur Hastings, of SRI, and Mrs. Judith Skutch and Richard Bach, without whose encouragement and support this work could not have taken place.

#### REFERENCES

- [1] J. R. Smythies, Ed., *Science and ESP*. London, England: Routledge, 1967.
- [2] C. Evans, "Parapsychology—What the questionnaire revealed," *New Scientist*, Jan. 25, 1973, p. 209.
- [3] A. Gauld, *The Founders of Psychological Research*. New York: Schocken Books, 1968. See also W. Crookes, *Researches in the Phenomena of Spiritualism*. London, England: J. Burns, 1874.
- [4] R. Targ and H. Puthoff, "Information transmission under conditions of sensory shielding," *Nature*, vol. 252, pp. 602-607, Oct.

- 18, 1974.
- [5] D. D. Home, *Lights and Shadows of Spiritualism*. New York: G. W. Carleton, 1877.
- [6] J. Coover, *Experiments in Psychological Research*. Palo Alto, CA: Stanford Univ. Press, 1917.
- [7] G. Estabrooks, *Bull. Boston Society for Psychological Research*, 1927. See also [12, pp. 18-19].
- [8] L. T. Troland, *Techniques for the Experimental Study of Telepathy and Other Alleged Clairvoyant Processes*. Albany, NY, 1928.
- [9] J. B. Rhine, *New Frontiers of the Mind*. New York: Farrar and Rinehart, 1937.
- [10] J. Pratt and J. B. Rhine et al., *Extra-Sensory Perception after Sixty Years*. New York: Henry Holt, 1940.
- [11] C. Scott, "G. Spencer Brown and probability: A critique," *J. Soc. Psychical Res.*, vol. 39, pp. 217-234, 1958.
- [12] G. R. Price, "Science and the supernatural," *Science*, vol. 122, pp. 359-367, 1955.
- [13] —, "Apology to Rhine and Soal," *Science*, vol. 175, p. 359, 1972.
- [14] J. B. Rhine, "A new case of experimenter unreliability," *J. Parapsychol.*, vol. 38, pp. 215-225, June 1974.
- [15] S. G. Soal and F. Bateman, *Modern Experiments in Telepathy*. London, England: Faber and Faber, 1953.
- [16] C. Scott and P. Haskell, "'Normal' explanation of the Soal-Goldney experiments in extra-sensory perception," *Nature*, vol. 245, pp. 52-54, Sept. 7, 1973.
- [17] C. E. M. Hansel, *ESP—A Scientific Evaluation*. New York: Scribner, 1966.
- [18] J. B. Rhine and J. G. Pratt, "A review of the Pearce-Pratt distance series of ESP tests," *J. Parapsychol.*, vol. 18, pp. 165-177, 1954.
- [19] J. G. Pratt and J. L. Woodruff, "Size of stimulus symbols in extra-sensory perception," *J. Parapsychol.*, vol. 3, pp. 121-158, 1939.
- [20] S. G. Soal and H. T. Bowden, *The Mind Readers: Recent Experiments in Telepathy*. New Haven, CT: Yale Univ. Press, 1954.
- [21] C. Honorton, "Error some place!" *J. Commun.*, vol. 25, no. 1 (Annenberg School of Commun.), Winter 1975.
- [22] M. Ryzl, "Training the psi faculty by hypnosis," *J. Amer. Soc. Psychical Res.*, vol. 41, pp. 234-251, 1962.
- [23] *CIBA Foundation Symposium on Extra Sensory Perception*. Boston, MA: Little, Brown, 1956.
- [24] M. Ryzl and J. Pratt, "A repeated-calling ESP test with sealed cards," *J. Parapsychol.*, vol. 27, pp. 161-174, 1963.
- [25] —, "A further confirmation of stabilized ESP performance in a selected subject," *J. Parapsychol.*, vol. 27, pp. 73-83, 1963.
- [26] J. Pratt, "Preliminary experiments with a 'borrowed' ESP subject," *J. Amer. Soc. Psychical Res.*, vol. 42, pp. 333-345, 1964.
- [27] J. Pratt and J. Blom, "A confirmatory experiment with 'borrowed' outstanding ESP subject," *J. Amer. Soc. Psychical Res.*, vol. 42, pp. 381-388, 1964.
- [28] W. G. Roll and J. G. Pratt, "An ESP test with aluminum targets," *J. Amer. Soc. Psychical Res.*, vol. 62, pp. 381-387, 1968.
- [29] J. Pratt, "A decade of research with a selected ESP subject: An overview and reappraisal of the work with Pavel Stepanek," *Proc. Amer. Soc. Psychical Res.*, vol. 30, 1973.
- [30] C. Shannon and W. Weaver, *The Mathematical Theory of Communication*. Urbana, IL: Univ. Illinois Press, 1949.
- [31] M. Ryzl, "A model for parapsychological communication," *J. Parapsychol.*, vol. 30, pp. 18-31, Mar. 1966.
- [32] C. Tart, "Card guessing tests: Learning paradigm or extinction paradigm," *J. Amer. Soc. Psychical Res.*, vol. 60, p. 46, 1966.
- [33] M. Ullman and S. Krippner, with A. Vaughan, *Dream Telepathy*. New York: Macmillan, 1973.
- [34] C. Honorton, "State of awareness factors in psi activation," *J. Amer. Soc. Psychical Res.*, vol. 68, pp. 246-257, 1974.
- [35] *Proc. 2nd Int. Congr. Psychotronic Research* (Monte Carlo). Cotati, CA: Int. Assoc. Psychotronic Res., 1975.
- [36] L. L. Vasiliev, *Experiments in Mental Suggestion*. Hampshire, England: ISMI Publ., 1963.
- [37] I. M. Kogan, "Is telepathy possible?" *Radio Eng.*, vol. 21, p. 75, Jan. 1966.
- [38] —, "Telepathy, hypotheses and observations," *Radio Eng.*, vol. 22, p. 141, Jan. 1967.
- [39] —, "Information theory analysis of telepathic communication experiments," *Radio Eng.*, vol. 23, p. 122, Mar. 1968.
- [40] —, "The information theory aspect of telepathy," RAND Publ., Santa Monica, CA, p. 4145, July 1969.
- [41] A. S. Presman, *Electromagnetic Fields and Life*. New York: Plenum, 1970.
- [42] Y. A. Kholodov, Ed., *Influence of Magnetic Fields on Biological Objects*, JPRS 63038, NTIS, Springfield, VA, Sept. 24, 1974.
- [43] Y. A. Kholodov, "Investigation of the direct effect of magnetic fields on the central nervous system," in *Proc. 1st Conf. Psychotronic Res.*, JPRS L/5022-1 and 2, Sept. 6, 1974.
- [44] D. Mennie, "Consumer electronics," *IEEE Spectrum*, vol. 12, pp. 34-35, Mar. 1975.
- [45] W. P. Zinchenko, A. N. Leontiev, B. M. Lomov, and A. R. Luria,

- "Parapsychology: Fiction or reality?" *Questions of Philosophy*, vol. 9, pp. 128-136, 1973.
- [46] R. Cavanna, Ed., *Proc. Int. Conf. Methodology in PSI Research*. New York: Parapsychology Foundation, 1970.
- [47] E. D. Dean, "Plethysmograph recordings as ESP responses," *Int. J. Neuropsychiatry*, vol. 2, Sept. 1966.
- [48] C. Tart, "Physiological correlates of psi cognition," *Int. J. Parapsychol.*, no. 4, 1963.
- [49] D. H. Lloyd, "Objective events in the brain correlating with psychic phenomena," *New Horizons*, vol. 1, no. 2, Summer 1973.
- [50] J. Silverman and M. S. Buchsbaum, "Perceptual correlates of consciousness; A conceptual model and its technical implications for psi research," in *Psi Favorable States of Consciousness*, R. Cavanna, Ed. New York: Parapsychology Foundation, pp. 143-169, 1970.
- [51] J. Kamiya, "Comment to Silverman and Buchsbaum," *ibid.*, pp. 158-159.
- [52] D. Hill and G. Parr, *Electroencephalography. A Symposium on Its Various Aspects*. New York: Macmillan, 1963.
- [53] T. D. Duane and T. Behrendt, "Extrasensory electroencephalographic induction between identical twins," *Science*, vol. 150, p. 367, 1965.
- [54] K. Osis, *ASPR Newsletter*, no. 14, 1972.
- [55] R. L. Morris, "An exact method for evaluating preferentially matched free-response material," *J. Amer. Soc. Psychical Res.*, vol. 66, p. 401, Oct. 1972.
- [56] G. R. Schmeidler, "PK effects upon continuously recorded temperatures," *J. Amer. Soc. Psychical Res.*, vol. 67, no. 4, Oct. 1973.
- [57] W. Scherer, "Spontaneity as a factor in ESP," *J. Amer. Soc. Psychical Res.*, vol. 12, pp. 126-147, 1948.
- [58] R. Targ, P. Cole, and H. Puthoff, "Techniques to enhance man/machine communication," SRI, Menlo Park, CA, Final Rep., NASA Contract NAS7-100, June 1974.
- [59] R. Ornstein, *The Nature of Human Consciousness*. San Francisco, CA: Freeman, 1973, ch. 7 and 8.
- [60] R. W. Sperry, "Cerebral organization and behavior," *Science*, vol. 133, pp. 1749-1757, 1961.
- [61] O. Bilaniuk and E. C. G. Sudarshan, "Particles beyond the light barrier," *Phys. Today*, vol. 22, May 5, 1969.
- [62] W. Pauli and C. G. Jung, Eds., *The Interpretation of Nature and the Psyche* (Bollingen Ser. LI). Princeton, NJ: Princeton Univ. Press, 1955.
- [63] M. A. Persinger, "ELF waves and ESP," *New Horizons Trans. Toronto Society for Psychical Research*, vol. 1, no. 5, Jan. 1975.
- [64] —, "The paranormal—P. II: Mechanisms and models," M.S.S. Information Corp., New York, 1974.
- [65] B. Julesz, *Foundations of Cyclopean Perception*. Chicago, IL: Univ. Chicago Press, 1971.
- [66] H. Puthoff and R. Targ, in *Psychic Exploration—A Challenge for Science*, J. White, Ed. New York: Putnam, 1974, pp. 522-542.
- [67] G. Feinberg, "Precognition—A memory of things future?" in *Proc. Conf. Quantum Physics and Parapsychology* (Geneva, Switzerland). New York: Parapsychology Foundation, 1975.
- [68] E. P. Wigner, "The problem of measurement," *Amer. J. Phys.*, vol. 31, no. 1, p. 6, 1963.
- [69] J. J. Freedman and J. F. Clauser, "Experimental test of local hidden variable theories," *Phys. Rev. Lett.*, vol. 28, no. 14, p. 938, Apr. 3, 1972.
- [70] J. F. Clauser and M. A. Horne, "Experimental consequences of objective local theories," *Phys. Rev. D*, vol. 10, no. 2, p. 526, July 15, 1974.
- [71] D. Bohm and B. Hiley, "On the intuitive understanding of non-locality as implied by quantum theory" (Birkbeck College, London, England), Feb. 1974, Preprint.
- [72] J. S. Bell, "On the problem of hidden variables in quantum theory," *Rev. Mod. Phys.*, vol. 38, no. 3, p. 447, July 1966.
- [73] H. Stapp, "Theory of reality," Lawrence-Berkeley Lab. Rep. LBL-3837, Univ. California, Berkeley, Apr. 1975.
- [74] A. Einstein, B. Podolsky, and N. Rosen, "Can quantum-mechanical description of physical reality be considered complete?" *Phys. Rev.*, vol. 47, p. 777, May 15, 1935.
- [75] R. H. Dicke and J. P. Wittke, *Introduction to Quantum Mechanics*. Reading, MA: Addison-Wesley, 1960, ch. 7.
- [76] E. H. Walker, "Foundations of parapsychical and parapsychological phenomena," in *Proc. Conf. Quantum Physics and Parapsychology* (Geneva, Switzerland). New York: Parapsychology Foundation, 1975.
- [77] O. Costa de Beauregard, "Time symmetry and interpretation of quantum mechanics," Lecture delivered at Boston Colloquium for Philosophy of Science (Feb. 1974), *Foundations of Physics* (in press).
- [78] J. A. Stratton, *Electromagnetic Theory*. New York: McGraw-Hill, 1941.
- [79] A. Sinkov, *Elementary Cryptanalysis—A Mathematical Approach*. New York: Random House, 1968.
- [80] P. Hoel, *Introduction to Mathematical Statistics*, 2nd ed. New York: Wiley, 1954, p. 27.
- [81] R. Taetzsch, "Design of a psi communications system," *Int. J. Parapsychol.*, vol. 4, no. 1, p. 35, Winter 1962.

**UNCLASSIFIED**

Appendix C

BIOGRAPHIES OF KEY PERSONNEL

**UNCLASSIFIED**

# UNCLASSIFIED

## RESUME

NAME: Edwin C. May

BRITHDATE: January 11, 1940, Boston, MA

EDUCATION: University of Rochester, Rochester, New York, 1958-1962;  
B.S. Degree, Physics, 1962  
Carnegie Institute of Technology, Pittsburgh, PA, 1962-1964  
University of Pittsburgh, Pittsburgh, PA, 1964-1968;  
Ph.D. Degree, Physics, 1968

EMPLOYMENT: Consultant - Radio Physics Laboratory, SRI International,  
Menlo Park, CA, 1976-present  
Consultant - Maimonides Medical Center, Brooklyn, NY,  
1975-1977  
Physics Instructor - City College of San Francisco,  
San Francisco, CA, 1972-1973  
Voluntary unemployment. Course in artificial intelligence.  
Research efforts at UC-Davis and Stanford Tandem Laboratory,  
September 1971-January 1972  
University of California, Crocker Nuclear Laboratory,  
Davis, CA, 1968-1972

EXPERIENCE: 9 years in nuclear physics involving studies of reaction  
mechanisms and nuclear spectroscopy.  
4 years - three stage tandem Van de Graaff  
3 years - 76 inch, variable energy cyclotron  
1 year - FM cyclotron (450 MeV protons)  
1 year - FN tandem Van de Graaff  
3 years - gamma-ray spectroscopy  
1 year - cardiac blood flow research  
11 years- computer programming both in schematic and assembly  
languages. This includes systems programming, data  
acquisition, data reduction, non-numeric, and  
scientific programming. Computers programmed in  
assembly language include IBM 1401, 7070, 7044,  
7090, 360/50; Xerox Sigma 2,5; DEC PDP 8, 11, 15;  
Nova; CDC 6600; Bendix G-20.  
11 years- Electronics. Mainly solid state fast pulse and  
TTL logic.  
1 year - Data Acquisition Computer study for UC-Davis/AEC.  
1 year - large system computer study for UC-Davis campus.  
3 month - initiated computer system study for CCSF.

5 years - summer employment at the RAND Corp., Santa Monica, Calif. Theoretical calculations in atmospheric physics, radiation transport theory, and E and M wave scattering.

SPECIAL OTHER INTERESTS:

Applications of experimental nuclear physics technology to other fields of interest (i.e., biology, medicine), computer and computer systems, artificial intelligence, teaching physics to non-science students, parapsychological phenomena, trace elemental analysis.

DISSERTATION:

Nuclear Reaction Studies Via the (p, pn) Reaction on Light Nuclei and the (d, pn) Reaction on Medium to Heavy Nuclei, B.L. Cohen, advisor, University of Pittsburgh.



PUBLICATIONS OF EDWIN C. MAY

1. E.C. May and A.B. Kahle, "On the Satellite Determination of High-Altitude Water Vapor," Journal of Geophysical Research, Vol. 69, p. 4141 (1964).
2. E.C. May, B.L. Cohen, and T.M. O'Keefe, "Deuteron Disintegration by Au, Rh, Cu, and C from 8 to 15 MeV," Physical Review, Vol. 164, p. 1253 (1967).
3. B.L. Cohen, E.C. May, and T.M. O'Keefe, "Detection of the Singlet Deuteron ( $\bar{d}$ ) and the  ${}^9\text{Be}(p, \bar{d}){}^8\text{Be}$  Reaction," Physical Review Letters, Vol. 18, p. 962 (1967).
4. B.L. Cohen, E.C. May, T.M. O'Keefe, C.L. Fink, and B. Rosner, "(p, p'n), (p, p'\gamma), and (p, np') Reactions on  ${}^{119}\text{Sn}$  and  ${}^{61}\text{Ni}$ ," Physical Review Letters, Vol. 21, p. 226 (1968).
5. B.L. Cohen, E.C. May, T.M. O'Keefe, and C.L. Fink, "Singlet Deuterons ( $\bar{d}$ ) from (p,  $\bar{d}$ ) Reactions," Physical Review, Vol. 179, p. 962 (1969).
6. J.W. Cline, W.J. Knox, E.C. May and A.H. Sauter, "Proposal to the U.S. Atomic Energy Commission for Procurement of a Computer Implemented Nuclear Data Acquisition and Control System," Crocker Nuclear Lab Report, Number UCD-112 (1969).
7. S.A. Lewis, E.C. May, and J.B. Morrehead, "A Fortran Nuclidic Mass Table with Self-Modification Feature," Nuclear Instruments and Methods, Vol. 87, p. 133 (1970).
8. E.C. May and S.A. Lewis, "The Reaction  ${}^{86}\text{Kr}(d, {}^3\text{He}){}^{85}\text{Br}$ ," Physical Review
9. J.W. Cline, J.A. Jungerman, and E.C. May, "Proposal to the U.S. Atomic Energy Commission for Procurement of a Nuclear Data Acquisition System," Crocker Nuclear Lab Report, Number UDC-CNL 124 (1970).
10. P.D. Bond, E.C. May, and S. Jha, "Coulomb Excitation of  ${}^{99}\text{Tc}$ ," Nuclear Physics
11. S. Jha, N.F. Peek, W.J. Knox, and E.C. May, "Decay of Neutron Deficient Isotopes of Cesium:  ${}^{129}\text{Cs}$ ,  ${}^{127}\text{Cs}$ ," Physical Review C, Vol. 6, p. 2193 (1972).
12. E.C. May, "PSIFI: A Physiological-Coupled, Noise-Driven Random Generator to Extend PK Studies," Research in Parapsychology 1975, p. 20 (The Scarecrow Press, Inc., Metuchen, N.J., 1976).
13. E.C. May, "A Dynamic PK Experiment with Ingo Swann," Research in Parapsychology 1975, p. 88 (The Scarecrow Press, Inc., Metuchen, N.J., 1976).

UNCLASSIFIED

14. C. Honorton and E.C. May, "Volitional Control in a Psychokinetic Task with Auditory and Visual Feedback," Research in Parapsychology 1975, p. 90 (The Scarecrow Press, Inc., Metuchen, N.J., 1976).
15. E.C. May and Isaac Bonewits, "Psychic Bull in India," Psychic, Vol. 7, No. 4, p. 34 (September 1976).
16. E.C. May, R. Targ, and H.E. Puthoff, "Possible EEG Correlates to Remote Stimuli Under Conditions of Sensory Shielding," Proceedings of the IEEE ELECTRO '77 Special Session on the State of the Art in Psychic Research, New York, N.Y. (April 19-21, 1977).
17. R. Targ, H.E. Puthoff and E.C. May, "State of the Art in Remote Viewing Studies at SRI," Proceedings of the 1977 IEEE International Conference on Cybernetics and Society Technical Session on Research in Psychoenergetics, Washington, D.C. (September 20, 1977).

UNCLASSIFIED

UNCLASSIFIED

## MEETING ABSTRACTS

1. E.C. May, B.L. Cohen, and T.M. O'Keefe, "Deuteron Disintegration at 12 MeV," Bulletin of the APS, Vol. 12, p. 37 (1967).
2. E.C. May, B.L. Cohen and T.M. O'Keefe, "Energy Dependence of Deuteron Disintegration," Bulletin of the APS, Vol. 12, p. 521 (1967).
3. B.L. Cohen, E.C. May, and T.M. O'Keefe, "Detection of the Singlet Deuteron ( $\bar{d}$ ) and the  ${}^9\text{Be}(p, \bar{d}){}^8\text{Be}$  Reaction," Post deadline paper (1967).
4. E.C. May, B.L. Cohen, T.M. O'Keefe, and C.L. Fink, "Singlet Deuterons ( $\bar{d}$ ) and the  ${}^7\text{Li}(p, \bar{d}){}^6\text{Li}$  and  ${}^9\text{Be}(p, \bar{d}){}^8\text{Be}$  Reactions," Bulletin of the APS, Vol. 13, p. 83 (1968).
5. B.L. Cohen, E.C. May, T.M. O'Keefe, and C.L. Fink, "Neutron-Proton Coincidence Studies of the  ${}^{119}\text{Sn}(p, pn){}^{118}\text{Sn}$  Reaction," Bulletin of the APS, Vol. 13, p. 657 (1968).
6. S. Gangadharan, E.C. May, M.A. Volkov, and R.L. Wolke, "Recoil Angular Distributions of the  ${}^6\text{Li}(d, n){}^7\text{Be}$  and  ${}^{12}\text{C}(d, n){}^{13}\text{N}$  Reactions," Bulletin of the APS, Vol. 14, No. 37 (1969).
7. E.C. May and S.A. Lewis, "Levels of  ${}^{85}\text{Br}$  via the  ${}^{86}\text{Kr}(d, {}^3\text{He}){}^{85}\text{Br}$  Reaction," Bulletin of the APS, Vol. 15, p. 550 (1970).
8. P.D. Bond, E.C. May, and S. Jha, "Coulomb Excitation of  ${}^{99}\text{Tc}$ ," Bulletin of the APS, Vol. 16, No. 14 (1971).
9. S. Jha, N.F. Peek, E.C. May, Sina Kaviani and S. Abbas, "Decay Scheme of the Neutron-Deficient Odd Cesium Isotopes," Bulletin of the APS, Vol. 15, p. 1669 (1970).
10. E.C. May and M.J. LeVine, "Levels of  ${}^{84}\text{Kr}$  via the  ${}^{86}\text{Kr}(p, t){}^{84}\text{Kr}$  Reactions at 26 MeV," Bulletin of the APS, Vol. 17, p. 50 (1972).
11. N.F. Peek, W.J. Knox, E.C. May, and S. Jha, "The Decay of  ${}^{78}\text{As}$ ," Bulletin of the APS, Vol. 7, p. 16 (1972).
12. S. Jha, N.F. Peek, W.J. Knox, and E.C. May, "Decay of 127, 129Cs," Bulletin of the APS
13. E.C. May, A. Little, P.D. Bond, and S. Jha, "Coulomb Excitation of 127, 129I," Bulletin of the APS, Vol. 18, p. 69 (1973).
14. E.C. May, "Possible Detection of Experimental Instrument with a Selected Subject," Bulletin of the APS, Vol. 21, p. 21 (1976).
15. C. Honorton and E.C. May, "Possible Detection of Experimenter-Instrument Interaction," Bulletin of the APS, Vol. 21, p. 43 (1976).
16. R. Targ, E.H. Puthoff and E.C. May, "EEG Correlates to Remote Stimuli under Conditions of Sensory Shielding," Bulletin of the APS, Vol. 21, p. 1306 (1976).

UNCLASSIFIED

~~UNCLASSIFIED~~

HAROLD E. PUTHOFF, Ph.D.

Radio Physics Laboratory  
SRI International  
Menlo Park, California

Dr. Harold E. Puthoff was born in Chicago, Illinois, on June 20, 1936. His undergraduate and beginning graduate programs were pursued at the University of Florida, Gainesville, Florida, from which he received the Bachelor of Electrical Engineering degree with High Honors in 1958, and the Master of Science in Engineering degree in 1960. While at the University of Florida he received an award for Outstanding Engineering Student, and was awarded memberships in several scholastic and scientific honorary fraternities (Phi Eta Sigma, Phi Kappa Phi, Sigma Tau, and Sigma Xi).

After graduating with a Master's degree from the University of Florida in 1960, he reported to active duty as a commissioned officer in the Navy and was assigned a research billet at NSA, Ft. Meade, MD. While there he pursued research and monitored contracts concerned with the development of ultra-high-speed computers under project LIGHTNING. He also initiated a program to determine the potential of lasers, fiber optics, and other devices of this nature for use in optical and opto-electronic computers. His work in this area resulted in the award of a Department of Defense Certificate of Commendation for Outstanding Performance, and an award of Second Prize for Outstanding Paper of the Year, NSA Technical Journal, 1963. Upon being released from active duty in February 1963, he remained in a civilian status (GS-13) until September 1963, at which time he entered Stanford University to pursue a Ph.D. program.

Following receipt of his Ph.D. degree from Stanford in 1967, he accepted positions as Research Associate at the Microwave Lab and Lecturer in the Department of Electrical Engineering at Stanford, where he pursued teaching and research in lasers and nonlinear optics. While at Stanford, he conceived, patented, and developed a tunable Raman laser which produces high power radiation throughout the infrared portion of the spectrum. He also supervised research for Ph.D. candidates in Electrical Engineering and Applied Physics, published over 25 papers in professional journals on lasers and microwave devices, and published a textbook on lasers (in English, French, and Russian) widely used in universities

UNCLASSIFIED

UNCLASSIFIED

both here and abroad, Fundamentals of Quantum Electronics (Wiley, 1969).

In 1972, he joined the staff of Stanford Research Institute (now SRI International) as a senior researcher where he initiated and is presently engaged in research in quantum physics and parapsychological phenomena.

In the SRI work he has been investigating facets of human perception that appear to fall outside the range of well-understood perceptual/processing capabilities. Of particular interest has been a human information-accessing capability that the SRI team calls "remote viewing." This phenomenon pertains to the ability of certain individuals to access and describe, by means of mental processes, information sources blocked from ordinary perception, and generally accepted as secure against such access. In particular, the phenomenon most extensively investigated is the ability of subjects to view remote geographical locations up to several thousand km distant from their physical location given only geographical coordinates or a known person on whom to target. The remote perceptual abilities of subjects have been developed sufficiently to allow them to describe-- often in great detail--geographical or technical material such as buildings, roads, and natural formations. The accumulated data indicate that both specially selected and unselected persons can be assisted in developing remote perceptual abilities up to a level of useful information transfer. His articles published in Nature (1974) and Proc. IEEE (1976) are the first major articles on the subject of paranormal phenomena to appear in general science journals. He has also co-authored a book Mind-Reach, with an Introduction by Margaret Mead (Delacorte Press, 1977), in which the first five years of research at SRI were brought to the general public, and has in press a co-edited second book of collected technical papers on remote viewing, Mind at Large: Institute of Electrical and Electronic Engineers Symposia on the Nature of Extrasensory Perception (Praeger, 1979).

The general acceptance in the scientific community of his and his colleagues' work at SRI resulted in his being invited to keynote the 1976 IEEE Systems, Man and Cybernetics Society meeting in Washington, D.C., for which he was awarded the IEEE Franklyn V. Taylor Award for the best presentation at the conference; resulted in an invitation to him to

UNCLASSIFIED

**UNCLASSIFIED**

participate in a Special Session on the State of the Art in Psychic Research at the IEEE's national convention in New York City (ELECTRO '77, April 1977); resulted in an invitation to him to keynote the 1977 IEEE Microwave Theory and Techniques national conference in June 1977; and resulted in an invitation to him to chair a session in parapsychology and research at the IEEE Systems, Man and Cybernetics meeting in Washington, D.C., September 1977.

He presently serves in various capacities as consultant and contractor to the DoD and Intelligence Communities in the parapsychological area.

**UNCLASSIFIED**

UNCLASSIFIED

## PUBLICATIONS OF HAROLD E. PUTHOFF

W.W. Peterson and H.E. Puthoff, "A Theoretical Study of Ion Plasma Oscillations," IRE Elect. Dev., Vol. ED-6, p. 372 (1959).

H.E. Puthoff, "Crossed-Field Focusing of a Hollow Cylindrical Electron Beam," U. of Florida M.S. Thesis (January 1960).

A.D. Sutherland, H.F. Renkiewicz, H.E. Puthoff, and D.E. Countiss, "On the Use of Periodic Electrostatic Focusing in Klystrons," presented at the International Congress on Microwave Tubes, Munich, West Germany (June 1960).

H.E. Puthoff, "Design of a Crossed-Field Electron Gun," presented at the Eighteenth Conference on Electron Tube Research, Seattle, Washington (June 1960).

H.E. Puthoff, "Scaling Matrix for the Analog Computer," NSA Tech. Jour., Vol. 7 (1962).

J.T. Tippett and H.E. Puthoff, "The Status of Optical Logic Elements for Nanosecond Computer Systems," Proc. Pacific Computer Conf., Pasadena, California (March 1963). Also published in NSA Tech. Jour., Vol. 8 (1963).

J.T. Tippett and H.E. Puthoff, "Optical Computers Approach Reality," Electronics, Vol. 36, p. 72 (May 1963). Also selected for publication in Optoelectronic Devices and Circuits, ed. by Samuel Weber, p. 266 (McGraw-Hill Book Co., New York, N.Y., 1964).

R.H. Pantell and H.E. Puthoff, "A Proposed Novel Method for Obtaining a Non-Spiking Pulsed Laser," IEEE, Vol. 53, p. 295 (1965).

R.H. Pantell, P. Pheneger, and H.E. Puthoff, "Transient Buildup of Laser Oscillations," presented at Spring Meeting of Electrochemical Society, San Francisco, California (May 1965).

B. Huth, R.H. Pantell and H.E. Puthoff, "Characteristics of a Tunable Raman Laser," presented at Spring Meeting of Electrochemical Society, San Francisco, California (May 1965).

B. Huth, R. Pantell and H. Puthoff, "The Effect of a Static Field on Raman Scattering," presented at 23rd Conference on Electron Device Research, Urbana, Illinois (June 1965).

H.E. Puthoff, R.H. Pantell, and B.G. Huth, "Tunability of the Raman Laser," J. Appl. Phys., Vol. 37, p. 860 (1966).

R.H. Pantell, B.G. Huth, H.E. Puthoff, and R.L. Kohn, "Mode Coupling in an External Raman Resonator," Appl. Phys. Letters, Vol. 9, p. 104 (1966).

B.G. Huth, N.V. Karlov, R.H. Pantell and H.E. Puthoff, "A Study of the Stimulated Raman Effect Using an Off-Axis Resonator," presented at 24th Conference on Electron Device Research, Pasadena, California (June 1966).

UNCLASSIFIED

UNCLASSIFIED

B.G. Huth, N.V. Karlov, R.H. Pantell, and H.E. Puthoff, "Characteristics of the Stimulated Raman Effect in an External Resonator," Proc. Sixth Int. Conf. on Microwave and Optical Generation and Amplification, Cambridge, England (September 1966).

B.G. Huth, N.V. Karlov, R.H. Pantell, and H.E. Puthoff, "A Quantitative Study of the Stimulated Raman Effect Using an Off-Axis Resonator," IEEE Jour. Quant. Elect., Vol. QE-2, p. 763 (December 1966).

R. Pantell, F. Pradere, J. Hanus, and H. Puthoff, "Theoretical and Experimental Values for Two, Three, and Four Photon Absorptions," Jour. Chem. Physics, Vol. 46, p. 3507 (1967).

H.E. Puthoff, R.H. Pantell, B.G. Huth, and M.A. Chacon, "Near-Forward Raman Scattering in  $\text{LiNbO}_3$ ," J. Appl. Phys., Vol. 39, p. 2144 (March 1968).

R.H. Pantell, B.G. Huth, and H.E. Puthoff, "Generation of Nonthreshold Second-Stokes Using an Off-Axis Resonator," IEEE Jour. Quant. Elect. (Corres.), Vol. QE-4, p. 41 (January 1968).

R.H. Pantell, G. Soncini, and H.E. Puthoff, "Stimulated Photon-Electron Scattering," IEEE Jour. Quant. Elect., Vol. QE-4, p. 905 (1968).

J. Gelbwachs, R.H. Pantell, H.E. Puthoff, and J.M. Yarborough, "A Tunable Stimulated Raman Oscillator," Appl. Phys. Letters, Vol. 14, p. 258 (1969).

J.M. Yarborough, S.S. Sussman, H.E. Puthoff, R.H. Pantell and B.C. Johnson, "Efficient Tunable Optical Emission from  $\text{LiNbO}_3$  Without a Resonator," Appl. Phys. Letters, Vol. 15, p. 102 (1969).

S.I. Way, M. Chodorow, and H.E. Puthoff, "Optical Damage in KDP," Appl. Phys. Letters, Vol. 16, No. 4 (1970).

S.S. Sussman, B.C. Johnson, J.M. Yarborough, H.E. Puthoff, R.H. Pantell, and J. Soo Hoo, "A New Source of Tunable Optical and Infrared Radiation," Proc. Polytechnic Inst. of Brooklyn International Symposium on Submillimeter Waves, New York, N.Y. (March 31 to April 2, 1970).

B.C. Johnson, H.E. Puthoff, J. Soo Hoo, and S.S. Sussman, "Power and Linewidth of Tunable Stimulated Far IR Emission in  $\text{LiNbO}_3$ ," Appl. Phys. Letters, Vol. 18, p. 181 (1970).

E. Amzallag, T.S. Chang, B.C. Johnson, R.H. Pantell and H.E. Puthoff, "Stimulated Raman and Polariton Scattering in  $\text{LiIO}_3$ ," J. Appl. Phys., Vol. 42, p. 3251 (1971).

D.L. Hecht, W.L. Bond, R.H. Pantell, and H.E. Puthoff, "Dye Lasers with Ultrafast Transverse Flow," IEEE Jour. Quant. Elect., Vol. QE-8, p. 15 (1972).

H.E. Puthoff and R. Targ, "Experiments with Uri Geller," film for general release, Stanford Research Institute, Menlo Park, California (March 1973).

UNCLASSIFIED



H.E. Puthoff, "Psychoenergetic Research at Stanford Research Institute," presented at 1st International Congress on Parapsychology and Psychotronics, Prague, Czech. (June 1973).

H.E. Puthoff and R. Targ, "PK Experiments with Uri Geller and Ingo Swann," Research in Parapsychology 1973 (Scarecrow Press, Inc., Metuchen, N.J., 1974).

R. Targ and H.E. Puthoff, "ESP Experiments with Uri Geller," Research in Parapsychology 1973, pp. 57-60 (Scarecrow Press, Inc., Metuchen, N.J., 1974).

M.A. Piestrup, R.H. Pantell, H.E. Puthoff, and G.B. Rothbart, "Cerenkov Radiation as a Source of Ultraviolet Radiation," Jour. Appl. Phys., Vol. 44, No. 11, p. 5160 (November 1973).

H.E. Puthoff and R. Targ, "Remote Viewing of Natural Targets," Research in Parapsychology, 1974 (Scarecrow Press, Inc., Metuchen, N.J., 1975).

R. Targ and H. Puthoff, "Remote Viewing of Natural Targets," Proc. 23rd Annual International Conference, Quantum Physics and Parapsychology, Geneva, Switzerland (August 1974).

H.E. Puthoff and R. Targ, "Physics, Entropy, and Psychokinesis," Proc. 23rd Annual International Conference, Quantum Physics and Parapsychology, Geneva, Switzerland (August 1974).

H.E. Puthoff and R. Targ, "Psychic Research and Modern Physics," Psychic Exploration--A Challenge for Science, John White, ed. (G.P. Putnam's Sons, New York, N.Y., p. 524, 1974).

R. Targ and H.E. Puthoff, "Information Transmission Under Conditions of Sensory Shielding," Nature, Vol. 251, p. 602 (October 1974).

R. Targ and H. Puthoff, "Remote Viewing of Natural Targets," Parapsychology Review, Vol. 6, No. 1 (January-February 1975).

H. Puthoff and R. Targ, "Precognitive Remote Viewing," Research in Parapsychology, 1975 (Scarecrow Press, Inc., Metuchen, N.J., 1976).

R. Targ and H. Puthoff, "Replication Study of the Remote Viewing of Natural Targets," Research in Parapsychology, 1975 (Scarecrow Press, Inc., Metuchen, N.J., 1976).

H.E. Puthoff and R. Targ, "A Perceptual Channel for Information Transfer over Kilometer Distances: Historical Perspective and Recent Research," Proc. IEEE, Vol. 64, pp. 329-354 (March 1976).

H.E. Puthoff and R. Targ, "Direct Perception of Remote Geographical Locations," Proc. IEEE ELECTRO '77 Special Session on the State of the Art in Psychic Research, New York, N.Y. (April 19-21, 1977).

UNCLASSIFIED

E.C. May, R. Targ, and H.E. Puthoff, "Possible EEG Correlates to Remote Stimuli Under Conditions of Sensory Shielding," Proceedings of the IEEE ELECTRO '77 Special Session on the State of the Art in Psychic Research, New York, N.Y. (April 19-21, 1977).

R. Targ, H.E. Puthoff and E.C. May, "State of the Art in Remote Viewing Studies at SRI," Proceedings of the 1977 IEEE International Conference on Cybernetics and Society Technical Session on Research in Psychoenergetics, Washington, D.C. (September 20, 1977).

H.E. Puthoff, R. Targ, and E.C. May, "Experimental Psi Research: Implications for Physics," Presented at the 145th National Meeting of the AAAS (American Association for the Advancement of Science), Houston, Texas (January 1979).

H.E. Puthoff and R. Targ, "Information Transmission in Remote Viewing Experiments: II," submitted to Nature.

Books:

R.H. Pantell and H.E. Puthoff, Fundamentals of Quantum Electronics (John Wiley and Sons, Inc., New York, 1969) [English]; (Dunod, Paris, 1973) [French]; (Mir Press, Moscow, 1972) [Russian].

R. Targ and H.E. Puthoff, Mind-Reach (Delacorte Press, New York, N.Y., 1977).

C. Tart, H. Puthoff and R. Targ, Mind at Large: Institute of Electrical and Electronic Engineers Symposia on the Nature of Extrasensory Perception (Praeger Press, New York, N.Y., in press).

UNCLASSIFIED

UNCLASSIFIED

RUSSELL TARG

Senior Research Physicist  
Radio Physics Laboratory  
Electronics and Radio Sciences Division

SPECIALIZED PROFESSIONAL COMPETENCE

- Research in remote sensing and other psychoenergetic phenomena (1972-present).
- Development of high-power gas lasers, FM laser, and supermode laser techniques.
- Optical modulation and demodulation at microwave frequencies.
- Microwave generation from plasmas.

PREVIOUS PROFESSIONAL EXPERIENCE

Sylvania Corporation; investigation of techniques for development of new gas lasers, making use of research with compact, self-contained multikilowatt CO<sub>2</sub> lasers  
Technical Research Group; experiments in new gaseous laser media  
Polytechnic Institute of Brooklyn; assisted in the establishment of Electron Beam Laboratory  
Sperry Gyroscope Company, Electron Tube Division; experimental work in microwave generation from plasmas; early work in the technology of ultrahigh-vacuum and ion-pump design

ACADEMIC BACKGROUND

B.S. in physics (1954), Queens College, New York; graduate work in physics (1954-56), Columbia University

PUBLICATIONS AND INVENTIONS

Author or coauthor of more than thirty articles on lasers and plasma research, and more recently, the first major publication of research on psychoenergetic phenomena in Nature and in the Proceedings of the IEEE: "Information Transfer Under Conditions of Sensory Shielding," Nature (October 18, 1974) and "A Perceptual Channel for Information Transfer over Kilometer Distances," Proc. IEEE (March 1976)  
Coauthor of Mind-Reach: Scientists Look at Psychical Research (Delacorte Press, New York, 1976); Mind at Large: IEEE Symposia on the Nature of Extrasensory Perception (Praeger, New York, 1979)

PROFESSIONAL ASSOCIATIONS

Senior Member IEEE; American Physical Society; President and cofounder of Parapsychology Research Group, a tax-exempt California corporation since 1963, with research and educational objectives in the area of psychic functioning.

UNCLASSIFIED

PUBLICATIONS OF RUSSELL TARG

M. Ettenberg and R. Targ, "Observations of Plasma and Cyclotron Oscillations," Proc. of the Symposium on Electronic Waveguides, Polytechnic Institute of Brooklyn, New York (April 8-10, 1958).

R. Targ and L.P. Levine, "Backward-Wave Oscillations in a System Composed of an Electron Beam and a Hydrogen Gas Plasma," J. of Appl. Phys., Vol. 32, No. 4, pp. 731-737 (April 1961).

P. Rabinowitz, S. Jacobs, R. Targ, and G. Gould, "Heterodyne Detection of Phase-Modulated Light," Proc. IRE, Vol. 50, No. 11 (November 1962).

G. Grosf and R. Targ, "Enhancement in Mercury-Krypton and Xenon-Krypton Gaseous Discharges," Appl. Optics, Vol. 2, No. 3, pp. 299-302 (March 1963).

R. Targ, "Optical Heterodyne Detection of Microwave-Modulated Light," Proc. IEEE (Correspondence), pp. 303-304 (March 1964).

R. Targ, D.E. Caddes, and B.J. McMurtry, "The Traveling-Wave Phototube. Part II: Experimental Analysis," IEEE Trans. on Electron Devices, Vol. ED-11, pp. 164-170 (April 1964).

S.E. Harris and R. Targ, "FM Oscillation of the He-Ne Laser," App. Phys. Letters, Vol. 5, No. 10, pp. 202-204 (15 November 1964).

R. Targ, G.A. Massey, and S.E. Harris, "Laser Frequency Translation by Means of Electro-Optic Coupling Control," Proc. IEEE (Correspondence), Vol. 52, No. 10, pp. 1247-1248 (October 1964).

R. Targ and W.D. Bush, "Automatic Frequency Control of a Laser Local Oscillator for the Heterodyne Detection of Microwave-Modulated Light," Appl. Optics, Vol. 4, No. 11, pp. 523-527 (December 1965).

G.A. Massey, M.K. Oshman, and R. Targ, "Generation of Single-Frequency Light Using the FM Laser," Appl. Phys. Letters, Vol. 6, No. 1, pp. 10-11 (January 1965).

L.M. Osterink and R. Targ, "Single-Frequency Light from an Argon FM Laser," Appl. Phys. Letters, Vol. 10, No. 4, pp. 115-117 (February 1967).

R. Targ and J.M. French, "Stabilization of a He-Ne Laser," Proc. IEEE, Vol. 55, No. 7, pp. 1185-1192 (July 1967).

L.M. Osterink and R. Targ, "Single-Frequency Light Using the Super-Mode Technique with an Argon FM Laser," Proc. of the Symposium on Modern Optics, Polytechnic Institute of Brooklyn, New York (March 22-24, 1967).

R. Targ and L.M. Osterink, "Frequency Stabilization and Quieting of the FM Laser," 1967 WESCON Convention Record, San Francisco, California (1967).

R. Targ and J.M. Yarborough, "Mode-Locked Quieting of the He-Ne and Argon Lasers," Appl. Phys. Letters, Vol. 12, No. 1, pp. 3-4 (1 January 1968).

D.E. Caddes, L.M. Osterink, and R. Targ, "Mode-Locking of the CO<sub>2</sub> Laser," Appl. Phys. Letters, Vol. 12, No. 3, pp. 74-76 (1 February 1968).

R. Targ, J.M. Yarborough, and J.M. French, "Frequency Stabilization and Noise Suppression in the Argon FM Laser," IEEE J. of Quant. Elect., Vol. QE-4, pp. 644-648 (October 1968).

W.B. Tiffany, R. Targ, and J.D. Foster, "Kilowatt CO<sub>2</sub> Gas-Transport Laser," Appl. Phys. Letters, Vol. 15, No. 3 (1969).

W.B. Tiffany, and R. Targ, "The Gas-Transport Laser--A New Class of High-Power Electro-Optic Devices," Laser Focus, pp. 48-50 (September 1969).

R. Targ and W.B. Tiffany, "Gain and Saturation in Transverse Flowing CO<sub>2</sub>-N<sub>2</sub>-He Mixtures," Appl. Phys. Letters, Vol. 15, No. 9 (1 November 1969).

S.E. Schwarz, T.A. deTemple, and R. Targ, "High Pressure Pulsed Xenon Laser," Appl. Phys. Letters, Vol. 17, No. 7 (1 October 1970).

J.D. Taynai, R. Targ, and W.B. Tiffany, "An Investigation of Tellurium for Frequency Doubling with CO<sub>2</sub> Lasers," IEEE J. of Quant. Elect., Vol. QE-7 (8 August 1971).

R. Targ and M.W. Sasnett, "High Repetition Rate Xenon Laser with Transverse Excitation," IEEE J. of Quant. Elect., Vol. QE-8, pp. 166-169 (February 1972).

R. Targ and M.W. Sasnett, "Xenon-Helium Laser at High Pressure and High Repetition Rate," Appl. Phys. Letters, Vol. 19, No. 12 (15 December 1971).

R. Targ, "Pulsed Nitrogen Laser at High Repetition Rate," IEEE J. of Quant. Elect., Vol. QE-8, pp. 726-728 (August 1972).

R. Targ and D. Hurt, "Learning Clairvoyance and Precognition with an Extra-sensory Perception Teaching Machine," Parapsychology Review, pp. 9-11 (July 1972).

T.S. Fahlen and R. Targ, "High-Average-Power Xenon Laser," IEEE Journal of Quantum Electronics, Vol. QE-9, No. 6 (1973).

H.E. Puthoff and R. Targ, "Physics, Entropy, and Psychokinesis," 23rd Intl. Conf., Quantum Physics and Parapsychology, Geneva (1974).

R. Targ and H. Puthoff, "Remote Viewing of Natural Targets," Proc. 23rd Intl. Conference, Quantum Physics and Parapsychology, Geneva (1974).

H.E. Puthoff and R. Targ, "Psychic Research and Modern Physics," Psychic Exploration--A Challenge to Science, John White, Ed. (Putnam and Sons, N.Y., 1974).

R. Targ and H. Puthoff, "Information Transmission Under Conditions of Sensory Shielding," Nature, Vol. 251 (1974).

H. E. Puthoff and R. Targ, "A Perceptual Channel for Information Transfer Over Kilometer Distances: Historical Perspective and Recent Research," Proceedings of the IEEE, Vol. 64, No. 3, pp. 329-354 (March 1976).

R. Targ and H. E. Puthoff, Mind Reach: Scientists Look at Psychical Research (Delacorte Press, New York, N.Y., 1977).

H. E. Puthoff and R. Targ, "Direct Perception of Remote Geographical Locations," Proceedings of the IEEE ELECTRO '77 Special Session on The State of the Art in Psychic Research, New York, N.Y., April 19-21, 1977.

E. C. May, R. Targ, and H. E. Puthoff, "Possible EEG Correlates to Remote Stimuli Under Conditions of Sensory Shielding," Proceedings of the IEEE ELECTRO '77 Special Session on the State of the Art in Psychic Research, New York, N.Y., April 19-21, 1977.

R. Targ, H. E. Puthoff and E. C. May, "State of the Art in Remote Viewing Studies at SRI," Proceedings of the 1977 IEEE International Conference on Cybernetics and Society Technical Session on Research in Psychoenergetics, Washington, D.C., September 20, 1977.

C. Tart, H. Puthoff, and R. Targ, Mind at Large: Institute of Electrical and Electronic Engineers Symposia on the Nature of Extrasensory Perception (Praeger Press, New York, N.Y., in press).

H.E. Puthoff, R. Targ, and E.C. May, "Experimental Psi Research: Implications for Physics," presented at the 145th National Meeting of the AAAS (American Association for the Advancement of Science), Houston, Texas (January 1979).

H.E. Puthoff and R. Targ, "Information Transmission in Remote Viewing Experiments: II," submitted to Nature.

**SECRET**

WARNING NOTICE - Intelligence Sources  
and Methods Involved

**SECRET**