

TOM
5 Jul 84
1019

33° 51' 6" N
35° 30' 25" E

A flat
solid
B land

33° 51' 6" N
35° 30' 25" E

M Break

33° 51' 6" N
35° 30' 25" W

A sloping 40
angle
flat
M Break
B -

33° 51' 6" N
35° 30' 25" E

A solid
manmade
sloping
B -

S-2
solid
hard
large

This document is made available through the declassification efforts
and research of John Greenewald, Jr., creator of:

The Black Vault



The Black Vault is the largest online Freedom of Information Act (FOIA)
document clearinghouse in the world. The research efforts here are
responsible for the declassification of hundreds of thousands of pages
released by the U.S. Government & Military.

Discover the Truth at: <http://www.theblackvault.com>

S-2 C
patterned
manned
sloping

AI Break
strange

Aol Break
Wall on
pyramid

S-2 D AI EI T I AOL AOL/SIG

rising
sloping

patterned

large

AI Break
strange

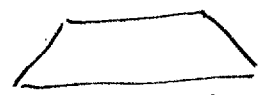
Aol Break

defence system
around
Moscow

green

broad

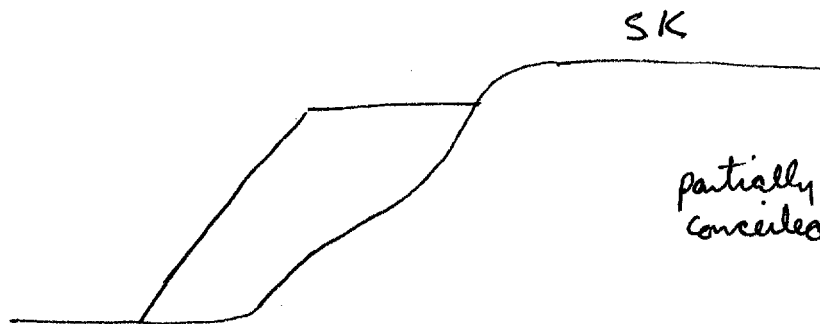
flat-
sloping



partially
concealed

structure

S-2

D

AI

EI

T

I

AOL

AOL/S14

large
broad
solid
sloping
raised

structure

sloping

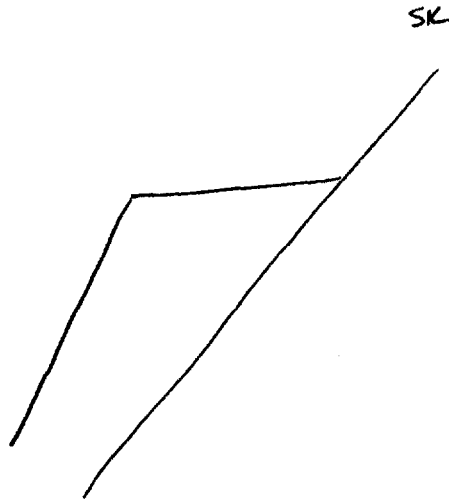

manned

land

interface
manned
and
land

underground
section

Aol Beach
missile
silo

Aol Beach
Egyptian
feeling

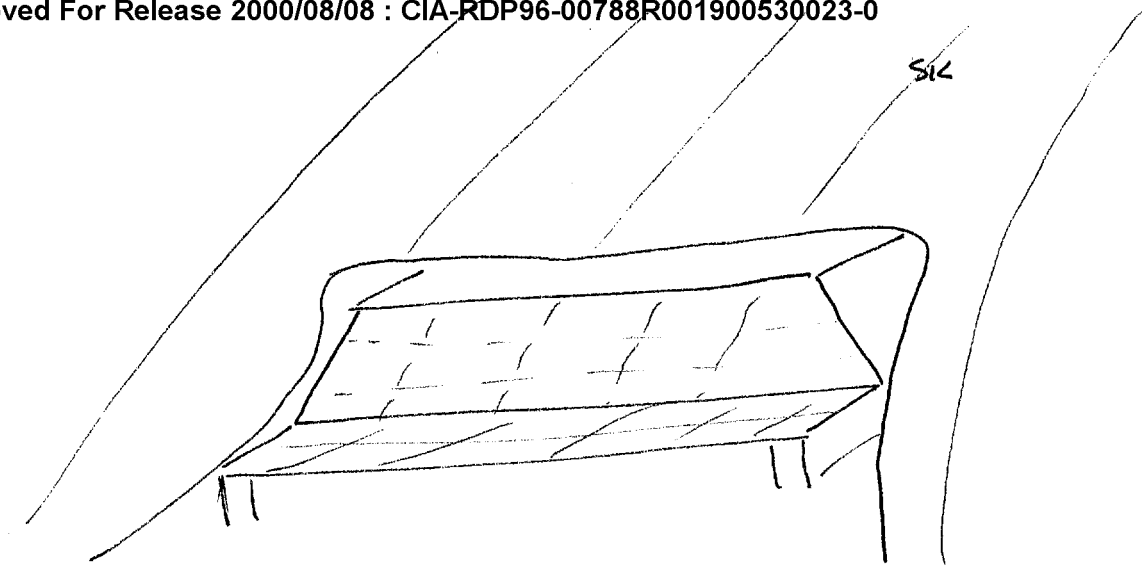

S-Z D AI EI T I AOL AOL/SIG

secure solid controlled secure important

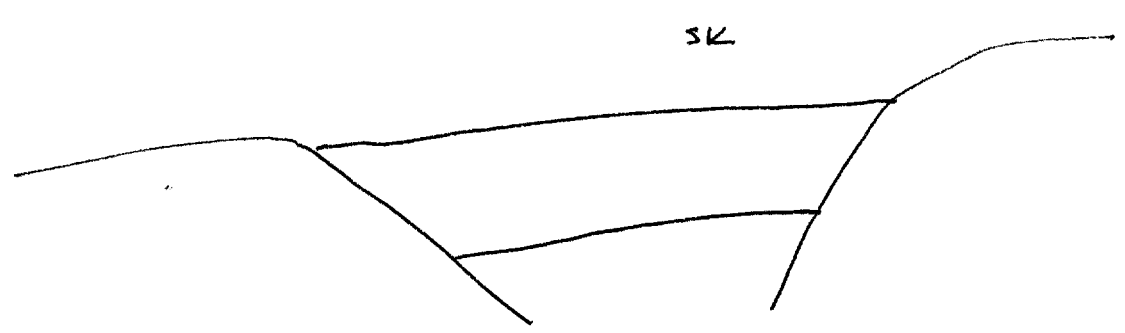

Aol Break
Dam

Aol Break
Bridge



A sloping up
Conf Break

33° 51' 6" N
35° 30' 25" W

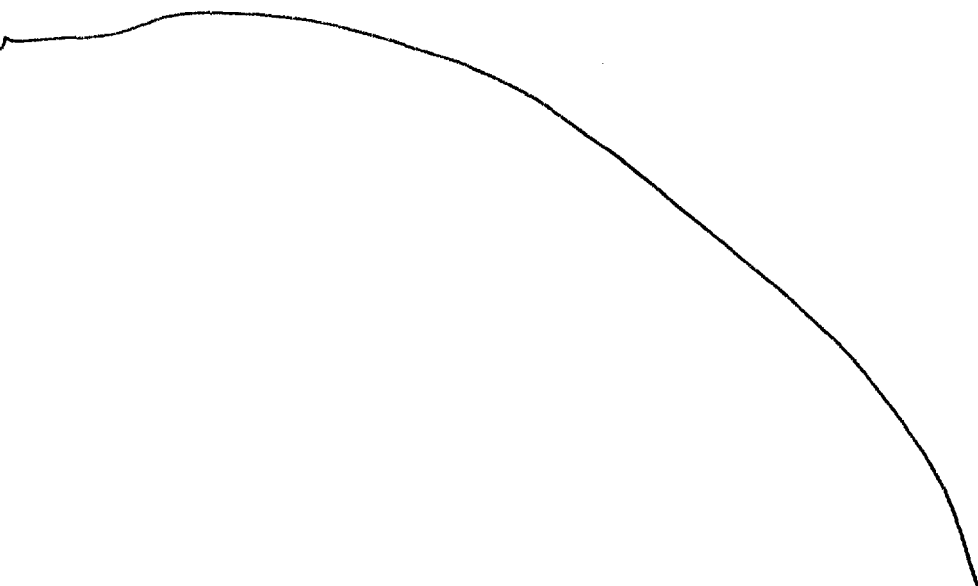

A. curius
long
nonmade

B-

sz large
long
white
solid
gray
irregular
curving

35° 51' 6" N
35° 30' 2" Conf Beach

33° 51' 6" N
35° 30' 25" W

Beach



A flat angle
flat
manmade
B -

A. Curving
manmade
B -

AOL Beach
Roads

S-2 D AI EI T I AOL AOL/SIG

Curving

white

hard

flat

flat

textured

green

Roads

smells

manmade

smells

sounds

loud sounds

Aol Beach
Airport

33° 51' 6" N
35° 30' 25" W



A rising manmade
flat angles

B — structure

A solid
manmade
rising

B -

SK



S-2

D

AI

EI

T

I

AOL

AOL/SIG

rising
curving

white
gray
angles

angles

road
structures

SK

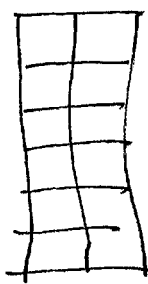

rising

Building

AJ Bush
strange

strange

0

recessed
sections
squares

dark

people
people

many

people

loud
noisy
noisy

hatched
Bustle

S-2

D

AI

ET

T

J

AOL AOL/SIG

with
wounded
impresent

several
floors

trapped

TM Break

AOL Break
people in
pens

Conf Break

people
in
pens
prison

AI Break
heavy tubes

heavy m's
concern
worry

AOL Break
human
experimentation

People trapped or being
held there

End

torn
5 July 84
10.19

33° 51' 6" N
35° 30' 25" E

I

A flat
solid
B land

"

I

A
m Breaks

"

I

A sloping
up
angle
flat
m Breaks
B -

"

I

A solid
manacle
sloping

3 -

S-2 solid
hard
Textured
large
patterned
Manmade
sloping

AI Break strange

Real Break
Wall or
Pyramidal

S-2	D	AI	ET	T	F	Real	AI S
patterned	rising sloping large						

AI Break
strange

Real Break
long pyramidal
def. corner
Moscow

SK

Partially
concealed

green
broad
flat sloping

structure

AI Break
awesome

S2 D AI EI T I Dev A/S

large
road

solid sloping

sloping
raised

structure

SK

mamade

land
Interface
mamade & land
underground
section

Aal Break
Missile
silo

Aal Break
Egyptian

SK

solid
controlled

secure
controls
Important

SK

Aal Break
Dam

S2

0

A1

E1

T

I

(4)

Bad AS
Bad Breaks
Bridge

I

Asbestos
up

B

Conf Breaks

33° 51' 6" N

35° 30' 25" E

I

A cums.
long
Mamade

B -

S-2 large
long
white
solid
grey
irregular
cunning.

"

Conf Breaks

~~Short~~

Miswrite

Break

33° 51' 6" N

35° 30' 25" E

I

A

I

A flat angle
B flat manacle

A curing manacle

B -

S.2

Real Breaks swads.

S2

D

A I

Σ I

T

I

Real A/S

Curing

flat

white
hard
flat
textured
green
smells

swads

S.2 D AI EI T F Ad AS

Manned
smells
sounds
loud
sounds

Ad Break
Report

33° 51' 6" N

35° 30' 25" E

9

A rising
manned
flat
angles

B structure

A solid
manned
rising

B -

S/K

S2 D AI EI T I Hal A/S

rising
curving

white
grey
angles

angles
roads
structure

S/D

rising

Buildings

AI Break
Strans

strange

recessed
sections

squares

people

dots

many

loud noises

noisy

people

hustle &
Bustle
recessed
crowded
unpleasant

several
floors.

trapped

TM Break

S.2 D AI EI T † Dal A/S

Dal Breaks
people in

people in
pens.
prison

← AI Breaks
heavy vikes
concern
worry

Dal Breaks
Human
exp.

lot of people
trapped + being
held there.

Encl.

33° 51' 06" N

35° 30' 25" E

FOR INFO TO RUN TOM