

9 Nov 87

SECRET/NOFORN - SKEET CHANNELS ONLY

PROJECT SUN STREAK (U)

WARNING NOTICE: INTELLIGENCE SOURCES AND METHODS INVOLVED

Session Procedures Report (S/NF/SK)

PROJECT NUMBER: 8719	SESSION NUMBER: 1
DATE OF SESSION: 5 NOV 87	TARGET COUNTRY: IRAN
REFERENCE:	MISSION STATUS:
TECHNIQUE UTILIZED: CRV	SOURCE IDENTIFIER: 011

1. (S/NF/SK) Monitor Tasking: (See tasking cover sheet, attached).
2. (S/NF/SK) Source Tasking: Encrypted target coordinates only.
3. (S/NF/SK) Summary: No summary was requested of 011; the target was acquired in Stage 1 but, upon moving [inside] the structure, the tenor of the information began to change--011 seemed to have lost the target and, although Stage 3 movement exercises continued to land 011 back on the site, the perceptions of the structure's [inside] did not corroborate known site-related data. Both 011 and the monitor (later) agreed that there seems to be an area of archeological interest beneath the target structure, an area which held great attraction to 011 throughout most of the session.
4. (S/NF/SK) Comments: Having identified the problem, 011 should have no problem addressing the EEI in session #2.

SG1J

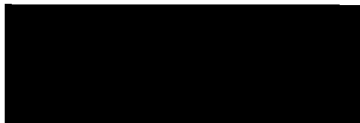

CPT, USA

SECRET/NOFORN - SKEET CHANNELS ONLY

CLASSIFIED BY: DIA-DT
DECLASSIFY : OADR

This document is made available through the declassification efforts
and research of John Greenwald, Jr., creator of:

The Black Vault



The Black Vault is the largest online Freedom of Information Act (FOIA) document clearinghouse in the world. The research efforts here are responsible for the declassification of hundreds of thousands of pages released by the U.S. Government & Military.

Discover the Truth at: <http://www.theblackvault.com>

SG1A

Approved For Release 2000/08/08 : CIA-RDP96-00789R000200240002-2

Approved For Release 2000/08/08 : CIA-RDP96-00789R000200240002-2

681001
187811

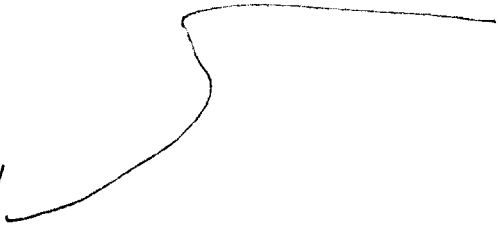

to incline up, vert up
angle across
hard
E structure

681007
187814

to water up, currents
over, across, flat
hard
to land

681007
18781L



A - across, angle up,
angle across, very
flat
hard

B. structure

S-2?

brown
reddish brown
~~earthen~~
green
brown
reddish brown
earthen
roundness
curving
sandy
gritty
loose

40L broab
like sand or
dirt

S-2

A/S

INSIDE?

purplish red
dark

shadowy

curving
arched
angle
pointed



red
yellow
hard
rough
chalky

Stone-like

grey

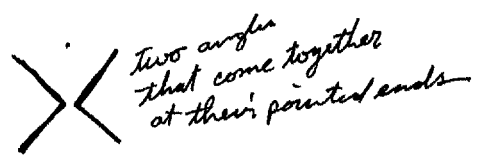

ROOM

grey
light blue

large
empty
arched

room

INSIDE?

square
rectangle
incline

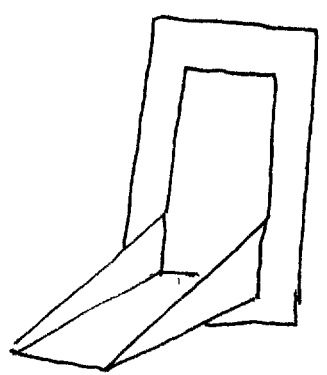

ramp

door break
like a castle
drawbridge

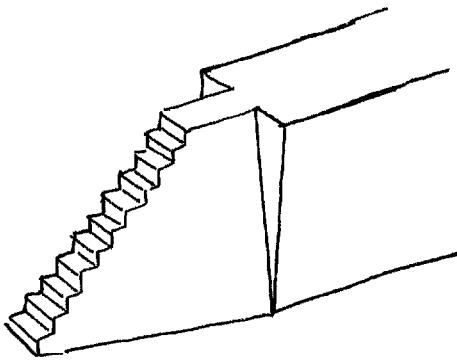

large
rectangular
flat

platform-like
stairs

dark
rough

ACTIVITY?

person

4 1/2 - person hurrying up tall, steep staircase.... stop him and
he has no time, but points down this long staircase.... follow down the
staircase..... large, open, empty area.... feeling of water at the bottom

from safety something should be used



← across, curving around,
loop, curving around,
loop.

STRUCTURE
INSIDE?

green
rectangle
liquid
transparent
green

tank

AOZ break
like an aquarium
filled with antifreeze

curve
curving
straight
round

large
open
spacious

1/2 - get the feeling that I'm down under - like in a basement
or something.

dark
dark
misty
dusty

storage
forgotten objects
lack of activity
lost objects

AOZ break
like the basement of
an old museum

AOZ break
feel like I'm looking
for the lost Ark

INSIDE?

light
yellow

open
airy
straight lines
angles
square
rectangles

lots of natural light

lots of glass

Asl break
like a modern
airport

TANGIBLE!

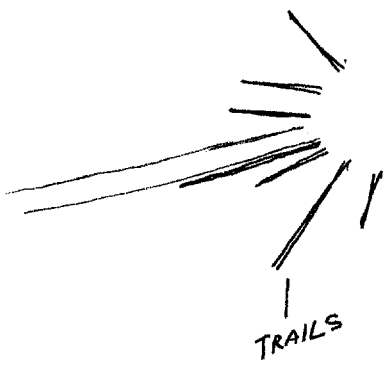

lots of trails

S-2:

D

AI

EI

TANK

I

AOI

A/C

11.

Approved For Release 2000/08/08 : CIA-RDP96-00789R000200240002-2

ACTIVITY?



large

buildings

airfield

aircraft

AOI/S

RAMESKOYA
USSR