

1

*Ch...  
M...*

*[Handwritten signature]*

~~SECRET~~/NOFORN - SKEET CHANNELS ONLY

PROJECT SUN STREAK (U)

CRV SESSION PROCEDURES REPORT

WARNING NOTICE: INTELLIGENCE SOURCES AND METHODS INVOLVED

CONTROL NUMBER: 8709	NICKNAME: None
DATE OF SESSION: 12 Aug 87	TARGET COUNTRY: UR
REFERENCES: None	SESSION NUMBER: 01
DATE OF REPORT: 14 Aug 87	MISSION STATUS: Continuing
TECHNIQUE UTILIZED: CRV	SOURCE IDENTIFIER: <del>001</del> 003

1. (S/NF/SK) INTERVIEWER TASKING: This project has several levels of tasking. Each separate level will be addressed as it occurs in the sessions or as the specific data obtained from the session answers in part or whole any of the tasking provided. The initial tasking being exploited in this session pertains to the configuration and special characteristics of the US developed "Stealth" bomber. Future sessions will be devoted to comparing this aircraft with prototype Soviet systems as well as seeking out the method by which the Soviet Union was able to acquire US Stealth technology.

2. (S/NF/SK) SOURCE TASKING: Source was told only that this is the first session of a multi-session target and that He had not previously been targeted against this tasking. Source was further provided encrypted coordinates of 135750~~0~~/112794, as per Coordinate Remote Viewing (CRV) protocols, and directed to begin with the general area of the target site and move to the specifics at the direction of the Interviewer.

3. (S/NF/SK) INCLEMENCIES: There were no reportable incidents or anomalies which may have influenced the data obtained in this session. It should be noted that this session constituted the initial session under an office re-organization in which this Source was placed under the operational supervision of the Interviewer. The changing of "rhythms" and interpersonal relationships between the Source and the Interviewer often results in some early faltering but as these relationships become firmed up the problems seem to fade and disappear.

4. (S/NF/SK) SUMMARY: Source furnished the attached summary which was prepared following the session and submitted to the Interviewer

*Conclude  
[Handwritten notes]*

This document is made available through the declassification efforts  
and research of John Greenewald, Jr., creator of:

# The Black Vault



The Black Vault is the largest online Freedom of Information Act (FOIA) document clearinghouse in the world. The research efforts here are responsible for the declassification of hundreds of thousands of pages released by the U.S. Government & Military.

**Discover the Truth** at: <http://www.theblackvault.com>

██████████ /NOFORN - SKEET CHANNELS ONLY

within 36 hours after the session. The completeness of the typewritten summary has been compared to the Interviewer's notes and all deletions, changes, and/or corrections have been verified as acceptable by the Interviewer. In the summary Source reported a warm, dry area with a decided military "feel" about it. According to Source there may have been a body of salt water near this area. The site seems to be concerning with the development or use of some sort of high-technology equipment which Source alternately perceived as land based tracked vehicles to surface to air missile systems. The site is made up of a complex of separate areas reminding Him of military bivouac sites and tactical operations centers. Some of the equipment in this area is routinely kept concealed with tarps and transported to the area on large flat bed trucks. Source touched briefly on several items of "special interest" but was unable to objectify these objects in a manner which would indicate that He had in fact acquired the proper site nor item of interest.

5. (S/NF/SK) COMMENTS: This was the initial session between Source and this Interviewer in an official team relationship. In the opinion of the Interviewer, Source may have been suffering from a residual "drive" from the last project which dealt with the mid-East. It could be argued that He was, in fact, on target, if one presumes that the Stealth technology is being tested and developed in an arid region such as the Mojave Desert or other areas of the US Southwest and that the descriptions of the bivouac areas was nothing more than His impressions of the test area. This is a moot point however, since the main thrust of the targeting is the actual aircraft and at no time during the session was the Source able to provide data which would indicate that He was attempting to describe an airframe or items associated with an aircraft. His description of a rather complicated component, which he was directed to "re-sketch" may, on the other hand, be a description of a key component of the Stealth system and representative of Source's impression of what the main characteristic of that aircraft. Future sessions will be dedicated to directing Source's focus of attention to the "item of interest to this tasking" in the hopes that He will be able to throw off any other ADL and begin describing the actual aircraft.

agree!  
to see

SG1J



GS-13, DAC  
Interviewer

Site involves a land/structure/water interface as well as an activity or event. Land is arid, sandy, unsettled; water is large, bounded by land on at least two sides, may be salt; climate is sunny, warm, and bright. At least one of the structures in the general area seems to be grey, large, complex, made of metal, and suggestive of the AOL of 'vessel'. Military, organized, assigned, watching, and waiting are words that apply to this structure. There is also a chronic, low-grade tension present. People present are wearing clothing "like" uniforms, but they are not all the same.

Another facet of the site involves an area on land, isolated, which includes vehicles, trailers, antennas, cables, etc. parked in a way suggestive of a TOC or bivouac site. This grouping of ~~vehicles, etc.~~ serves a supporting function for some other part of a "system" which seems to be weapons related in some way. This first "bivouac area" seems presently to be dormant, or "on standby", with low manning level. It's "like" a C<sup>3</sup> site; it involves electronics but they are not primary to its function. There are occasional aircraft overhead, not threatening, but like they're patrolling or something similar. This location, together with the other location that is connected with it, are combat related, have a purpose that is directly connected with weapons and targeting, and is somewhat mobile. Tracked vehicles are present, along with one that seems to be used for transporting and placing into operation one form of weapons system that involves long cylindrical objects mounted in multiples which can be individually dismounted and remounted. AOL of SAM-6.

There is a further object of interest which may or may not be hidden from view. It doesn't seem especially complex, but is based on relatively simple principles. A container is involved. The object is rounded, angled, curved, somewhat dense in part of it, has components that are interconnected it doesn't seem to be especially large. Something within the object can be rotated. It clicks as it goes, "like" octagonal or hexagonal. There are things resembling small tubes, pipes, or conduits coming out and going in. Some sort of housing is involved.

A further item of possible interest is secured and wrapped in a flexible covering like a very large tarp and carried on a flat-bed trailer; it must be lifted off with a crane cautiously to avoid damage or "decalibration."

*Two other  
vehicles  
"did" remain  
+ some things.*

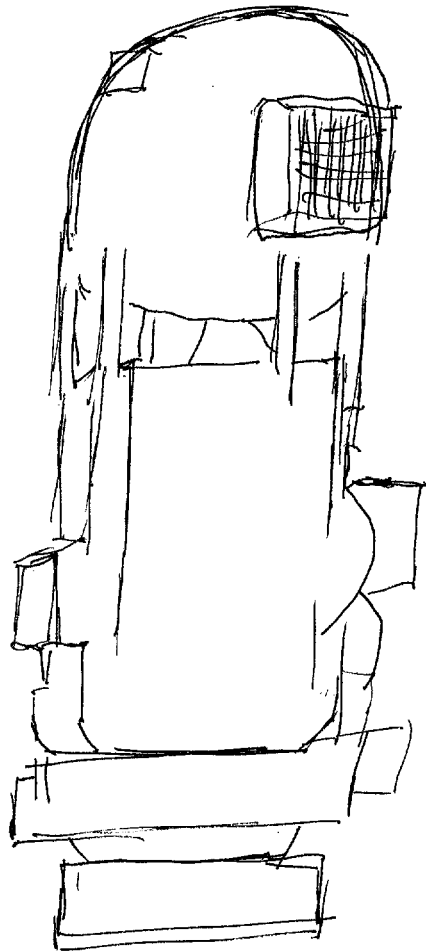

Object from  
Page 17  
12 Aug 87 session  
PHS

12 Aug 87

1300 hrs

P.S.

SESSION # 1

PROJECT 8709

①

112794

→ PAUL, THIS IS A NEW PROJECT. IT CONTAINS MULTIPLE TASKINGS BUT WE WILL TRY TO GUIDE YOU THROUGH ONLY ONE TASKING AT A TIME. THERE ARE SOME VERY SPECIFIC ITEMS IN THE TASKING WHICH MUST BE ADDRESSED SO YOU MAY FEEL AT TIMES THAT I AM "POKING" AT YOU. BEAR WITH ME AND BE VERY CAREFUL OF AOL, ~~AOL~~ AOL DRIVE AND PEACOCKING."

★ OKAY, ARE YOU GOING TO BE MY MONITOR NOW ✓

→ YES - 137500/112794

→ SPEAK UP JUST A LITTLE

→ PAUL, I BELIEVE YOU MAY BE IN THE RIGHT GEOGRAPHIC AREA BUT YOU HAVE NOT BEGUN TO ADDRESS THE ACTUAL TARGETING. TRY TO FOCUS NOW ON THE ACTUAL TARGETS.

→ STOP. YOU JUST FINISHED A PAGE ~~IN~~ IN STAGE IV AND THEN WENT BACK AND WROTE STAGE VI ON THE TOP - START A NEW SHEET

✓ ★ YOU'RE TOO PICKY

→ SPEAK UP

→ BEFORE WE MOVE TOO FAR AWAY, I WOULD LIKE YOU TO SPEND A LITTLE MORE TIME WITH THE PHYSICAL ITEMS YOU REFERENCED EARLIER IN STAGE II, III AND STAGE IV -

★ I FEEL LIKE I'M IN A DIFFERENT PLACE NOW

→ THIS BINOVAC/C3) TOC ETC ARE ~~THESE~~ PROBABLY THERE - THEY ARE IN SUPPORT OF <sup>THE MAJOR</sup> ~~ANOTHER~~ ASPECT OF THIS TASKING -

→ MOVE AWAY FROM THAT VEHICLE. YOU SPOKE OF A LONG, HARD, ONWOOD OBJECT. LET'S MOVE BACK TO THAT

(2)

- You may be keyholing the components but I need the entire target. Draw your focus back a bit to see if you can give me a larger gestalt.
- Draw an area - locate the items you have described. How to locate the other object of special interest.
- ★ It's the thing I described before, the round thing with the cover.
- That may be interesting to you but I think you're mixing psychic metaphors - so locate the object shielded from view that interest me.
- ★ Everyone here would be interested in this object. Look onto that interest and describe it to me.
- ★ Do you know what it looks like
- Yes

Paul  
12 Aug 84  
F7 needs me  
Gene  
1304

137500

112794

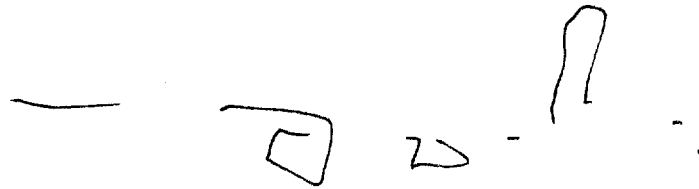

A.

A7 BK Chilly

137500

112794

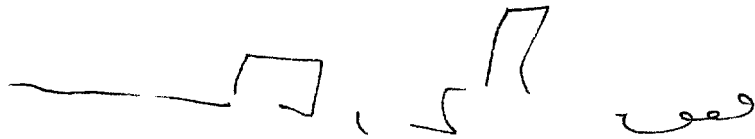

A. over  
flat  
was

A. over  
waves  
fluid

B. units

drawn  
wound  
up over  
ought down

Sol. 2

B. Structures

A. over  
waves  
Sol. 2

B. Structures  
went



grey  
hard  
sweaty  
bumpy  
bed  
black  
wispy  
bright  
blue  
grey  
white

open  
wood  
faded  
solid  
large

A2 Bk  
excitement  
abstract

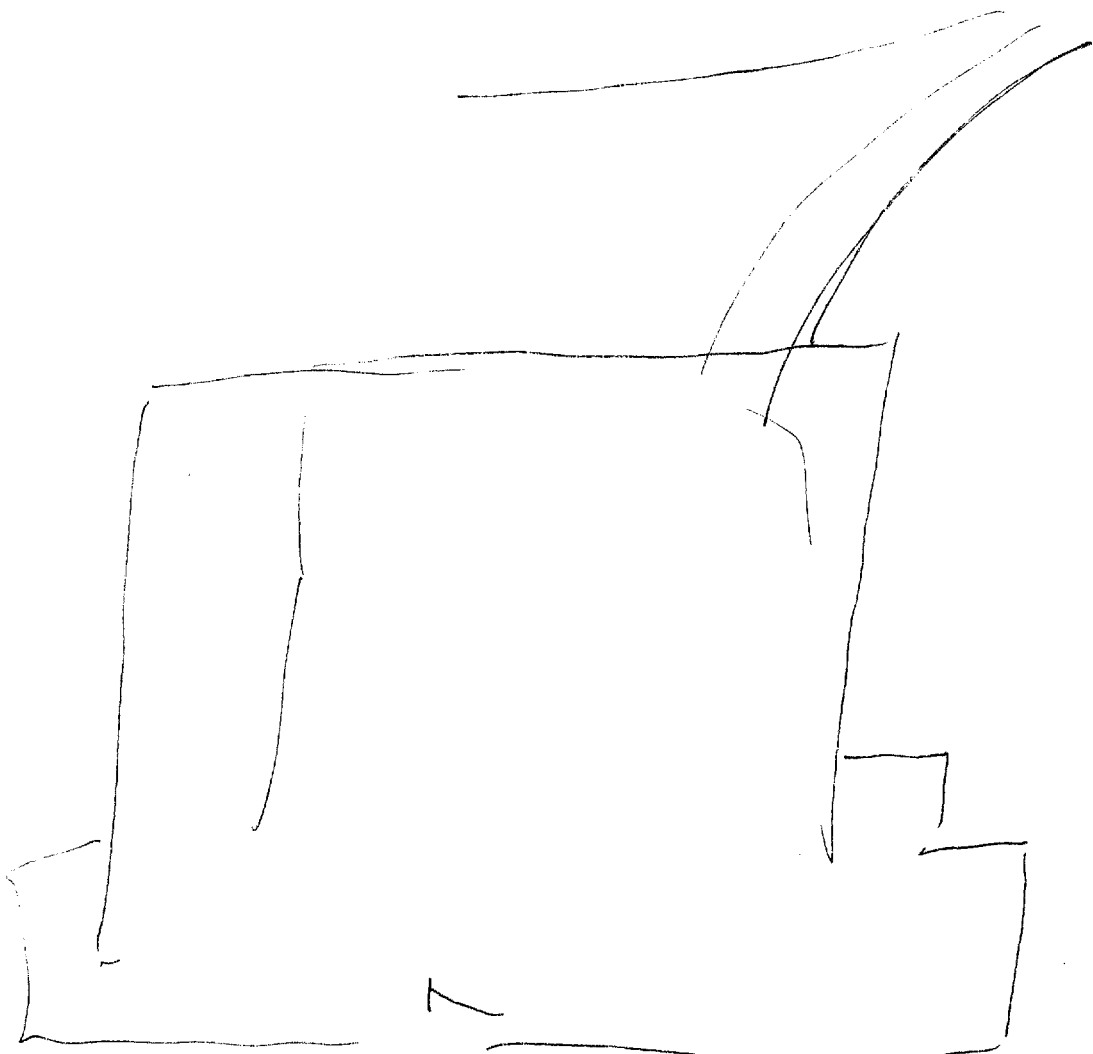
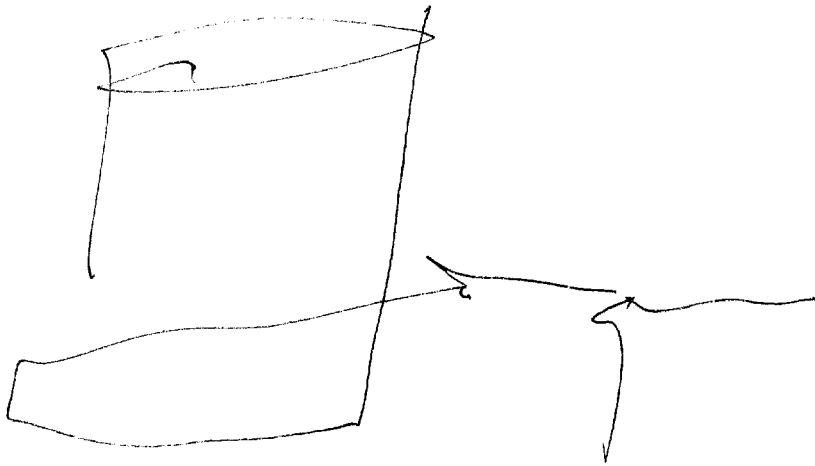

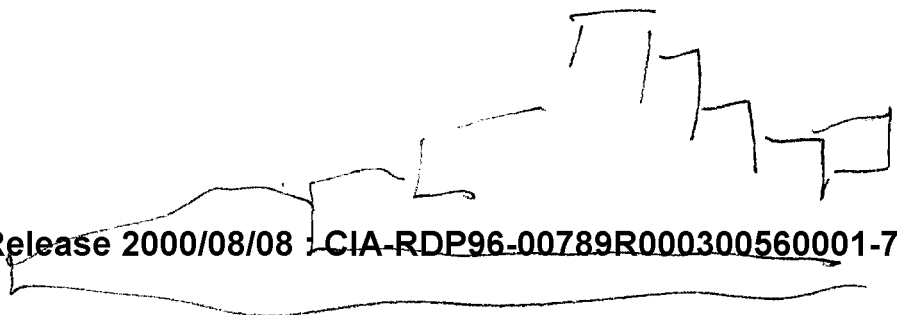
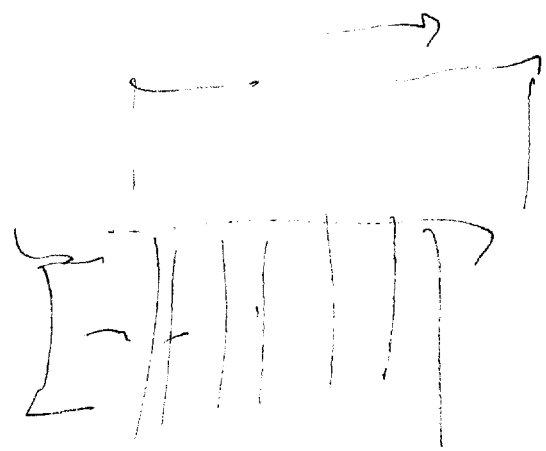
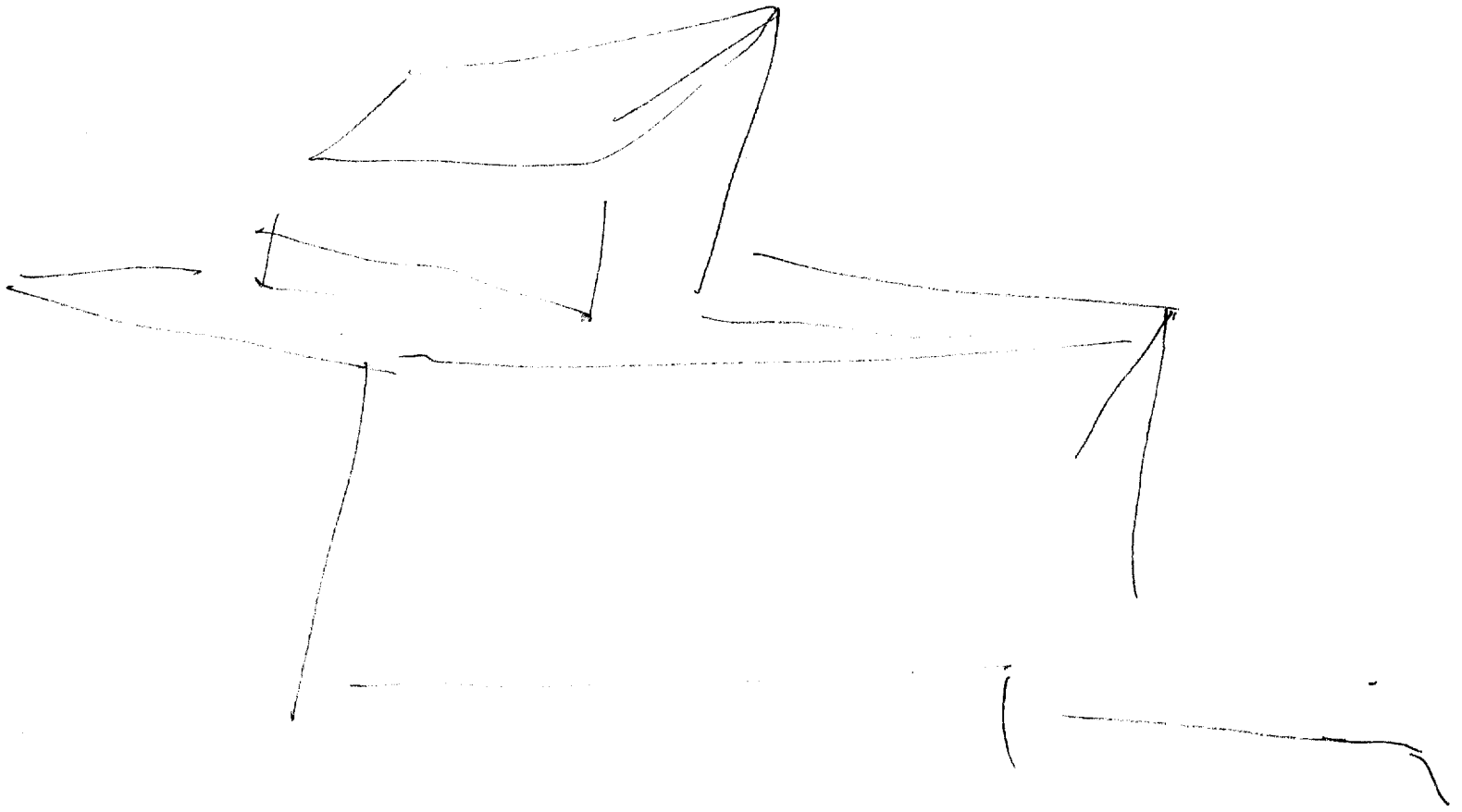

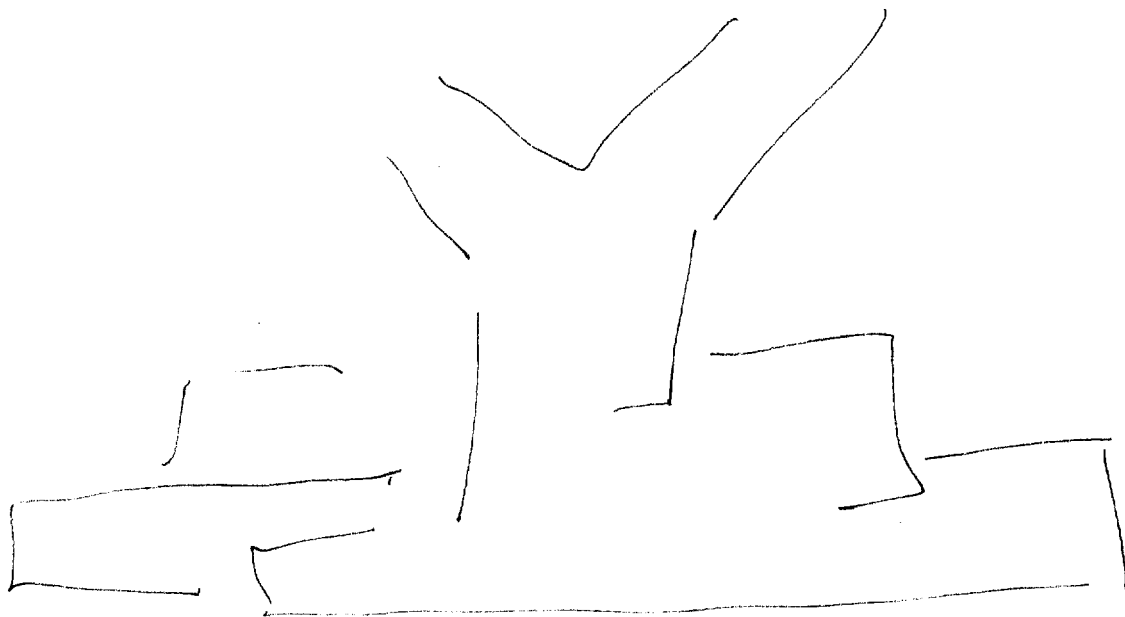
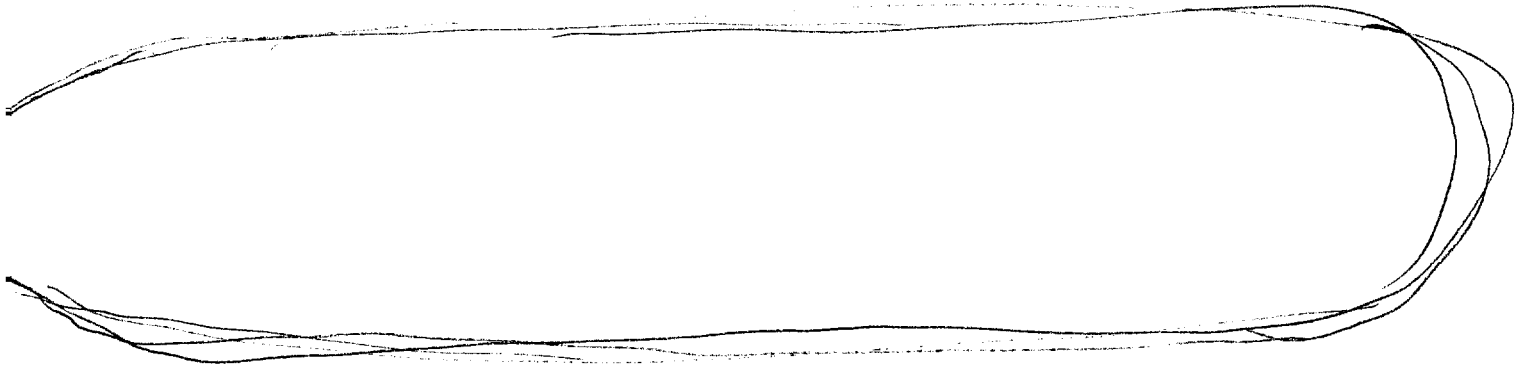

S2 D AI EI T I AOL AL

metal  
structures

gully  
black  
red

large

military

organized  
assigned  
watchers  
bracket

fence

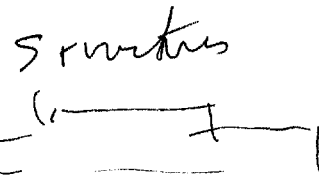

square  
angle  
rounded  
jumbled  
complex  
slip on  
curved

solid

5.2

D

H1

E1

T

F

APL

UAG

Orange

Breezy

Wide

Open

Surrounding  
water  
land

Warm  
Sunny

people  
white  
clothes

grey  
clothes

9-1/2 "like" uniforms, but not all the same.

green

APL BK  
like  
Bavarian  
Police  
Uniform

SUI

8

S 2

ALS

At Bk  
water not  
feel a little  
fence

red

Soviet  
presence

Submarine  
missiles

green  
black

rounded

hard  
smooth

long

wet

Sat's hot morning

At Bk  
Persian  
Orult  
Mines

white  
light  
but not

SVI

9

SZ

high up  
large  
solid

metal  
(length)  
structured

slightly

A1 B1  
mild vert 130

vessel

2 1/2 wide area

envelope  
distance  
3-dimensional

person

9 1/2 feels encompassed - attention in all  
directions - responsibilities - a little stressed &  
overburdened.

with

waiting



SVL

10

Tuning  
moving  
back/forth

alert

alert

S4 1/2 sense of impending threat or danger

S6 1/2 sound upset a sound like that, still day in  
desert in So. Nevada

land  
vehicle

parked  
maneuver

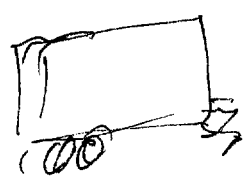

boxlike

S4 1/2 "like" - bivanon or TDC  
trailer

Squarish

SUI

11

5/1/2 maintenance level of operation. Few people compare to what usually would be needed. Cavabakbez.  
"Keep it warmed up" "stand-by"

Antenna

5/1/2 s. Fe here military related "lib" C<sup>3</sup> Electronics involved but not primary.

isolated

perimeter

connected  
contingency  
reserve  
prepared  
operational  
dormant

person

cadre

watching

binocular

aircraft

overhead

SVI

12

S2

D

A2

B1

T

I

ACR

AS

S+1/2 sense that situation is semi-equilibrium & may last indefinitely.

antennas

round  
lattice  
large  
turning

finding  
searching  
monitoring

battery

S+1/2 combat related. weapons involved. Targeting, mobile

ACR BK  
SAM-6  
launcher

vehicle

transporting  
operations  
holding

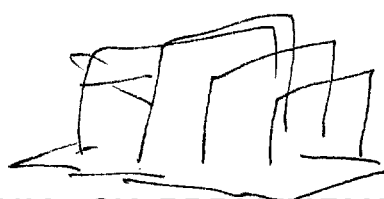

SUJ

13

SZ D H BZ T I Au

ALS

-deviation  
declination  
adjusting  
Cartesian  
diverting  
deflection

metal

rounded  
long  
solid

Smooth  
Several

is, used  
connected

slanted  
deviated  
movable  
moving  
curvilinear  
around  
tapering

Shell/2 Can be covered over for weather protection & protection from observation.

SUI

64

S2

PL

BT

T

I

ADL

ALS

metal

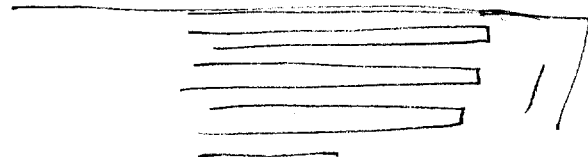

S&1/2 sides have indented pattern or ribs.

long  
wide  
high

amphibious

no for  
sound

dark  
brownish  
green

long  
very  
long

S&1/2 not fast - for carrying, not speed. For  
 fabricating specific weapons systems anywhere  
 even mount a road. "All-terrain" but still  
 limited because of size + engine power  
 capabilities. ~~limit~~ Not sufficient power for  
 height of vehicle to cover especially steep or  
 difficult cond. zones.

SUI

52

B

AI

EI

T

I

ASL

AL

Objects

Several

metal

5 1/2 Can come loose. Very long. "Like" tubes, w/ something



inside. Side by side.



ribbed  
jointed

ordnance

5 1/2 tubes long + protect. + Aim/guide/position  
launcher

S U I

16

S... AZ EI T I AZ AS

S4 1/2 Objects can be moved & replaced individually, but usually mounted together.

S4 1/2 Objects + vehicle seem associated w/ each other. Other vehicles + ~~set~~ trailers, etc. have some relationship. Large ground area involved. Separate places or gathering area are required.

Object that is shielded from view (c)

white



S4 1/2 / ADS - something unusual & unconventional about this. Doesn't seem especially complex - based on relatively simple principles.





S V J

17

S-2

A

A2

E-3

T

T

ACL

ALS

A2 BF  
541/2 makes  
my eye  
water

light  
blue

square

container

54 1/2 holds something.

denser  
rounded  
angled  
curved

Object

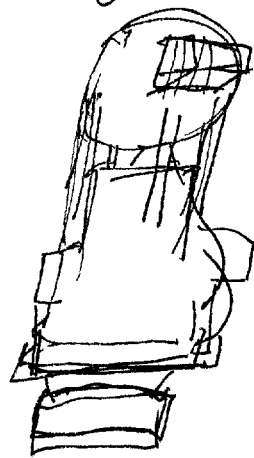

SVI

18

S2...

D

A2

E1

T

F

A2

Als

Semi-trailer  
flatbed

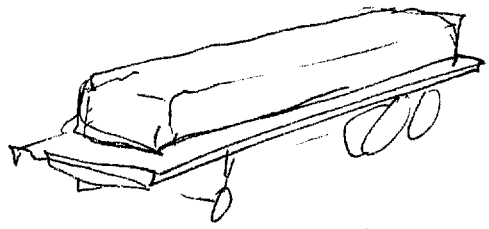

Head  
down

5-1/2

Covered + wrapped carefully. Large, long load.  
Use ~~the~~ crane of some sort to lift it  
with caution to avoid damage. PWA inside  
Something. Slides inside.

Sandy

Open

barren

rocky  
area

dry

Object of  
interest (c)

A2 B1  
nuclear  
weapon

SVI

19

AI

EI

T

I

Ad

Als

APL Bk  
new missile  
fielded on  
Soviet B

angles  
interconnections

object

trapped  
variable

like  
a  
tank

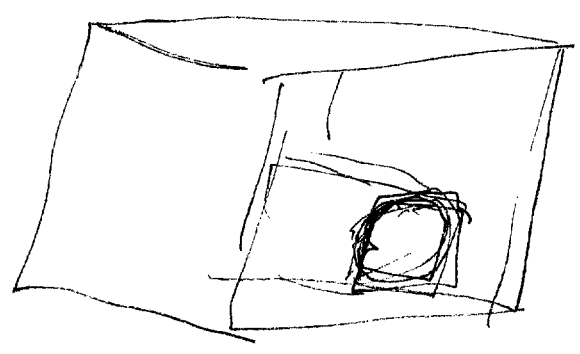

S4/2

Something inside. Something within objects  
can be rotated - Chicks as it goes

"like" octagonal or Hexagonal



"like" small tubes, pipes, or conduits coming  
out & going in.

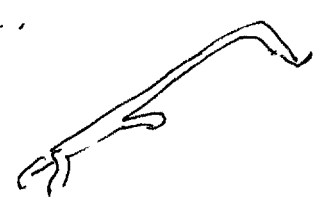

SUI

20

yellow  
orange  
red  
black

housing

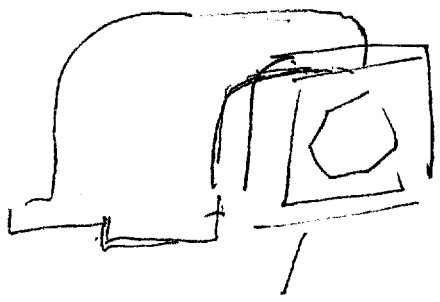

all Bk  
miss  
weapon

1414