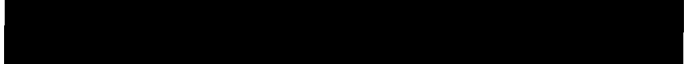

REMOTE VIEWING SESSION DATA

SG11

\*\*\*\*\*

\* Remote Viewer  \*

\* Interviewer  \*

\* Observer(s) : \_\_\_\_\_ \*

\* \_\_\_\_\_ \*

\* \_\_\_\_\_ \*

\* Date : ① 21/04/87 ② 23/04/87 \*

\* Starting time : \_\_\_\_\_ hours, local \*

\* Site # : 0761 \*

\* Site Acquisit.: CRV ERV PRV ARV BRV Other \_\_\_\_\_ \*

\* Working Mode : GT HEM Other \_\_\_\_\_ \*

\* Feedback class: A B C \*

\*\*\*\*\*

\*\*\*\*\*

\* Ending time : \_\_\_\_\_ hours, local \*

\* Notes : INITIAL SS TRAINING \*

\* Highest stage : 65 \*

\* Evaluation : 3 \*

\*\*\*\*\*

\*\*\*\*\*

\* Actual site : HISTORIC OBSERVATORY \*

\* RV summary : \_\_\_\_\_ \*

\* : \_\_\_\_\_ \*

\* : \_\_\_\_\_ \*

\*\*\*\*\*

This document is made available through the declassification efforts  
and research of John Greenewald, Jr., creator of:

# The Black Vault



The Black Vault is the largest online Freedom of Information Act (FOIA)  
document clearinghouse in the world. The research efforts here are  
responsible for the declassification of hundreds of thousands of pages  
released by the U.S. Government & Military.

**Discover the Truth** at: <http://www.theblackvault.com>

423186  
882917

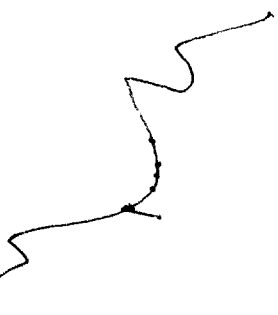

A across, incline  
up, angle up, across  
curving up, angle  
across, angle up  
avoid avoid  
hard

B. stretch

423186  
882917



S-3

hard  
smooth  
grey  
curving  
rounded

to across, angle  
up, angle across  
and

↳ shudder

to Break

like a dome

AOL SKETCH

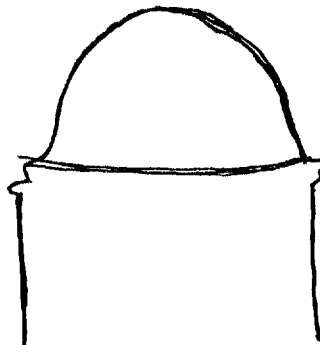

hard  
 smooth  
 gray  
 curving →  
 rounded →  
 straight  
 vertical

AOL BREAK  
 like the dome  
 on the capital  
 building or  
 other government  
 building

DARK  
 GRAYS  
 COOL  
 BREEZY

INSIDE

STRAIGHT  
 VERTICAL  
 OPEN

COLUMNS

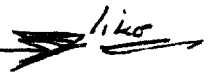

round →  
 archer →

AOL BK  
 GRANT'S  
 TOMB  
 N.Y.C.

MONUMENT  
 non-functional

stone  
 concrete  
 park-like

1/2 - shows something in the center of a round  
 open area AOL like a sculpture or statue.

SOMETHING  
OBJECTS  
EMANATIONS?

horse  
man

S-2            D            AI            EI            T            I            AOL            A/S

hard  
gray

INSIDE  
CENTER

stone

caved  
or  
shaped

smooth

rectangle

AOL  
GRANT'S  
TOMB!!

END 1053 hrs

S-2                    D                    AI                    EI                    T                    I                    AOL/S

quiet  
dimly lit  
shades of gray or

INSIDE

openess  
quiet reverence  
almost religious  
atmosphere

PEOPLE

come and go  
they don't stay here  
or work here

NORTH WALL  
EAST WALL

4 1/2 when looking at north wall it appeared to be covered with something. sec like a drape (a dark or black)

Break

4 1/2 - unusual site, it has some sort of deep meaning. but it means different things to different groups of people. The true meaning is hidden, it has been long forgotten.

1930

SOMETHING

hard  
cold  
smooth  
rounded

Stone  
rock

S-2 0 AI EI T I AOL/S

1930

ACTIVITIES

inside structure from top something should be visible 

shades of gray  
lack of color

rounded  
curving  
irregular shape

at curving around  
approaches  
medieval,  
wood

b. \_\_\_\_\_

natural shape

people

#1 - lot of people associated with site, but  
not necessarily inside.

1930  
ENTRANCE  
PERSON

↓  
funny looking hat  
flowing robe

#2 - person wearing robe and funny looking hat  
walking up steps of stone - goes into structure - kneels down and  
bows, touching floor with forehead. Drive



OBJECT  
IN  
CENTER

round  
rounded

break  
Everything is  
in motion  
can't focus

motion

reds

MOTION  
PRIOR C  
EMANATIONS?

---

moving  
swirling  
changing color  
dissolving  
vertical

reds  
yellows

purplish red  
blues

round  
curving  
rounded

angles  
square  
rectangular

object  
machine  
changing

MACHINE  
OBJECTS  
EMANATION?

square  
box

~~EMANATION~~

MACHINE  
ATTRIBUTES  
PRIOR EMANATIONS

SQUARE  
CHANGING

MACHINE SUBJECTS  
EMANATIONS?  
— SF

MACHINES  
TOPICS  
PRIOR EMANATIONS  
CHANGING  
COLORS

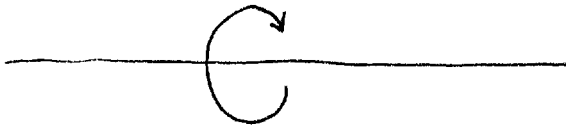

S-2      D      AI      EI      T      I      AC4/S

---

COLOR

changing movement

energy glowing

4 1/2 - there is movement and changing colors inside the object. The object is in the center of structure

dark

angles  
curving  
straight

hard  
smooth

There is an object that appears to change color from red to purple to blue. The object itself does not change color. The changing of color is produced by motion. The inside of this object is dark and rather colorless in itself.

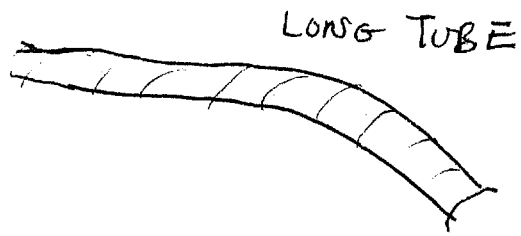

AOL  
Like a conduit

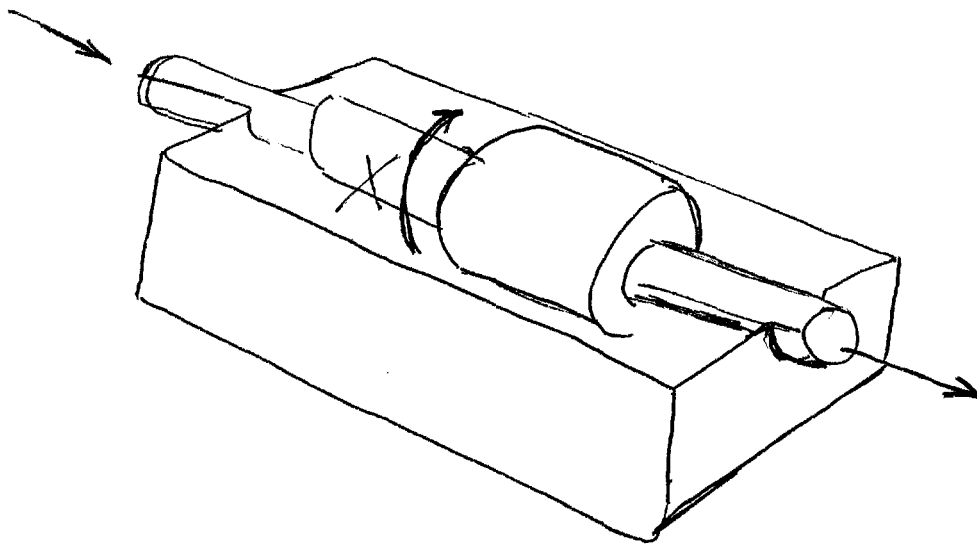

PERSON

TUBE  
OBJECTS  
EMANATIONS

TUBE

TUBE  
ATTRIBUTES  
EMANATIONS

round  
long  
curving  
sections

TUBE  
SUBJECTS  
EMANATIONS  
SOMETHING MOVES  
THROUGH THIS TUBE  
PARTICLE  
ENERGY

TUBE  
TOPICS  
EMANATIONS  
~~LARGE~~