

7 July 88
1000 hrs
Fr. Mexico
Solo

P.I. NONE/HUNGARY
A.V. NONE.

179010
~~864892~~

A: ACROSS
RISING
SMOOTH
HAND
B: LAND

SZ: TAN
LEADING POOL

FOR BLUE
SOUND

179010
~~864892~~

A: CIRCLING
MOTION
ENERGET
SOFT.

B: _____

179010
~~864892~~

A: ACROSS
FLAT
HAND
SMOOTH

B: LAND

A: RISING
VIBRATING
HAND
SMOOTH

B: _____

This document is made available through the declassification efforts
and research of John Greenewald, Jr., creator of:

The Black Vault



The Black Vault is the largest online Freedom of Information Act (FOIA)
document clearinghouse in the world. The research efforts here are
responsible for the declassification of hundreds of thousands of pages
released by the U.S. Government & Military.

Discover the Truth at: <http://www.theblackvault.com>

179010
864892

A: FANT
TENSE
SMOOTH

B: _____

A1 BAK:
TENSION

179010
864892

A: ACROSS
IRREGULAR
WAVE
DUMP
SMOOTH
HAND
MOTION

B: _____

179010
864892

A: ACROSS
SMOOTH

B: _____

A: RESINE
ANGLE
ANGLE
CONUS
HAND
UNNAMED

B: STRUCTURE

3

S2: ROUND
TALL
DARK
SOLID
PLAIN
HARD
CURVED

AOL BUK
BUILDING

AOL BUK
MINAROT

AOL BUK
SILO

AOL BUK
CANTON POWSON

AOL SKETCH:

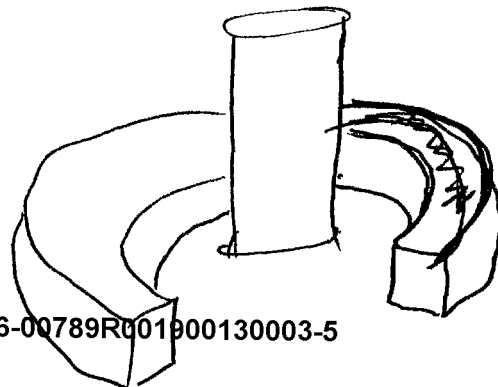

AOL BUK
CRAY
COMPUTER

4

179010
867892

Q: BLACK + FOXTROT
MOTION
SMOOTH

P: _____

SZ: PLUS
TAN
BLACK
HUMP
SOLID
TALL
ROUND

SK:

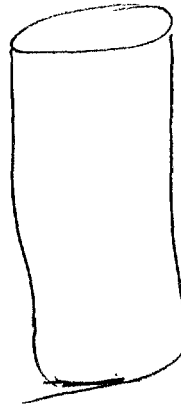

SK:

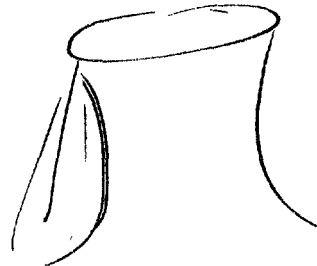

NO SK:
NUKE PLANT.

5

179010
864892

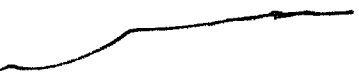

A: rising
ACROSS
SMOOTH
B: LAND

179010
864892



MISS ONE

179010
864892

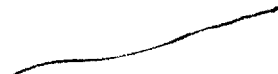

A: SMOOTH
ACROSS
RISING
WAVE
WAVE
B: LAND

179010
864892



A: RAMPY
ACROSS
JERKY
LAND
B: _____

④

179010
864892

A: SCASSI
TANO
MANAPO
B: STRUCTURE

B: REDDISH
TAN
BROWN
TALL
LIMBS
STRAIGHT

A/S
VERY VAGUE VISUAL
FROM WIND, BLD.

179010
864892

A: ACROSS
ANGLE
DOWN
MANAPO
B: STRUCTURE

S2: MOIST FEEL (TO M))
DRY LOOK
BRIGHT
WARM
FLAT
CROW
WIDE
SLOPE

SK! ~~EDGE~~
FLAT AREA
BOLD
BLD
6065

7

S2: SURROUNDING

FOR ALL
FUNCTIONS.

S3:

~~XXXXXXXXXX~~

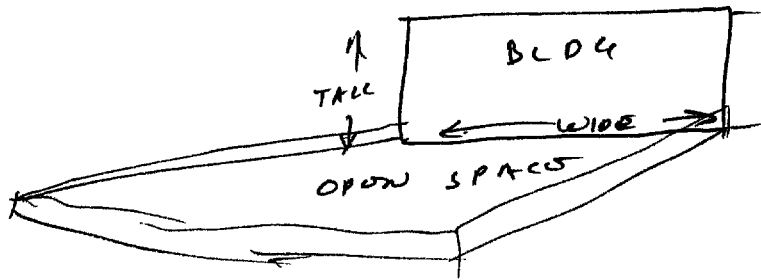

~~S2~~

0

M

07

(^T
OPEN SPACES)

near n/s.

FLAT
HARD
LEAD

PROVIDENT

FOR ALL
PARKING LOT
INSIDE BLDG.

S2

0

M

07

(^T
BLDG)

near n/s.

RODISH
~~PROV~~
BROWN

WIDE
TALL
SQUARE

S4 1/2

SOME KIND OF ROUND THING OF SQUARE BLDG, w/
STICKING UP.

8

HA BME
SMOKE STACK

S 4 1/2 IMMERSION ~~THAT~~ ROUND THING IS
PART OF BLOC, BUT NOT PHYSICALLY
CONNECTED.

MOUS TO 1 mile about the site + described.
S2 D M O T I M als.
SOUND

Hazy

HA BME
SURPRISE
RE AMAZING AMOUNT
OF AIR POLLUTION!

S2 D M O T I M als

BLOC
UNOON
DNY
SMELLY

HA BME!
UHH!
NOTICELY UNPLEASANT
ODOR!

④

DESCRIBE THE SITE FROM 1 mile up.

SL D M O T 1 NOC NLS.

DARK

(SITE)

DARK

LANDS

Site: ~~Site~~ NLS. VARIOUS VISUAL!

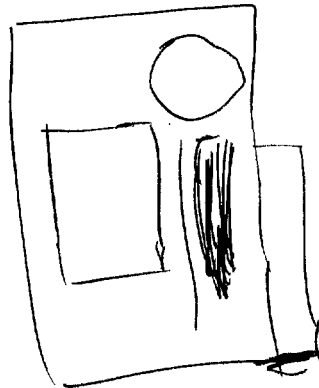

S4 1/2 IMPRESSION OF A LARGE RECTANGULAR AREA SECTORED OFF FROM SURROUNDING LAND. LARGE STRUCTURE IN MIDDLE, W/ ROUND STRUCTURE IN BACK. DARK AREA TO ONE SIDE, LIGHT AREA ABOVE & BELOW. LONG ADJACENT AREA OFF TO ONE SIDE.

S4 1/2 IMPRESSION OF DRY, RUDDY LAND, BUT LOTS OF UNIDENTIFIED VISIBLS.

S4 1/2 SORT - ISOLATED AREA

~~SL~~ ACCESS + DESCRIBE THE PERSONALITY OF SPECIFIC INTEREST.

S L O M O T , RA als.
(PERSON)

MALE
FEMALE

CONF NOTE:

CONFLICTING IMPRESSIONS OF PERSON: MALE/FEMALE.

AOL BK:
HOMOSEXUAL/
TRANSGESTITE/
SEX-CHANGE/
WHO KNOWS WHAT!

ACCESS + DESCRIBE THE PERSONALITY OF SPECIFIC INTEREST.

S L O M O T , RA als.
~~THIN + YOUNG~~
(PERSON)

S4 1/2 IMPRESSION OF THE PERSON AS A CONTINUANCE OF A PERSON, RATHER THAN IN PRESENT TIME ONLY.

YOUNG + THIN

OLDEN

AOL BK:
ISRAELI THIN
OF ~~WIT~~
SUSPECTED WWII
NAZI.

BREAK: 1040: STONY DRIVE ON LAST AGL:
BREAK.

ROUNDS: 1045

ACCESS & DESCRIBES THE PERSONALITY OF
SPECIFIC INTEREST.

SZ D RI ST T ' NO A/S.
(PERSON)

HOTRY SET

WOLF-DROSSO
LNOY/HTIN^{ING}

CHORER FOR LOOK

MODIUM

S4 1/2 IMPRESSION #1 E1 COLUMN: FEELINGS OVER AN
IMPERMEABLE SHELL WHICH COVERS OTHER FEELINGS.
TWO LAYERS OF FEELINGS, CLOSELY
SEPARATED.

