

~~SECRET~~

DATA SUMMARIES

(S/NF/SG/LIMDIS) Following are the perceived highlights from each source.

- (S/NF/SG/LIMDIS) Source A:
SG1B

-- The target [REDACTED] is associated with a light medium sized vessel that is off the coast of a sandy land water interface location. This vessel can move at a fast rate and is associated with a night time smuggling activity. In a hidden compartment below the deck where one can stand, there are burlap bundles containing either cocaine or some type of jewels (ornate objects). Emeralds, the term "Emerald" or the letter "M" may be related to the activity. An older looking white haired male who is loosing hair on the back of his head is wearing a large ring of significance. A family emblem may be related to the target. This man or one he knows has been jailed for smuggling in the past. Another man has dark hair, is ethnic or cultural and smokes cigarettes. The vessel itself may experience engine trouble in the form of black smoke in route to its final destination. A cutter may be involved with this scenario.

- (S/NF/SG/LIMDIS) Source B:

-- This target has the sensations, movements, spinning motions and concepts reminiscent of a helicopter, or relating to, thereof. There is not much description with this target because nearly all of the perceived information was in the form of sketches and figures (Attachments A-C).

-- The following "written" impressions were perceived:

- a strangely shaped propeller.
- vertical stripes.
- sharp angles and circles

REPRODUCTION REQUIRES
APPROVAL OF ORIGINATOR
OR HIGHER DOD AUTHORITY

FURTHER DISSEMINATION
ONLY AS DIRECTED BY DIA/PAG
OR HIGHER DOD AUTHORITY

CLASSIFIED BY MULTIPLE SOURCES
DECLASSIFY ON OADR

1

~~SECRET~~
NOT RELEASABLE TO FOREIGN NATIONALS
STAR GATE
LIMDIS

Enclosure 1

This document is made available through the declassification efforts
and research of John Greenewald, Jr., creator of:

The Black Vault



The Black Vault is the largest online Freedom of Information Act (FOIA) document clearinghouse in the world. The research efforts here are responsible for the declassification of hundreds of thousands of pages released by the U.S. Government & Military.

Discover the Truth at: <http://www.theblackvault.com>

~~SECRET~~

- a clear, glassy and shiny surface reminiscent of a "bubble".
- a spinning motion.
- the sensation of traveling forward and then dropping vertically straight down.
- wire mesh.
- a basket-like object being lifted/lowered from above.
- light reflecting off falling "dust" in the dark.

- (S/NF/SG/LIMDIS) Source C:

-- The target consists of a medium vessel that is on water; however, there is land nearby. This vessel is white on the top and gray, brown, tan, or black on the bottom. A flapping sound is associated with this vessel. Masts may be on this vessel. Smaller boats surround this vessel. Some of the smaller boats look like canoes and some look like dinghies. There are men in the smaller boats rowing up to this larger vessel. Then an off-loading occurs from the big vessel to the smaller vessels. Many people are involved in this activity. Contraband is involved.

-- The vessel and water were only part of the activity. Much work goes on here concerning the contraband on land and air. There was either a helicopter or airplane involved with the activity. This flying object at one point flew very close over the vessel. I felt that I was in a warm climate and many dark skinned people live and work here. There are some parts of the area where poverty exists.

-- As for location, at one point I could see a large structure that looked like a building that was sitting in water! Also, I had a feeling that the waters are conducive for whales or sharks.

-- At one point I could see gold coins in a big bag. The meaning at this point is unknown. Can address at a later date.

- (S/NF/SG/LIMDIS) Source C: (Additional Data)

-- Men that are in the water on smaller boats seem to be at times standing in the water. These men seem to be pulling something up and down. There is an up and down motion. There is

2

~~SECRET~~
~~NOT RELEASABLE TO FOREIGN NATIONALS~~
~~STAR GATE~~
~~LIMDIS~~

~~SECRET~~

an object that is associated with this activity that is heavy and rounded at one end or rounded at both ends (Attachment D). It seems that these men are very much out in the open on what they are doing.

-- On land, I could see men working also. It seems that they were bending over and working with green land. It reminded me of farming.

-- Again, the feeling of dark-skinned people. There are two men involved with activity. One is a young man with dark brown hair who seems to have good skills and knows exactly what he is doing. A second individual is an older male that has gray hair and a gray beard.

-- "Gold coins" could represent the contraband or the form of payment for the contraband.

-- The name "Harrison" phonetically surfaced.

REPRODUCTION REQUIRES
APPROVAL OF ORIGINATOR
OR HIGHER DOD AUTHORITY

FURTHER DISSEMINATION
ONLY AS DIRECTED BY DIA/PAG
OR HIGHER DOD AUTHORITY

3

~~SECRET~~
NOT RELEASABLE TO FOREIGN NATIONALS
STAR GATE
LIMDIS

~~SECRET~~

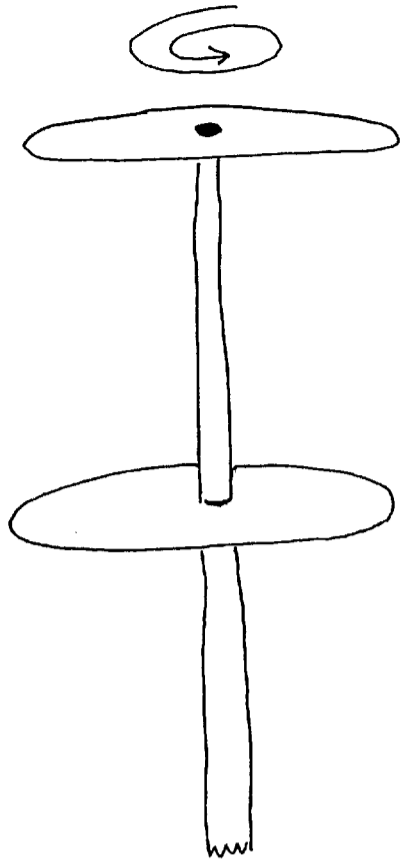

← entire object is spinning around

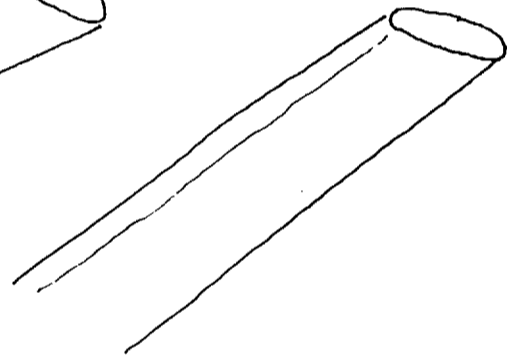
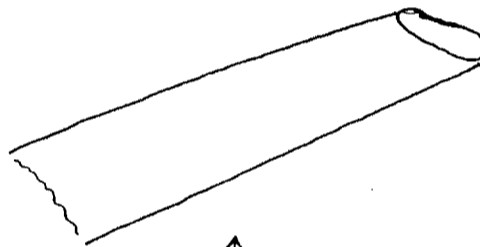

* mounted underneath a larger object

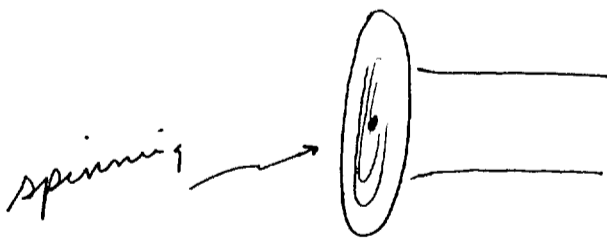

~~SECRET~~
NOFORN
STAR GATE
LIMDIS

Attachment A

~~SECRET~~

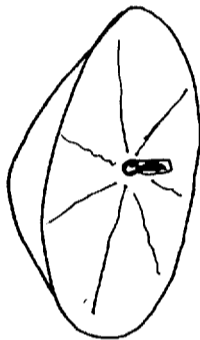
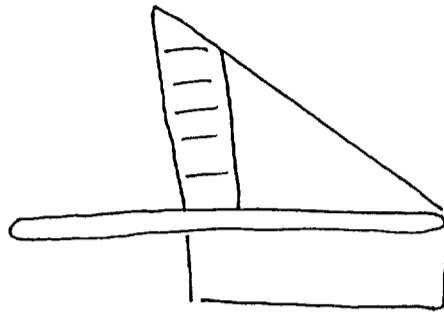
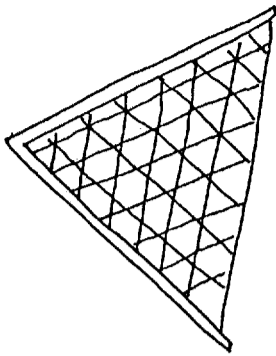

*This object is being
lifted / lowered
from above ; feels
like wire mesh
construction*

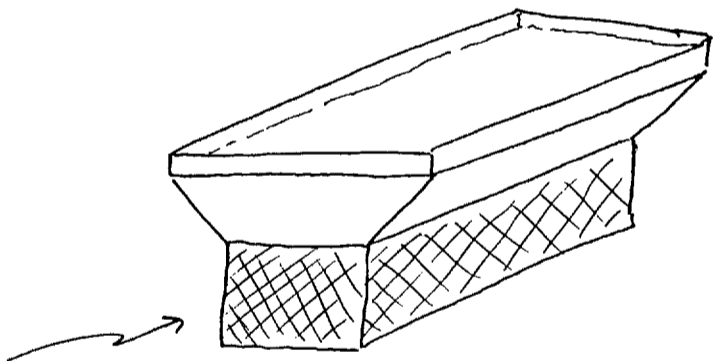

~~SECRET~~
NOFORN
STAR GATE
LIMDIS

Attachment B

~~SECRET~~

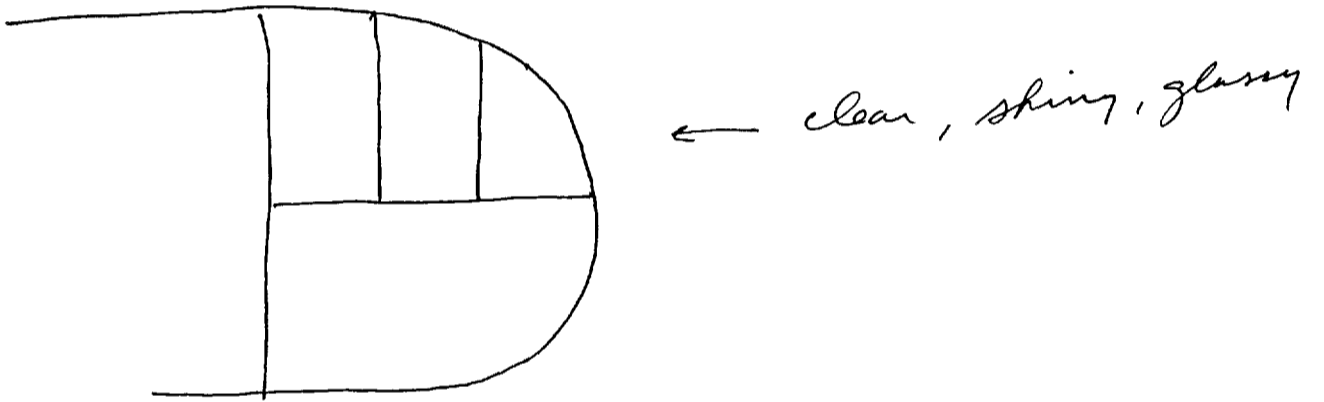
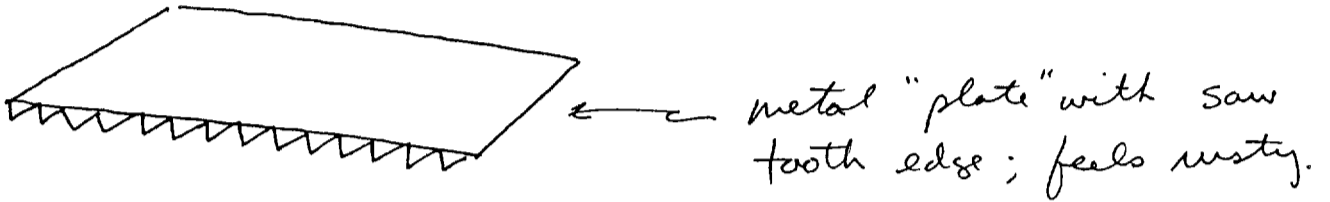
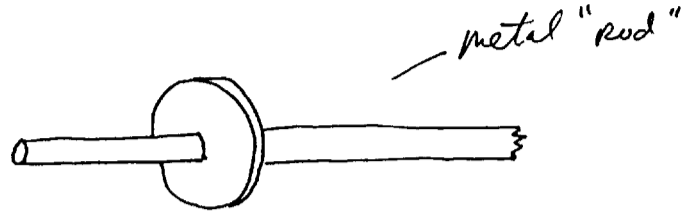
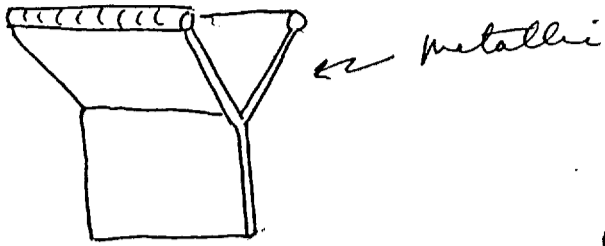

metal ; feels extended
or suspended ;
located on "the end"

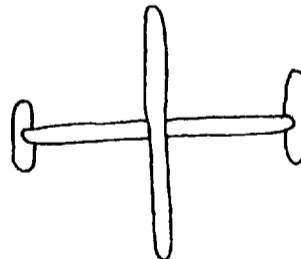

~~SECRET~~
NOFORN
STAR GATE
LIMDIS

Attachment C

Source C

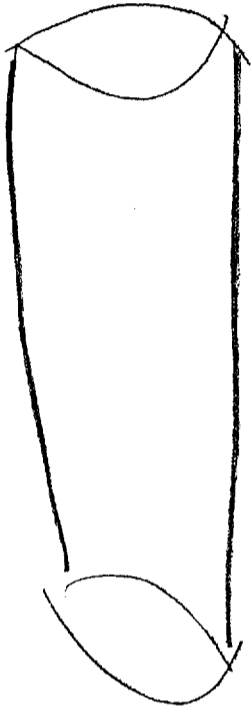

object

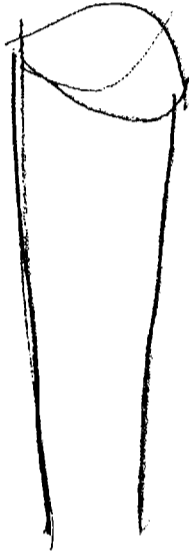

~~SECRET~~
NOFORN
STAR GATE
LIMDIS

Attachment D

~~SECRET~~

PROJECT EVALUATION FEEDBACK

PROJECT NO. _____
 DATE OF PROJECT _____

SG1J

The following is an evaluation form for the project you reviewed. Please complete this form and return to [redacted] Chief, Technology Assessments and Support Activity.

A. Is the information accurate? (Circle response)

<u>Categories</u>	Source <u>A</u>	Source <u>B</u>	Source <u>C</u>
Yes (true)	(1)	(1)	(1)
May be true	(2)	(2)	(2)
Possibly true	(3)	(3)	(3)
No	(4)	(4)	(4)
Possibly not true	(5)	(5)	(5)
Unsure	(6)	(6)	(6)

B. What is value of the Source(s)' information? (Circle response)

Major significance	(1)	(1)	(1)
High value	(2)	(2)	(2)
Of value	(3)	(3)	(3)
Low value	(4)	(4)	(4)
No value	(5)	(5)	(5)

UNCLASSIFIED WHEN BLANK

~~SECRET~~
 NOT RELEASABLE TO FOREIGN NATIONALS
 LIMITED DISSEMINATION
 STAR GATE

Enclosure 2

~~SECRET~~

C. Rationale for source evaluation. Provide rationale/analysis which led to your evaluation of responses provided above. Include confirmatory/new confirmatory data and whether collection requirements are currently validated/tasked to either obtain or verify such data. Please provide your written evaluation by source.

D. _____
 NAME

OFFICE/PHONE NUMBER

UNCLASSIFIED WHEN BLANK

~~SECRET~~
NOT RELEASABLE TO FOREIGN NATIONALS
LIMITED DISSEMINATION
STAR GATE