

UNCLASSIFIED//~~FOR OFFICIAL USE ONLY~~



# Defense Intelligence Reference Document

*Acquisition Threat Support*

31 March 2010

ICOD: 1 December 2009

DIA-08-1003-019

## State of the Art and Evolution of High-Energy Laser Weapons

UNCLASSIFIED//~~FOR OFFICIAL USE ONLY~~

This document is made available through the declassification efforts  
and research of John Greenewald, Jr., creator of:

# The Black Vault



The Black Vault is the largest online Freedom of Information Act (FOIA)  
document clearinghouse in the world. The research efforts here are  
responsible for the declassification of hundreds of thousands of pages  
released by the U.S. Government & Military.

**Discover the Truth** at: <http://www.theblackvault.com>

## State of the Art and Evolution of High-Energy Laser Weapons

Prepared by:

(b)(3):10 USC 424

Defense Intelligence Agency

Author:

(b)(6)

### Administrative Note

COPYRIGHT WARNING: Further dissemination of the photographs in this publication is not authorized.

This product is one in a series of advanced technology reports produced in FY 2009 under the Defense Intelligence Agency, (b)(3):10 USC 424 Advanced Aerospace Weapon System Applications (AAWSA) Program. Comments or questions pertaining to this document should be addressed to (b)(3):10 USC 424;(b)(6) AAWSA Program Manager, Defense Intelligence Agency, (b)(3):10 USC 424 Bldg 6000, Washington, DC 20340-5100.

## Contents

Summary.....	v
Introduction.....	1
Basic Attributes of Kinetic Energy and HEL Weapons .....	1
Elements of an HEL weapon .....	2
Laser Devices .....	3
Laser Fundamentals .....	3
Chemical Lasers .....	5
Solid-State Lasers .....	6
Rod and Slab Lasers .....	7
Fiber Lasers .....	8
Ultra-Short Pulse Lasers .....	10
Free-Electron Lasers .....	11
Beam Control and Atmospheric Propagation of Laser Devices.....	12
Brief History of DoD Laser Weapon Research .....	16
Laser-Material Interaction .....	20
Vulnerability of Spacecraft to Laser Radiation.....	22
Projection of Future HEL Weapon Capability .....	23
Recommendations.....	25
Sources of Further Information.....	26

## Figures

Figure 1. Utility of KE and HEL Weapons .....	2
Figure 2. Elements of an HEL Weapon System.....	3
Figure 3. Basic Laser Concept.....	4
Figure 4. Cylindrical Gain Generator for HF Chemical Space Based Laser .....	5
Figure 5. Common Solid-State Lasers and Their Wavelengths.....	6
Figure 6. Incoherent Combination of Single Mode Lasers at the Target.....	9

Figure 7. Incoherent Combination of Single Mode Lasers in a Fiber Combiner ..... 9

Figure 8. Free-Electron Laser Wiggler ..... 11

Figure 9. Elements of the 2 kW FEL at Thomas Jefferson National Accelerator Facility ..... 12

Figure 10. HEL Weapon Basic Tracking and Pointion Controls ..... 14

Figure 11. SeaLite Beam Director ..... 14

Figure 12. Typical Atmospheric Absorption and Scattering in the Infrared ..... 16

Figure 13. Army Mobile Tactical Unit ..... 17

Figure 14. Air Force Airborne Laser Laboratory ..... 17

Figure 15. Mid-Infared Advanced Chemical Laser ..... 18

Figure 16. MDA Airborne Laser in a Boeing 747-400F ..... 19

Figure 17. The Advanced Tactical Laser C-130 Aircraft ..... 20

Figure 18. Single Pulse Maximum Permissible Exposure ..... 22

Tables

Table 1. Laser Systems Irradiance Calculations ..... 25

## State of the Art and Evolution of High-Energy Laser Weapons

### Summary

The laser was invented in 1960, only 49 years ago, and (along with the light-emitting diode) has evolved into an essential part of our modern every-day life in ways that could not have been foreseen. On the military side, there have also been incredible advances in laser and beam control technologies but no deployment of any high-energy weapons. Many concepts have been developed and pursued, only to be discarded or deferred owing to technical immaturity, expected production cost, lack of apparent utility, or logistics concerns.

The most significant technical impediment to deployment may have been the large quantities of expensive and hazardous chemicals that were required by the only available high-average-power lasers. This is now changing with recent advances in electrically powered lasers (both solid-state and free-electron lasers). As these devices mature over the next few decades, they will enable practical military weapons at power levels ranging from kilowatts to megawatts. This evolution may be somewhat slowed or limited in the United States if there are policy concerns about the use of new types of weapons or about weaponization of space. As an example, the Department of Defense developed a microwave device for crowd control, called Active Denial, which has been shown to produce temporary pain without any injury. However, DoD was precluded from deploying it owing to policy (not legal) concerns. Other countries may not exhibit similar restraint, as evidenced by the open marketing of laser-blinding weapons despite a 1980 Geneva Convention prohibiting their development or use.

Space offers the ideal environment for laser beam propagation; there is no atmosphere to either attenuate or spread the beam. As a result, large distances could be bridged quickly, with range limited by the size of the transmitting telescope and the potential damage mechanisms limited primarily by the laser's output power. Initial spacecraft laser weapons are conceivable within the next 20 years, with the potential for follow-on growth in laser power and transmitting telescope size. Transmitting telescope size would be limited by the spacecraft size and competing demands for weight and volume. Laser power could grow to the megawatt range as solid-state and free-electron laser technology matures, but the major limitation to a spacecraft's weapon capability may prove to be its ability to generate and store the energy required by the laser and to store and dissipate the resultant waste heat.

## Introduction

The purpose of this report is to provide an overview of the current state-of-the-art and potential evolution of megawatt (MW) class high-energy laser (HEL) weapons. Implications for space vehicles in or beyond earth orbit will be addressed.

It is rare today to find an individual who doesn't have some concept of a laser weapon. From Orson Wells's Martian invaders in *War of the Worlds*, who used them with chilling efficiency, to the now-classic *Star Wars* movies, the capabilities attributed to such devices have grown with time and with writers' imagination. While most fictional depictions of laser weapons (and many news stories) are without sound basis, these devices do offer the potential for a whole new class of weapons and capabilities which may complement (but not replace) existing kinetic energy (KE) weapons and electronic warfare.

## BASIC ATTRIBUTES OF KINETIC ENERGY AND HEL WEAPONS

KE weapons (bullets, shells, missiles, bombs, and so forth) require a finite period of time to reach the target but are then able to destroy it instantly. They can deliver immense quantities of explosive energy and destroy large areas. This makes KE weapons most effective at engaging hardened, large, or stationary targets. Collateral damage concerns, such as a desired target next to a hospital, enemy forces near friendly forces, or a sniper target in a crowd can significantly limit the opportunity to use KE weapons. Randomly moving targets also present a challenge for KE weapons due to difficulties in predicting the target's location at the future time of arrival or in tracking the target with sufficient accuracy.

High Energy Laser (HEL) weapons, by contrast, begin delivering the laser beam's energy to the target at the speed of light. However, they require a finite dwell time to accumulate enough thermal energy (heat) on the aim point to achieve the desired effect (similar to a blowtorch). The strength of an HEL weapon is its ability to precisely deliver a limited quantity of energy to a small spot with little collateral damage to nearby objects or people. The instantaneous measure of a focused laser beam's effectiveness is called "irradiance" and is measured in power per unit area over the laser spot (typically watts/cm<sup>2</sup>). The beam's ability to inflict damage, by heating during a time interval, is called "fluence" and is typically measured in joules/cm<sup>2</sup>. Fluence is simply irradiance × time and one joule is equal to one watt for one second.

Speed-of-light energy transfer, coupled with precision tracking, allows HEL weapons to efficiently engage softer targets which are highly maneuverable, only visible for short periods of time, or at extremely long range. Although the initial cost of a laser weapon might be high, the logistics trail is short and the cost per shot is comparatively inexpensive since the only major expendables are laser chemicals or electricity.

Figure 1 compares the relative strengths and weaknesses of KE & HEL weapons for different classes of potential targets. Just as there is a wide variety of KE weapons (ranging from bullets to precision guided munitions to nuclear weapons) for different types of applications, one could envision a range of future HEL weapons at different power levels, wavelengths, weights, volumes, and costs which would be best suited for specific applications.

*HEL and Kinetic Weapons offer complementary capabilities*

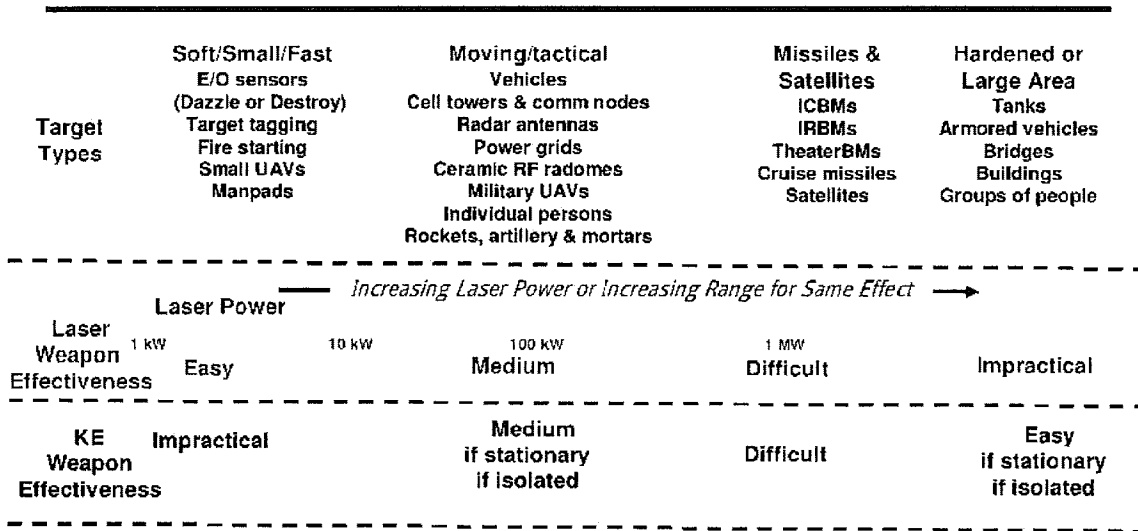

Figure 1. Utility of KE and HEL Weapons

### ELEMENTS OF AN HEL WEAPON

The purpose of an HEL weapon system is to place and maintain the focused laser beam on a target aim point for sufficient time to cause the desired heating effect. To accomplish this, the weapon beam is generated by the laser device, then shaped and relayed to the input of a pointing telescope (Figure 2). Laser beam sensors and steering mirrors are required to maintain the HEL beam centered as it traverses the optical train. The pointing telescope, which typically sits on azimuth and elevation gimbals, then expands the beam to the diameter of its primary mirror and focuses it to the range of the target while an imaging system (which can use a separate telescope or share the transmitting telescope) acquires the target, tracks it, and points the transmitting telescope's beam at the desired aim point. If the HEL beam's propagation path from the weapon to the target includes the earth's atmosphere, it can have a significant deleterious effect. Absorption and scattering of the beam, which reduce its strength at the target, are caused by molecular constituents of the atmosphere and aerosols such as haze or dust. Additionally, atmospheric turbulence spreads the focused spot and further reduces its effectiveness. All of these factors must be taken into account when designing a laser weapon.



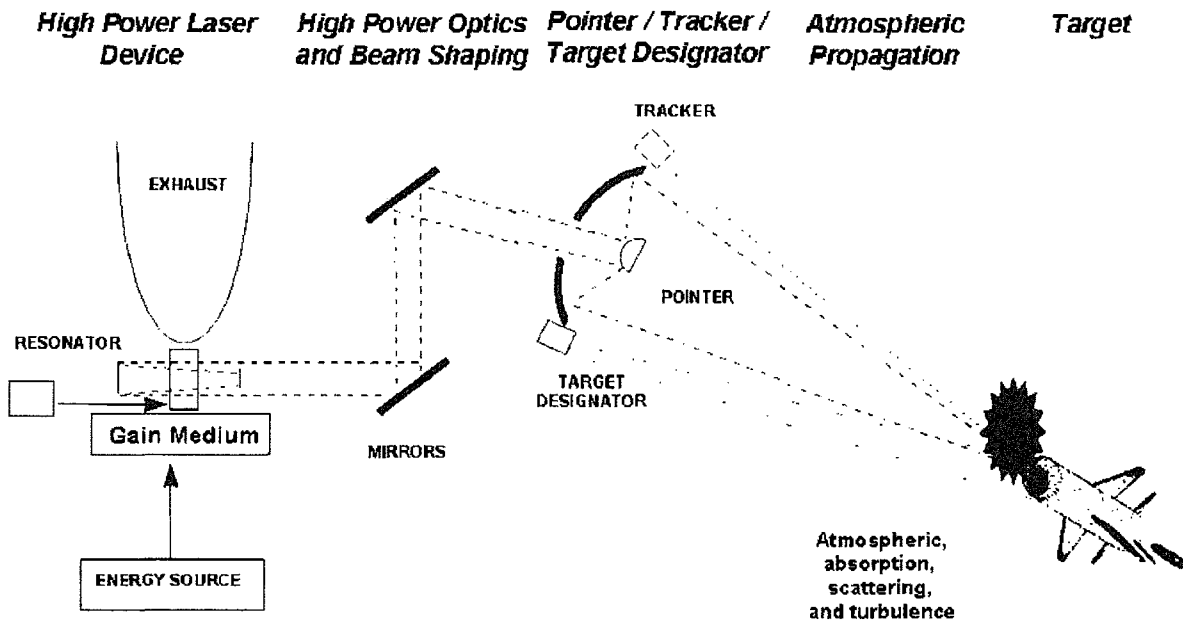

Figure 2. Elements of an HEL Weapon System

## Laser Devices

### LASER FUNDAMENTALS

The term "Laser" is an acronym for Light Amplification by Stimulated Emission of Radiation. It is a unique device that employs the quantum states of matter to store and convert energy into electromagnetic radiation. The resulting radiation is referred to as "coherent," meaning it is single wavelength or "monochromatic" and highly focusable due to its well controlled phase. In its simplest form, any laser device can be viewed as an "energy-conversion" box with one input and two outputs. The input is energy, which can take a variety of forms (electricity, light, or a chemical reaction) depending on the specific laser, while the two outputs are a coherent beam and heat (Figure 3). Since the overall energy-conversion lasing process is considerably less than 100 percent efficient, significant waste heat is generated which must be removed from the laser. Inside the laser is a "gain-medium" which stores a fraction of the input energy in its atoms or molecules and then releases the energy at the laser's selected wavelength. The laser also contains "resonator" mirrors which repeatedly relay the beam back and forth through the gain medium to increase its energy level. The laser device functions as the optical equivalent of an electrical oscillator with the resonator optics providing the feedback. Different lasers, which use various materials as their gain medium, emit radiation at wavelengths ranging from the infrared through the visible spectrum and into the ultraviolet.

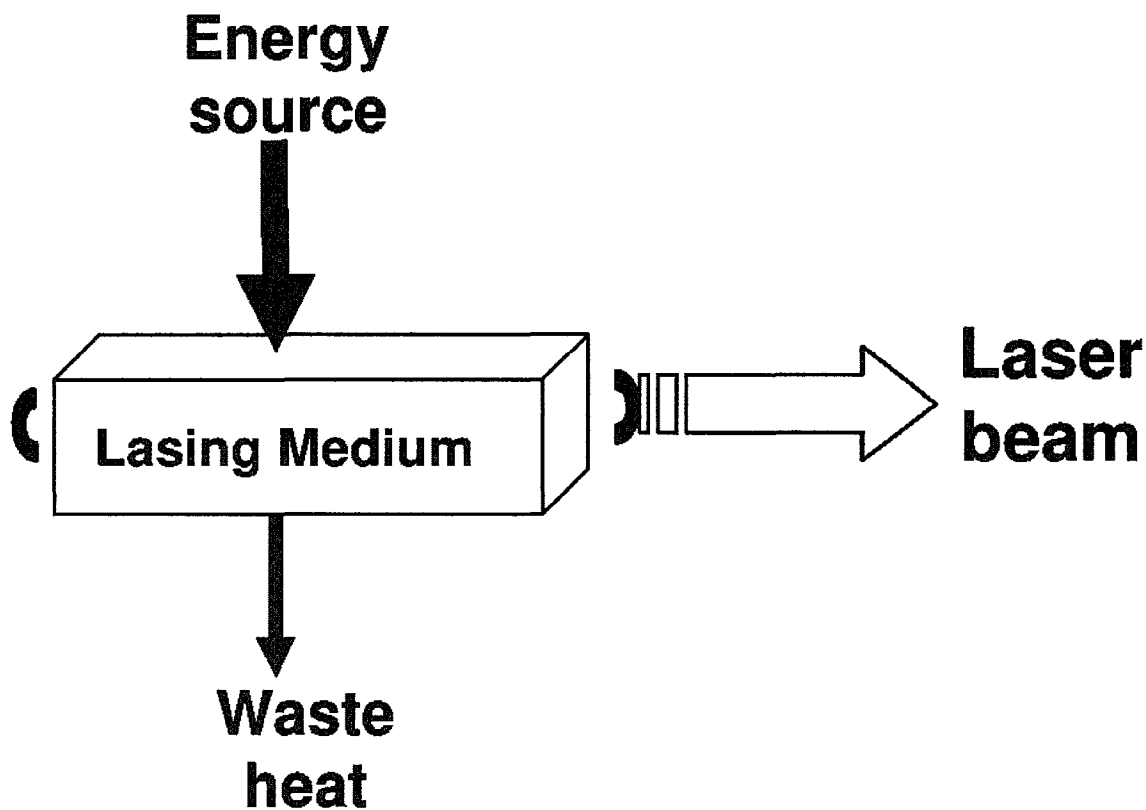

Figure 3. Basic Laser Concept

The principles behind the laser were first described by Basov and Prokhorov at the Soviet Lebedev Institute of Physics in 1952. The first concept demonstration was actually at microwave frequencies (24 GHz) in 1953 by Townes, Gordon, and Zeiger at Columbia University. They called their device a MASER for Microwave Amplification by Stimulated Emission of Radiation. The first working laser, initially called an "Optical MASER," produced milliwatts of visible light using a ruby rod as the gain medium. This was done in 1960 by Theodore Maiman at Hughes Research Laboratories in California. Since then, many types of lasers have found uses in an extremely wide variety of applications ranging from everyday life (bar code readers, CD players, flashlights), to industry (cutters, welders, surveyors, levelers), to the military (range finders, precision guided munitions, dazzlers). These lasers have proven to be inexpensive when produced in large quantity, rugged, reliable, and safe.

Since the earliest days of the laser, the Department of Defense (DoD) has conceptualized and led the development of high-average-power lasers for weapon applications. There have been many open literature reports of similar work in Russia, China, and other countries. Lasers currently exist in a wide variety of forms with many solids, liquids, gases or even electrons being used for a gain medium to produce beams over a wide range of wavelengths and power levels. However, only a small group of laser types have shown the potential to produce weapon level powers.

## CHEMICAL LASERS

Chemical lasers use a chemical reaction in gas or liquid to release the energy which produces their lasing. A reaction can be initiated with an electric current, by light from another source, or by simply mixing hypergolic chemicals. These lasers include familiar low power, sealed gas types such as helium-neon, argon, or krypton-ion and typically produce light in the visible or near infrared. Excimer lasers are another low average power sub-category of gas lasers. These use dimer molecules as the lasing medium, are generally electrically excited, and lase in the ultraviolet.

To-date, every laser which has been scaled to MW-class average power falls in the chemical category. They use large quantities of rapidly flowing chemicals to produce reactions which then release the required energy. The carbon dioxide laser ( $\text{CO}_2$  at  $10.6 \mu\text{m}$ ) was the first to be scaled to high power around 1970 followed by the deuterium-fluoride laser (DF at  $3.8 \mu\text{m}$ ) and its first cousin the hydrogen-fluoride laser (HF at  $2.8 \mu\text{m}$ ) in the mid-1970s. These devices lase in the far- to mid-infrared and depend on exciting vibrational and rotational states of the lasing molecules.  $\text{CO}_2$ , DF, and HF lasers resemble rocket engines because they combust a fuel with an oxidizer. The DF laser ignites a mixture of nitrogen-trifluoride ( $\text{NF}_3$ ) with ethylene ( $\text{C}_2\text{H}_4$ ) and then injects deuterium (an isotope of hydrogen) into the exhaust stream to produce the lasing molecule of deuterium-fluoride. This laser was the choice of the Navy and Army in the 1970's and 80's for tactical laser development while the HF laser was the choice of the Strategic Defense Initiative (SDI) for their Space Based Laser development in the 1980's (Figure 4).

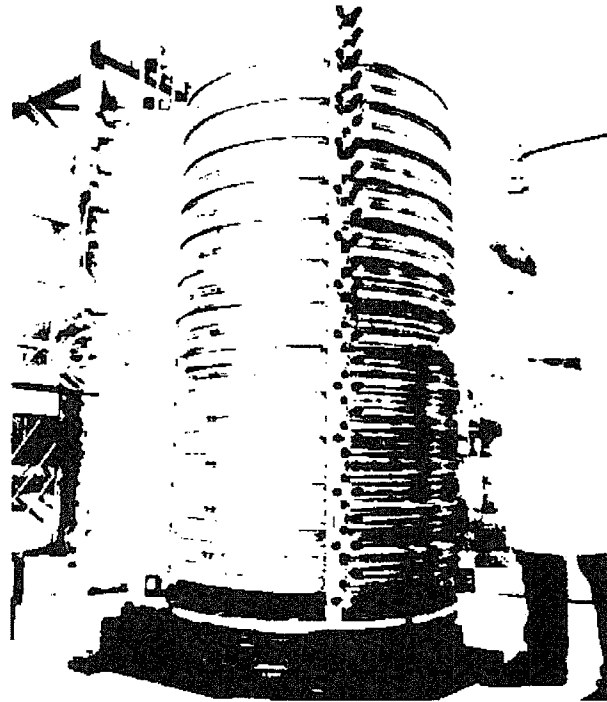

Figure 4. Cylindrical Gain Generator for HF Chemical Space Based Laser

The newest chemical laser to be scaled to high power is the Chemical Oxygen Iodine Laser (COIL at  $1.315 \mu\text{m}$ ) which excites vibronic states (simultaneous change of vibrational and electronic quantum numbers) in monatomic iodine to achieve the near-infrared wavelength. COIL generates light in a more complex process which does not involve combustion but still releases considerable heat. Gaseous chlorine ( $\text{Cl}_2$ ) is mixed with a destabilized hydrogen-peroxide ( $\text{H}_2\text{O}_2$ ) mixture to produce an excited oxygen molecule and water. The oxygen molecule is then combined with iodine ( $\text{I}_2$ ) in a reaction which separates the iodine molecule into monatomic iodine and transfers the oxygen molecule's energy to it. Iodine then becomes the lasing atom. This near-infrared laser was the device of choice for the Missile Defense Agency's Airborne Laser program.

Typically in a chemical laser, 10 to 20 percent of the energy released in the chemical reaction will result in lasing while the other 80 to 90 percent becomes heat. Fortunately in a flowing gas laser, the heat can be easily removed from the resonator region of the gain generator by the exhaust gas. It is this efficient heat removal mechanism which has allowed chemical lasers to be scaled to such high average powers. If a MW-class laser were required today or in the next few years, chemical lasers provide the only available options. Because they use large quantities of hazardous chemicals and need refueling, this type of laser is not a preferred choice by the military.

The physics and scaling of chemical lasers such as DF, HF, and COIL are well understood and, in principal, they could be scaled to power levels significantly beyond the MW level. However, due to the maturity of these technologies, only marginal further efficiency improvements are likely. As a result, the quantity of chemicals which must be stored and consumed for a laser beyond ~ 10 MW would make the concept highly impractical for space-based applications and extremely cumbersome for ground based lasers. Additionally, the atmospheric degradation of a laser beam propagating from ground to space makes these wavelengths impractical at power levels beyond 10 MW.

### SOLID-STATE LASERS

The earliest and perhaps the most diverse laser category is the solid-state laser which uses specific atoms or molecules as a lasing gain medium (called the dopant) uniformly suspended in transparent crystalline or ceramic glass (called the host). For example, the familiar Nd:YAG laser uses a few percent of neodymium (Nd) atoms as the dopant suspended in a crystalline mix of yttrium, aluminum, and garnet (YAG). Figure 5 shows some of the many combinations of solid-state laser dopants and hosts in use or being developed today.

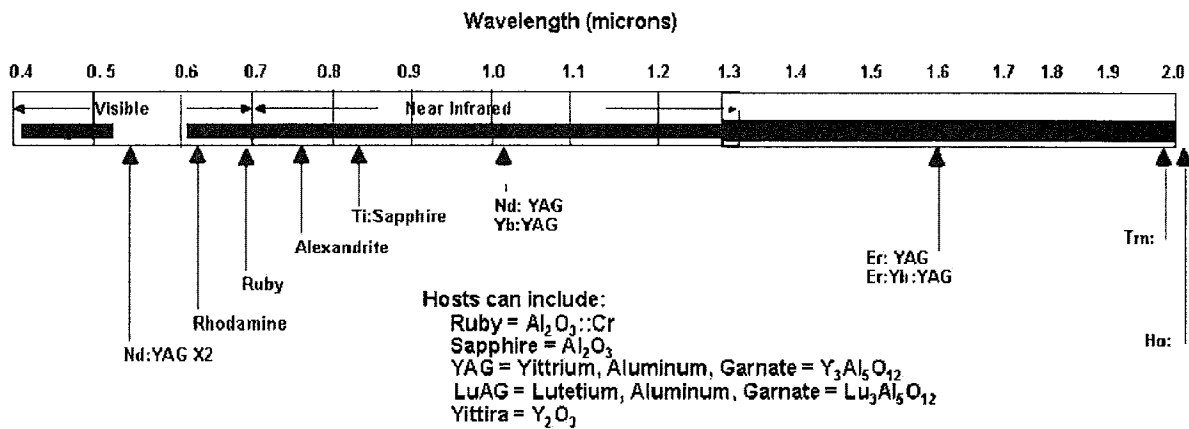

Figure 5. Common Solid-State Lasers and Their Wavelengths

A major advantage of solid-state lasers for mobile or portable applications is that they only require electricity to power them although cooling is also needed. For example, a 5 second run of a 15 percent efficient 100 kW laser would require less than one kilogram of gasoline or diesel fuel. No hazardous chemicals are needed and an

extremely deep magazine becomes possible. These attributes combine to make solid-state lasers very attractive for both civilian and military applications.

## ROD AND SLAB LASERS

The earliest solid-state laser mediums took the shape of a cylindrical rod and were optically pumped with flashlamps. Higher power solid-state lasers were later made using larger rectangular slabs since the amount of laser power which can be extracted increases with the lasing medium's volume. Additionally, rectangular geometries allowed more efficient optical pumping and cooling. Newer solid-state lasers were pumped with semiconductor diodes which emitted light more efficiently than flashlamps and at wavelengths which were more useable by the gain medium. Like chemical lasers, they are considerably less than 100 percent efficient overall and generate heat. However, solid-state lasers accumulate heat in the glass lasing medium where the resulting thermal stresses can distort the lasing beam enough to render it useless or even crack the glass. Since the glass-based medium is a poor thermal conductor, it is difficult to remove heat. Thus, thermal management of the gain medium imposes fundamental limits to increasing the average power in a single slab laser. Much of the recent research in slab lasers has focused on developing innovative ways to remove this heat or to combine beams from many smaller slabs.

In order to combine laser beams in a fashion which retains good overall beam quality, the wavelength, phase, and polarization of the individual beams must be tightly controlled. This process is referred to as "coherent combination" or "phasing" and results in the maximum irradiance ( $\text{watts/cm}^2$ ) by minimizing the focused spot area over which the total laser power is spread. If an application (such as welding or machining) depends more on total power than on minimizing spot size, then coherent combination is not needed and the laser beams can be separately focused to the same spot with no regard to differences in wavelength, phase, or polarization. This technique is called "incoherent combination."

Major progress has been made in slab laser development during the last few years. Northrop-Grumman, under a DoD-funded program, recently produced 100 kW with good beam quality. This laboratory device, called the Joint High-Power Solid-State Laser (JHPSSL), uses a single Nd:YAG master-oscillator that feeds parallel, well-phased Nd:YAG power amplifiers. Brute-force power scaling, well beyond 100 kW, seems relatively straight-forward using approaches available today. Unfortunately, as more lasers are combined the overall beam quality will deteriorate while the parts-count, complexity, and fragility increases. This makes either militarization at the 100 kW level or laboratory scaling to/beyond the MW level unlikely in the near-term with this approach. However, given the recent rate of progress and the relative immaturity of the technology, it would be reasonable to expect further major technological breakthroughs in thermal management and phasing, cheaper/more powerful pump diodes (the major cost today), and far more rugged engineering. These improvements could be expected to yield affordable, rugged, militarily useful MW-class slab laser systems with reasonable beam quality within the next 20 years. Much of the relevant research is occurring outside of the United States.

## FIBER LASERS

Fiber lasers are also solid-state lasers but are frequently considered separately due their many differences in implementation. They are made of the same materials listed in Figure 4 and lase at the same wavelengths. A fiber laser can be visualized as a rod laser which has been stretched many meters with a resulting diameter about the size of a human hair. The fundamental reason is to improve heat dissipation. The ratio of a fiber's surface area to its volume is much greater than a rod or slab and the distance which heat must travel to the edge of the lasing medium is reduced by orders of magnitude. The lasing fiber is surrounded by a concentric, larger diameter undoped fiber into which pump light is injected (usually at the ends) and then allowed to leak into the lasing fiber along the entire length. Fiber lasers are manufactured or "pulled" in much the same way as conventional optical communications fibers. Because the fibers are so thin, the power which can be generated in any one lasing fiber before the onset of damage is currently quite limited. New approaches to injecting the pump light and controlling the laser beam as it is generated or amplified are occurring almost daily. Fibers have been constructed using multiple cores, photonic crystals and air spaces in order to increase the power of individual fiber lasers with good beam quality and in ways to combine the beams.

The smallest diameter fiber lasers, which produce single mode beams with very good wavelength control and stable polarization, have demonstrated a few hundred watts and are currently thought to have a damage threshold upper bound of about 10 kW. Small numbers of these beams have been coherently combined using techniques which match wavelength, phase and polarization of each fiber laser in the cluster. The bandwidths of these laser/amplifier chains must be extremely narrow ( $\ll 1$  GHz) to maintain polarization and to then be coherently phased to about  $0.1 \lambda$  rms. It remains to be seen how much total power can be generated with good beam quality and what are the fundamental limits to coherent combining. Phasing research into mechanical techniques which use deformable mirrors and passive approaches which use stimulated Raman scattering are both being aggressively pursued. These combining techniques, when applied to fiber lasers, are in their infancy and offer the potential for weapons with fairly long tactical ranges.

Other single mode fiber lasers have been produced which generated as much as 5 kW. Although their outputs are of good beam quality, they lase over a wavelength band which is too broad to maintain polarization and cannot be coherently combined. However, these types of beams can be combined incoherently by individually focusing them onto the same spot (Figure 6), similar to incoherent combination of slab laser beams or by physically splicing the output fibers of the individual lasers onto a larger undoped fiber (Figure 7) which can accommodate the higher total power.

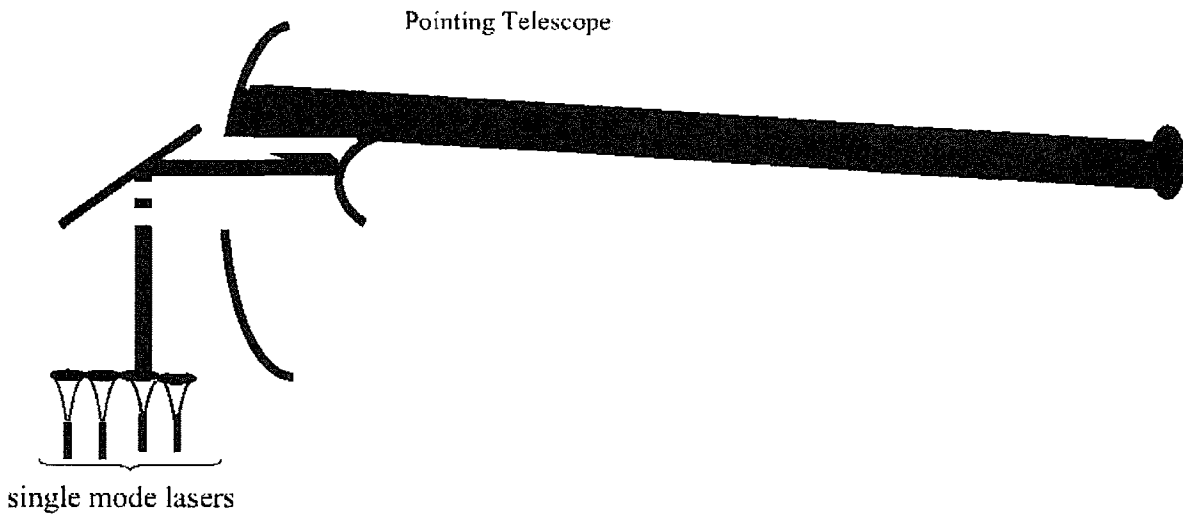

Figure 6. Incoherent Combination of Single Mode Lasers at the Target

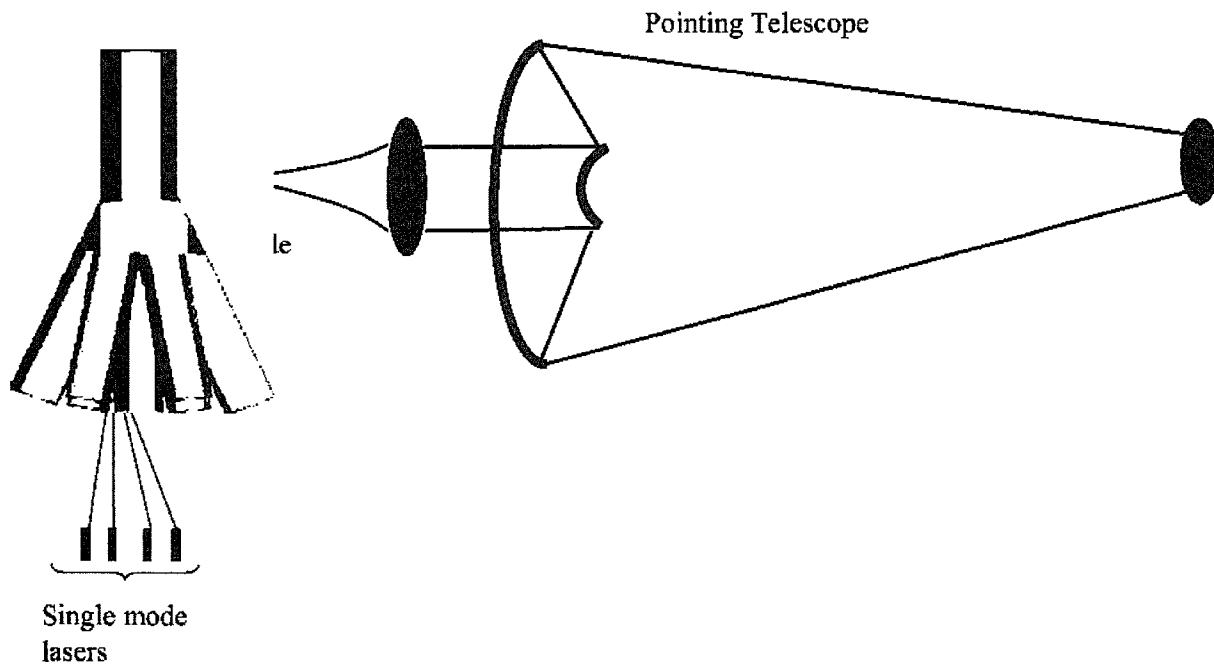

Figure 7. Incoherent Combination of Single Mode Lasers in a Fiber Combiner

This larger fiber does not maintain the beam quality of the individual laser beams and results in performance roughly equivalent to separately focusing the beams onto a single spot. For example, seven individual fibers have been combined into a larger fiber to produce a single beam with a beam quality of about 6 times the diffraction limit and

25 to 50 fibers have been combined into an even larger fiber with a resultant output power of 50 kW and an effective beam quality of about 30. Highly reliable commercial welders and cutters are made today with fiber lasers which combine beams by splicing laser fibers together to increase output power. Some of these devices operate at a reported wall plug to light-out efficiency > 30 percent but these numbers do not include any power required for cooling. As a weapon, these off-the-shelf lasers could produce useful beams for short distances.

A significant advantage of fiber lasers is their inherent ruggedness when compared to slab or rod lasers. Most of the optical functions (such as wavelength and polarization control, beam splitters and combiners) which are required to produce a high-power beam with good beam quality can be integrated into the fibers while slab laser systems require discrete components which must be kept clean and held in mechanical alignment.

Given the immaturity and rate of advance of fiber lasers today, it is impossible to predict where they will go. Current power scaling research has been centered on Yb:YAG and Nd:YAG fibers at 1  $\mu\text{m}$  with limited effort at 1.5  $\mu\text{m}$  and 2  $\mu\text{m}$ . Although lagging the maturity of 1  $\mu\text{m}$  fibers, they offer potential for increased eye safety.

If the maturation process continues as it has, fiber lasers will offer the best promise for high power and good beam quality with inherent ruggedness and reliability. Militarized devices at the 50 kW to 100 kW should be available within the next 15 years and it's not difficult to imagine MW systems within 20 to 30 years.

## ULTRA-SHORT PULSE LASERS

Ultra-Short Pulse (USP) lasers, sometimes called femtosecond (fs) lasers, produce pulses of light shorter than 1 picosecond ( $10^{-12}$  second). Some USP lasers have produced pulses less than 10 fs which is a length of 3 microns and equivalent to only a few cycles of visible light (by comparison, a human hair is about 100 microns in diameter). They were developed in the 1970s using long pulse lasers to illuminate chemical dyes which then produced the short pulses; today USP lasers employ slabs such as Titanium:Sapphire or a variety of fibers and table-top size devices are commercially available. Although the average power of these devices is typically sub-watt, the short pulses result in peak powers which can range from a terawatt ( $10^{12}$  watts) to a petawatt ( $10^{15}$  watts). The extremely high power contained in very short pulses has proven useful for precision machining, drilling tiny holes, and selective material removal in a wide variety of materials. In addition to commercial machining applications, medical uses such as eye surgery and cancer cell destruction have been developed. When propagated in the atmosphere, these ultra short pulses do not obey the usual laws of diffraction spreading and can (under certain circumstances) remain tightly focused over long distances. This technology remains in its infancy and research is ongoing to increase average power (generally with a higher pulse rate), to better understand the physics of USP propagation, and to explore material interactions with USP. Much of the USP research today is found in world-wide academic institutions. Other than the potential for inflicting sensor damage, the military potential of these devices is yet to be determined.



## FREE-ELECTRON LASERS

Free-electron lasers (FELs) are unique in that they are not limited to lasing only at specific wavelengths dictated by the characteristics of a specific solid, liquid, or gaseous gain medium. FELs use a stream of "free" (unbound to atoms) electron bunches, moving at almost the speed of light, to provide the lasing medium. These short bunches of electrons are generated by a photocathode and accelerated by an RF linear accelerator which is powered by klystron tubes. The relativistic electron bunches are then passed through an alternating-polarity set of magnets, called a "wiggler" or "undulator" (Figure 8) which transversely accelerates the electrons and converts a small fraction of the electron bunches' energy into a coherent optical energy.

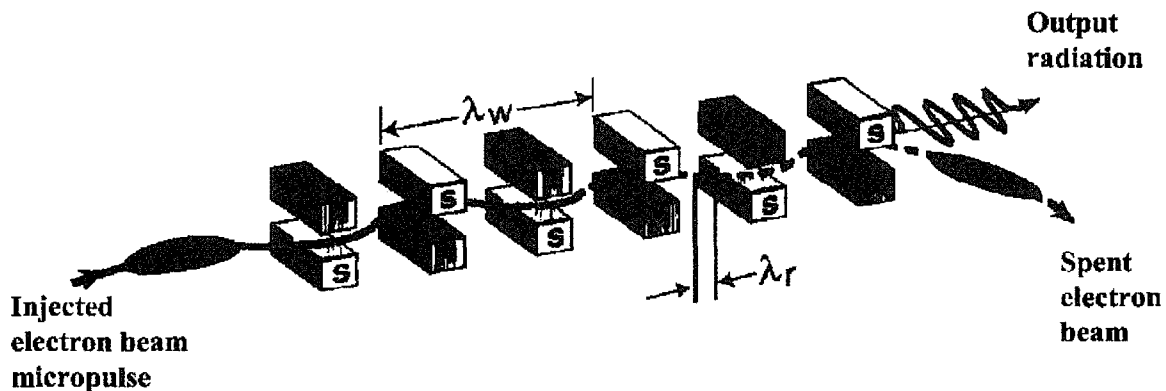

Figure 8. Free-Electron Laser Wiggler

Resonator optics on each end of the wiggler repeatedly reflect the optical bunches back through the wiggler to increase their strength. The lasing wavelength can be chosen by proper design of the wiggler and selection of the electron beam's energy. Figure 9 is a diagram of a 2 kW infrared FEL built by the Thomas Jefferson National Accelerator Facility. The highest average power FEL to-date is 10 kW.

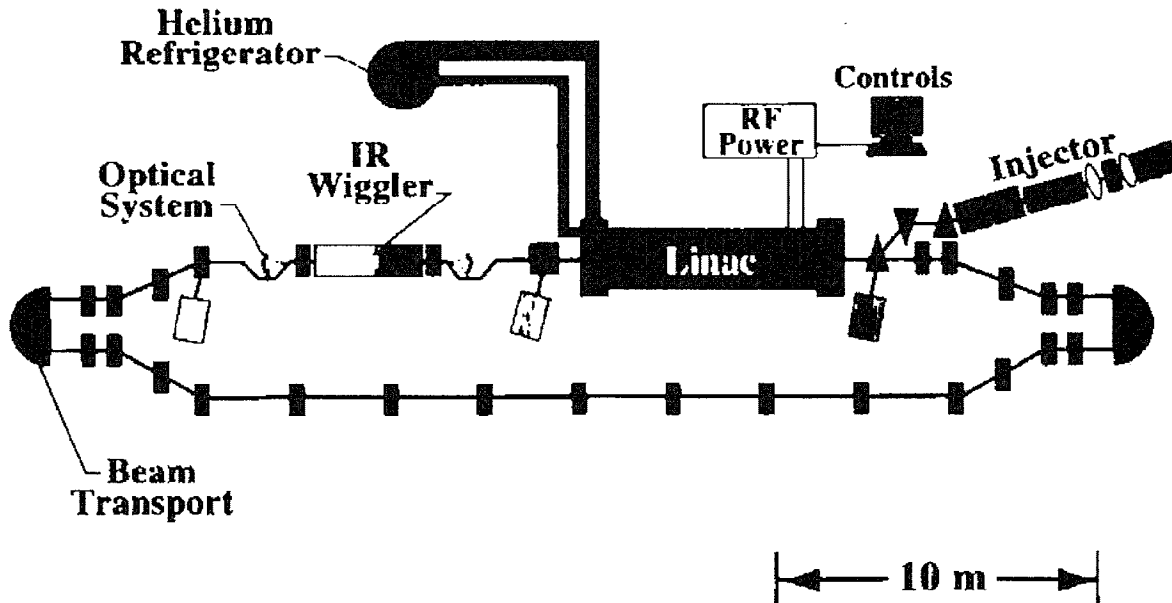

Figure 9. Elements of the 2 kW FEL at Thomas Jefferson National Accelerator Facility

Like chemical lasers, FELs have the potential to produce megawatt class average power. Unlike chemical lasers, FELs do not rely on potentially hazardous chemical reactions to generate a beam but they do require an electrically powered RF linear accelerator which is cooled to superconducting temperatures by a large refrigerator. Precise control of many megawatts of circulating relativistic electron beam is also needed. Many large RF linear accelerators have been built around the world for research purposes but all are laboratory devices. A small particle accelerator has been ruggedized and flown in space but never used operationally in a military environment. It remains to be seen if the significant technical issues associated with average power scale-up can be resolved in the laboratory and then engineered to function in a military environment such as on-board a ship.

## Beam Control and Atmospheric Propagation of Laser Devices

Referring back to Figure 2, the beam control system includes that portion of the weapon system which generates the HEL beam inside the laser gain generator, relays and aligns it through the optical train, expands it using the pointing telescope, and then focuses it at the range of the target. It also contains the sensors and trackers which acquire the target and hold it stably in the field of view. Since the HEL beam's spot on the target is generally much smaller than the target, the beam control system must identify the desired aim point on the target and place the HEL beam there for a sufficient duration to inflict damage. If wavefront sensors and deformable mirrors are used to improve the laser's beam quality (referred to as "local loop" adaptive optics) or to compensate for atmosphere distortion (referred to as "target loop" adaptive optics), then they are also part of the beam control system. If the propagation path is

completely in the vacuum of space, there is obviously no need for target loop adaptive optics.

The measure of a beam control system's performance is its ability to maximize the HEL beam's average irradiance (watts/cm<sup>2</sup>) in the focused spot on the aim point and maintain it there while sufficient fluence (watts/cm<sup>2</sup> × time or joules/cm<sup>2</sup>) is accumulated. The total power in this focused spot is typically about one-half of the laser's output power further reduced by losses in the beam control system's optical train and the atmosphere.

The laser beam's spot size on the target has many contributors. Optical diffraction establishes the spot's minimum area at approximately  $(R\lambda/D)^2$  where R is the range to the target,  $\lambda$  is the laser beam's wavelength and D is the diameter of the pointing telescope. Improvement can be only achieved by reducing the range to the target, using a laser with shorter wavelength or increasing the pointing telescope's size. This ideal (diffraction limited) spot area, is unachievable in a real system. Additional contributors to the actual spot area include a less-than-perfect laser beam (beam quality greater than one), mechanical jitter of the beam control system from the tracker, the alignment systems, or base motion disturbance and atmospheric distortions from turbulence or thermal blooming. Each of these contributors to the laser beam spot's area serve to reduce the irradiance by spreading the laser power over a larger area.

Figure 10 is a cartoon of the gimbaled portion of a beam control system and is used to illustrate basic servo control functions. A tracking telescope and optical sensor are mounted on the elevation over azimuth gimbal. Their purpose is to generate an electronic image of the target and send it to the tracker. This tracker is a special-purpose computer which then processes the target image, identifies the desired aim point and measures the angle between it and the optical boresight of the telescope. Its output is a command to the gimbals to rotate until the optical axis of the tracking telescope is following the target and pointing at the aim point. If the gimbals are mounted on a moving or vibrating platform, these disturbances introduce additional tracking errors. Unlike target motion, this base motion disturbance can be directly measured using gyros and accelerometers which are attached to the telescope. This package, called an Inertial Reference Unit (IRU), provides an additional command to the gimbals which stabilizes the telescope and improves the tracker's ability to measure target motion errors. The HEL, shown simply in this cartoon as a box, provides the weapon beam to a pointing telescope which is then mechanically boresighted (optical axis made parallel) to the tracking telescope. Finally, the range to the target must be measured so that a parallax correction can be applied to the pointing telescope. This slightly tilts its optical axis to intersect the tracking telescope's optical axis at the range of the target and thus place the HEL beam on the aim point.

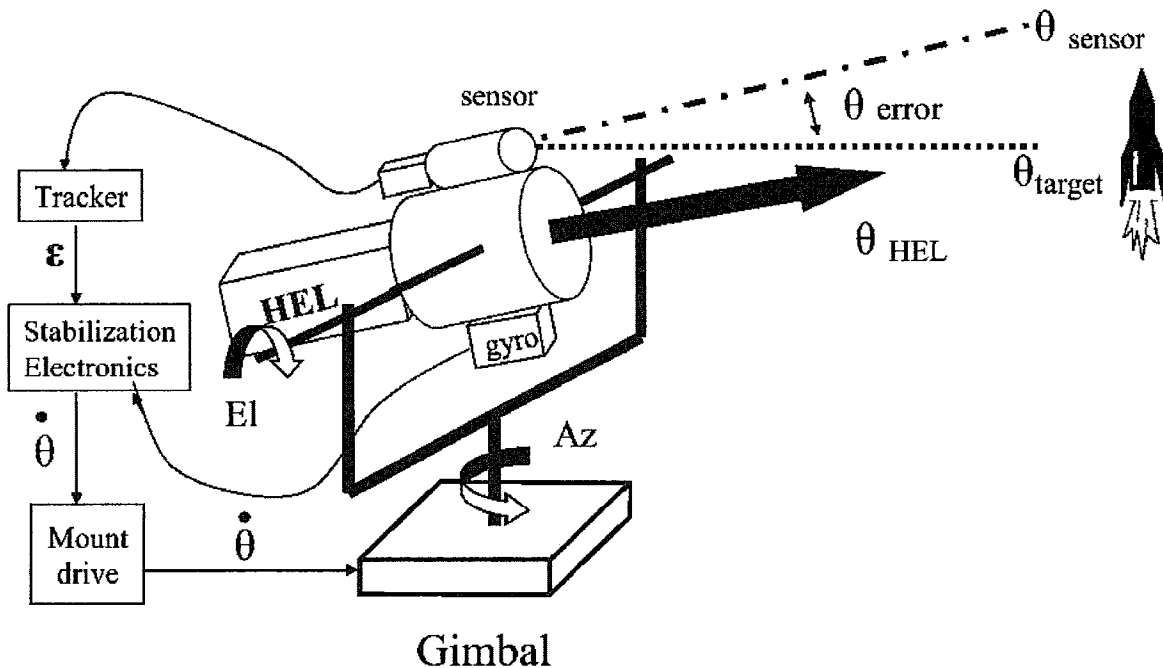

Figure 10. HEL Weapon Basic Tracking and Pointing Controls

The concept described above and illustrated in Figure 10 was used for beam control systems until the 1980s. At that point, there was a desire for higher performance systems using larger pointing telescopes but with lower jitter. This conflicting set of requirements (more massive telescopes and higher structural resonant frequencies) was first resolved in the SeaLite Beam Director (SLBD) shown in Figure 11. Instead of attaching the IRU to the pointing and tracking telescopes then attempting to mechanically stabilize them, the IRU was loosely mounted inside the pointing telescope. Using an optical reference attached to the IRU, its measurement of base motion disturbance was relayed to the SLBD's optical alignment sensors which commanded small fast steering mirrors to stabilize the HEL beam. The large telescope was then allowed to experience the base motion disturbance even though the HEL beam passing through it was stabilized.

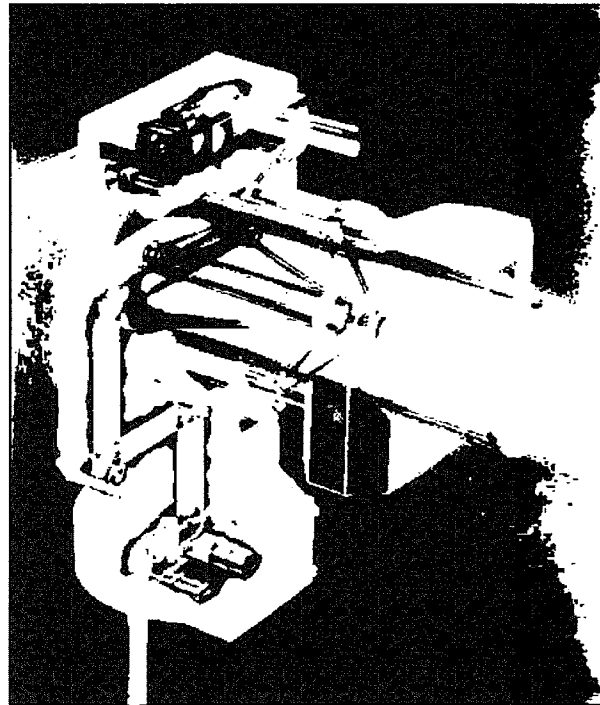

Figure 11. SeaLite Beam Director

The lower atmosphere is a difficult medium through which to propagate a laser beam. The molecules which make up the atmosphere and the aerosols which are suspended in it can scatter and absorb light, reducing the number of photons which arrive at the target. These effects are collectively referred to as "atmospheric extinction." Atmospheric ducting can bend the laser beam (this causes mirages), and atmospheric turbulence or thermal blooming (explained later) can enlarge the spot. These effects combine to reduce the beam's irradiance (measured in watts/cm<sup>2</sup>) on the target and its effectiveness. Some are almost independent of wavelength while others can vary dramatically with small changes in wavelength. As a result, the wavelength for a laser weapon which operates in the lower atmosphere must be carefully chosen.

Scattering occurs when photons strike molecules or aerosols in the atmosphere and are reflected away from the target direction. This effect is commonly observed in haze or fog but always exists, even in the clearest of skies. For example, as much as 50 to 75 percent of a laser beam's energy can be lost over a 10 km lower atmosphere path on a fairly clear day. Within reasonable limits, this reduction in photons reaching the target can be accommodated by increasing the laser power or reducing the range to the target. The losses due to scattering vary quite slowly with changes in wavelength; longer (infrared) wavelengths are less affected than shorter (visible) as can be seen from the green curve in Figure 12.

Absorption occurs when molecules or aerosols in the atmosphere absorb some of the photons. This phenomenon, caused by resonant interaction, is very strongly dependent on wavelength and can vary by orders of magnitude with wavelength changes of a fraction of a micron (red curve in Figure 12).

Extinction (the sum of absorption and scattering) is shown by the yellow curve in Figure 12 and for a low-power laser, there is no apparent difference as both effects simply reduce the number of photons which strike the target. However, if enough energy is absorbed in the laser beam's path (when using a high-power laser), it heats slightly which causes a distortion and defocusing of the laser beam. This effect is called thermal blooming and can be a significant limit on the performance of a lower atmosphere based MW-class laser system. It was a key reason (beyond the desire to eliminate chemicals) why the Navy abandoned development of DF chemical laser weapons for self-defense where thermal blooming is at its worst. One can see from Figure 12 that wavelengths around 1  $\mu\text{m}$ , 1.2  $\mu\text{m}$ , 1.6  $\mu\text{m}$  and 2.2  $\mu\text{m}$  offer the lowest absorption windows. Unfortunately, no MW-class lasers existed at those wavelengths and no candidates were apparent. For this reason, the Navy began the development of FEL technology which can be tuned to any desired optical or infrared wavelength.

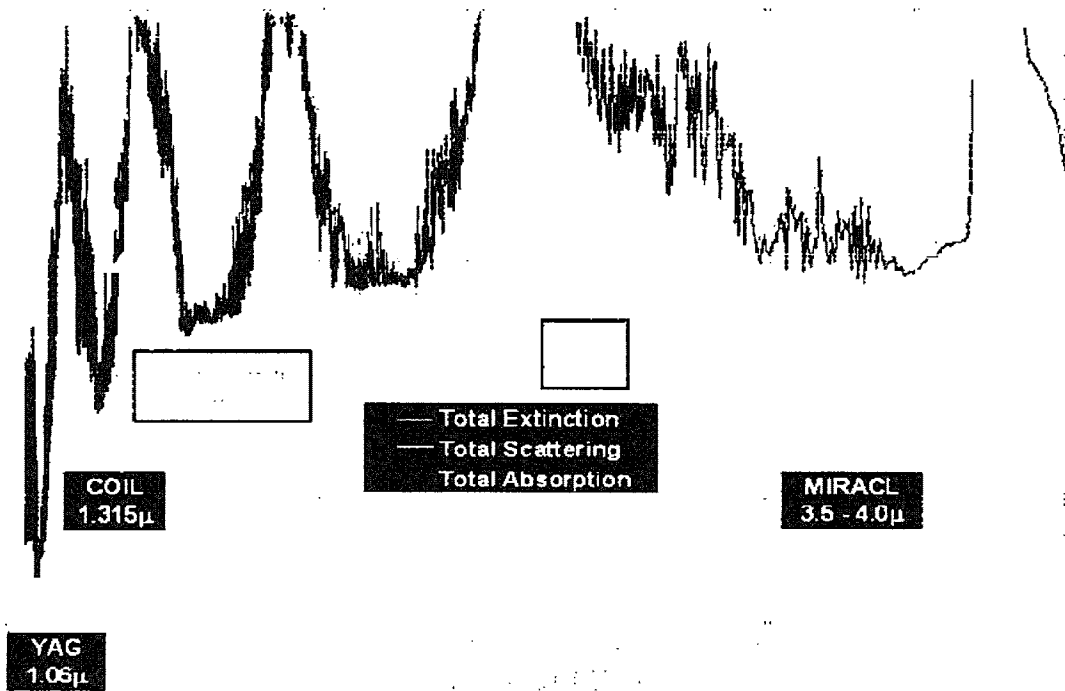

Figure 12. Typical Atmospheric Absorption and Scattering in the Infrared

## Brief History of DoD Laser Weapon Research

The Department of Defense began funding research in high energy lasers soon after the invention of the laser in 1960 when it was thought that they might (if scalable to high power) have tremendous impact on how wars were fought. The Advanced Research Projects Agency led the way with studies on the use of lasers for strategic applications, such as anti-satellite and anti-ICBM, while each of the services began looking at more modest tactical applications and began building one-of-a-kind demonstrators. By the mid-1970's, the Army had placed a 50 kW carbon-dioxide (CO<sub>2</sub>) laser with a 40 cm beam director in a tracked vehicle called the Mobile Tactical Unit (MTU) and had shot down small drone aircraft. The Air Force placed a larger CO<sub>2</sub> laser in a KC-135 (the Airborne Laser Laboratory or ALL) and, by the early 1980's, had used it to shoot down air-to-air missiles such as the AIM-9. See Figures 13 and 14.



Figure 13. Army Mobile Tactical Unit



Figure 14. Air Force Airborne Laser Laboratory

In 1973, a new chemical laser technology, based on deuterium fluoride (DF), was determined to be scalable to high power at mid-infrared wavelengths which propagate far better in the atmosphere than CO<sub>2</sub> laser beams. The Navy and ARPA jointly built a multi-hundred-kW class laser and mated it with a 70 cm beam director. In March 1978, this integrated system succeeded destroying operational TOW anti-tank missiles in flight.

The Navy then used this technology to produce the nation's first MW-class HEL weapon test bed. The Mid-InfraRed Advanced Chemical Laser (MIRACL, Figure 15) and the SeaLite Beam Director (SLBD, Figure 11) were installed and integrated at White Sands Missile Range in the mid-1980s and used for experiments by the Department of Defense. Subsonic drones and multi-mach missiles as well as strapped down ICBM boosters were among the many targets successfully engaged.

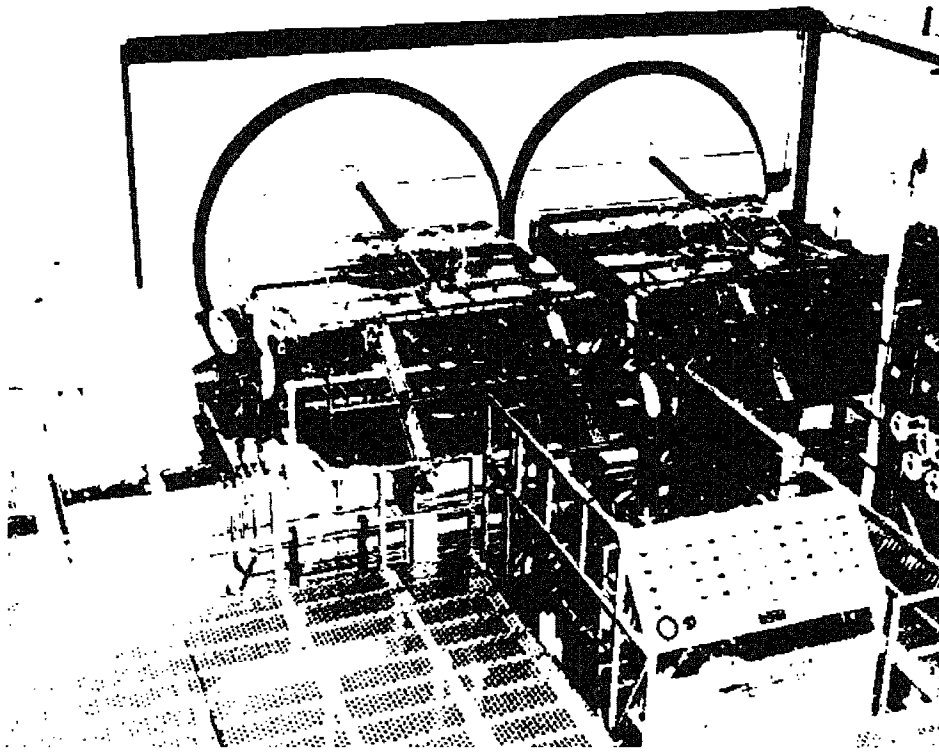

Figure 15. Mid-Infrared Advanced Chemical Laser

In 1983, President Reagan gave his "Star Wars" speech which resulted in the initiation of the Strategic Defense Initiative (SDI) and the start of a very ambitious set of HEL technology programs which peaked at a billion dollars per year. These efforts produced significant advances but did not result in the fielding of any weapons or major demonstration systems. By the mid-1990s, SDI (then the Missile Defense Agency) had terminated almost all of their HEL programs to better focus on missile development. The sole surviving MDA HEL program is the Airborne Laser (ABL) which has accounted for \$200M to \$500M/yr over the last decade. Its purpose is to place a MW-class chemical oxygen-iodine laser (COIL) system in a Boeing 747-400F (Figure 16) to demonstrate boost phase intercept of ICBMs and IRBMs.





Figure 16. MDA Airborne Laser in a Boeing 747-400F

Also in the mid-1990s, the Navy concluded that the DF laser wavelengths would not propagate adequately for use as weapons at-sea and began the development of free-electron laser technology to open more favorable propagation opportunities in the near-infrared wavelength region. To-date, FEL technology has been demonstrated at the 10 kW average power level and Navy-funded scale up continues with an ultimate goal at the MW-class.

Currently, all three services are developing solid-state slab and fiber laser technologies to support modest size, near-term, 100 kW-class weapons. These should be capable of engaging short range tactical targets such as UAVs, rockets, artillery, mortars, and swarming boats. The Air Force and the Special Operations Command (SOCOM) installed and are testing a chemical laser weapon system test-bed in a C-130, called the Advance Tactical Laser, to evaluate the utility of a laser addition to the AC-130J gunship (Figure 17).

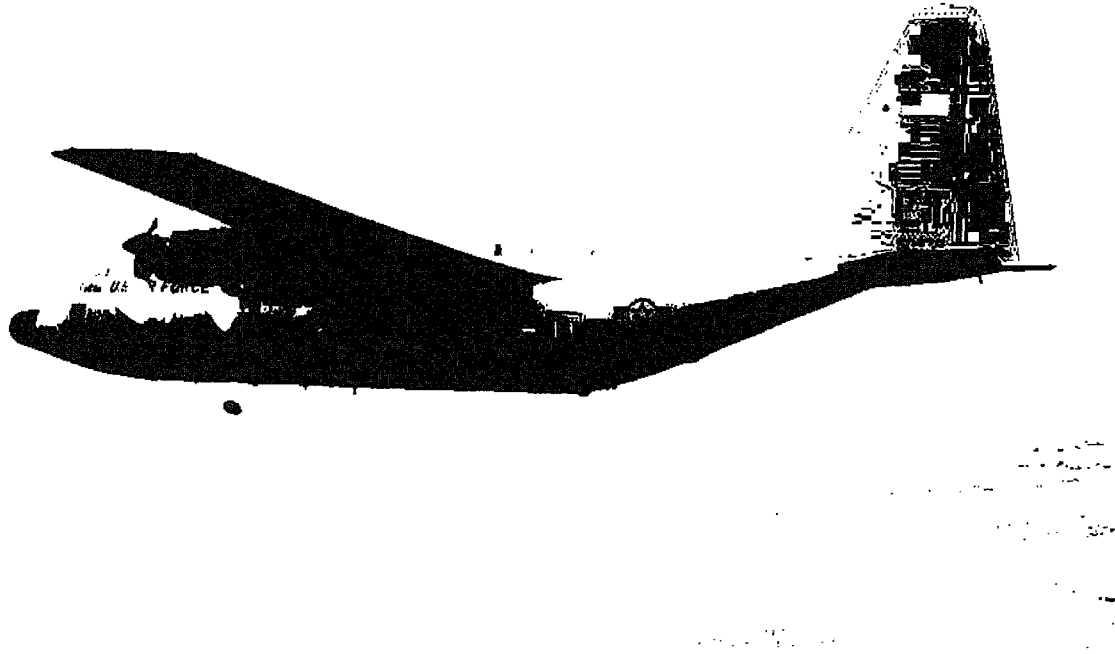

Figure 17. The Advanced Tactical Laser C-130 Aircraft

## Laser-Material Interaction

Laser radiation, with the exception of ultra-short pulse, damages materials by rapidly depositing heat on the target's surface. The field of laser effects/lethality studies this interaction at levels ranging from basic energy transfer physics to how specific military targets (such as missiles or mortar shells) could be defeated. The interaction of a laser beam with typical target materials such as metal, ceramic or fiberglass can vary significantly with parameters such as laser wavelength, irradiance level, material surface preparation and airflow. A material's hardness to laser radiation is frequently described using the parameter "W" in units of joules/cm<sup>3</sup>. This is a measure of the total energy (in joules) required to melt or remove one cubic cm of material under the specific conditions of the test. Over the past three decades, a wide variety of materials have been tested using a CO<sub>2</sub>, DF and (more recently) Nd:YAG lasers. Although specific results are usually classified, general observations can be offered about typical material classes used in aircraft and spacecraft.

A wide variety of metals are used for applications such as missile skins, pressurized fuel tanks, electronics enclosures, and structural members. Laser coupling can vary quite widely, from a few percent to almost 100 percent, depending on the laser wavelength, type of metal, surface preparation, and temperature. If not under structural load, failure is usually from complete melt-through. If the metal piece is under aerodynamic load or is part of a pressure vessel, failure will typically occur from crack initiation and propagation well before complete burn-through. Airflow is beneficial, providing melt removal and aerodynamic loads. The total energy which would cause a metal plate or pressure vessel to fail is thickness dependent in a fairly linear fashion.

Advanced airframe structures, pressure vessels and radar domes are frequently fabricated using cut glass fibers or whole fiberglass cloth layers which are impregnated with epoxy resin. These materials typically fail through a combination of thermal ablation of the epoxy and delamination. Like metals, if the piece is under aerodynamic load or is part of a pressure vessel, failure will typically occur before complete burn-through although crack initiation and propagation is less likely due to the residual strength of the fiberglass cloth after the epoxy is removed. Also, like metals the energy required for penetration is thickness dependent.

Ceramic materials, similar in composition to common Corning Ware, are routinely used in high temperature applications such as radomes for multi-mach air-to-air missiles or engine components. Although designed to handle heat when absorbed slowly, it will fracture and shatter if thermally shocked at moderate irradiance levels. Due to the poor thermal conductivity of ceramic materials, a thick piece of ceramic will shatter at almost the same irradiance and fluence levels as a much thinner piece.

A discussion of laser-material interaction requires background information on the hazards of eye damage from laser radiation. There is a popular misconception that there are "eye safe" laser wavelengths in the infrared. The reality is that any wavelength in the UV, visible or infrared can damage the eye or skin. The damage mechanisms and damage thresholds, however, are a function of the laser's wavelength, pulse length and pulse energy (if pulsed) or average irradiance (if continuous). Laser wavelengths in the UV, visible and near infrared out to about 1.2  $\mu\text{m}$  are the most dangerous. These wavelengths pass easily through the cornea and ocular fluid and are then focused on the retina where individual rods and cones can easily be permanently destroyed. This damage leaves the person with localized blind spots in the eye's field of view. Infrared wavelengths from about 1  $\mu\text{m}$  to about 1.5  $\mu\text{m}$  pass through the cornea but are absorbed by the eye's ocular fluid which results in localized heating. The damage threshold in this wavelength range is considerably higher than for retinal damage but in extreme cases the eye can be destroyed. Infrared radiation at wavelengths longer than about 1.5  $\mu\text{m}$  is absorbed by the cornea and results in scarring similar to cataracts. Although it requires considerably more energy to damage the cornea than the retina, eye and skin safety at these wavelengths cannot be ignored. There are detailed ANSI standards which establish the Maximum Permissible Exposure (MPE) as a function of wavelength and pulse/continuous beam format. Figure 18 provides an example of single pulse MPE values for a variety of wavelengths.

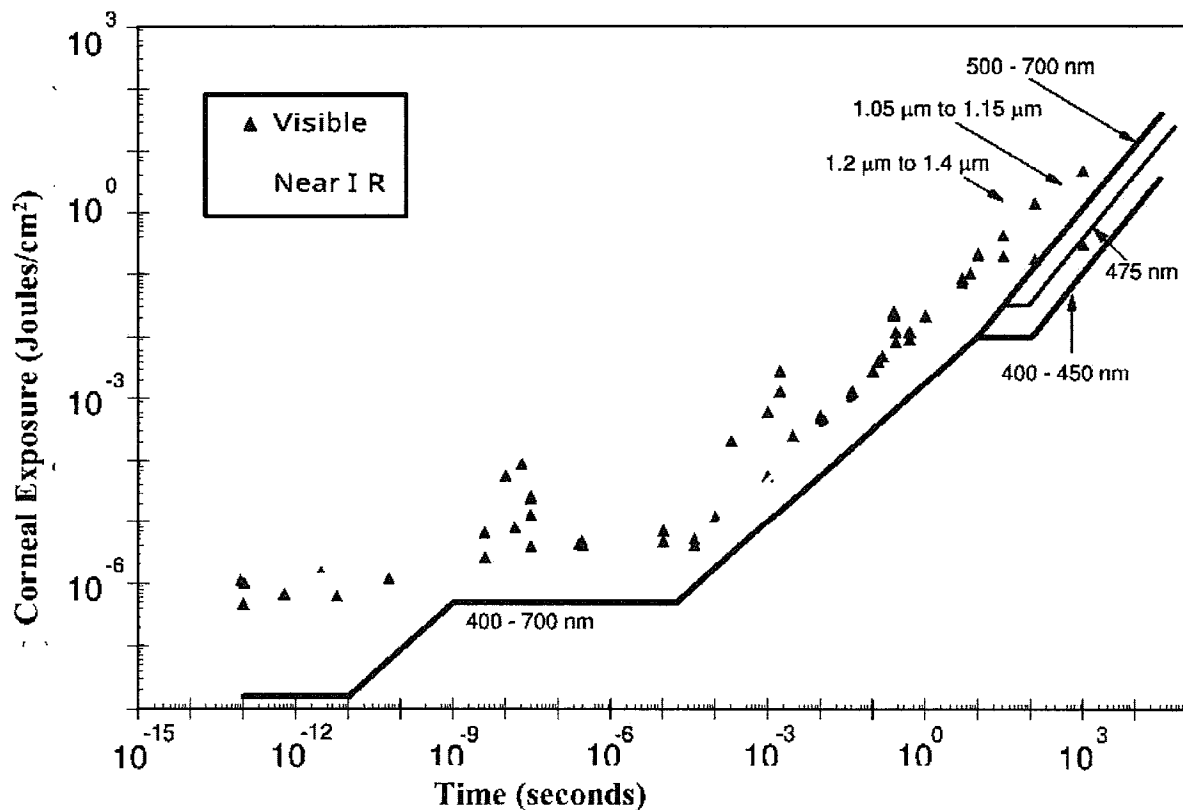

Figure 18. Single Pulse Maximum Permissible Exposure

## Vulnerability of Spacecraft to Laser Radiation

Man-made objects in space, whether in earth-orbit or beyond and manned or unmanned, have attributes which lead to unique laser radiation vulnerabilities:

- Whole-body vulnerability - Spacecraft operate in a delicate thermal equilibrium which requires maintenance of an overall, long-term temperature fairly close to 70 °F for the survival of electronics and personnel. They are heated by absorbed solar radiation, onboard electronics, mechanical and propulsion systems, internal heating systems, internal cooling systems, and any personnel on-board. Because of the surrounding vacuum, black-body radiation and material ejection are the only available methods of removing heat. If laser radiation were to permanently alter the solar absorption or black-body emission characteristics (referred to as the  $\alpha/\epsilon$  ratio) of a significant portion of the spacecraft's external surface, this thermal balance could be destroyed with slow, but catastrophic results. This damage could conceivably be inflicted rapidly from a large earth-based laser weapon, if the spacecraft were in earth orbit, or inflicted more slowly by a smaller laser weapon which was onboard a much closer spacecraft.
- Alternately, if a large earth-based laser system were to flood-load a spacecraft with a total power of megawatts for a few minutes (the typical duration of a low-earth orbit pass over a fixed location on earth), the spacecraft could potentially be heated to the point of failure.

- Component vulnerability – All spacecraft have essential components which are exposed and potentially susceptible to laser radiation. Solar panels, from either the front or back, could be damaged or shorted. Cabling among the solar panels and between the spacecraft and the panels could be damaged. If the mechanism which keeps the solar panels pointed at the sun were damaged, then the panels couldn't be rotated and would lose efficiency. Similarly, antennas used for communications or navigation are susceptible along with their RF/power cables and the mechanisms which keep them pointed. Many spacecraft use optical sensors to locate stars, the sun, or the earth's horizon for navigation or attitude determination. The loss of any of these types of sensors could significantly affect the spacecraft and could be accomplished fairly easily by a medium-to-large earth-based laser weapon if the spacecraft were in earth orbit or by a smaller laser system which was onboard another spacecraft.
- Structural penetration – A unique vulnerability of manned spacecraft is the requirement to maintain a suitable internal atmosphere. If the pressure-vessel portion of the spacecraft were penetrated, even in a small area, it could prove fatal.

The design and operation of any spacecraft should consider these vulnerabilities if damage from laser radiation is a concern. In addition to thermal modeling and careful design/shielding, candidate components, materials, and surface treatments could be tested for laser radiation susceptibility in government laboratories or independently by purchasing commercial lasers.

## Projection of Future HEL Weapon Capability

Chemical Lasers - Once the physical processes were reasonably well understood and determined to be scalable, MW-class chemical laser systems were quickly achieved by the late-1970s and still remain the sole source of that power level. Since then, the technology has matured which resulted in marginal efficiency improvements with very low probability major additional breakthroughs in this area. There are no first-principles reasons why output powers could not have been brute-force scaled upward by another decade using larger gain generators but a few practical reasons (in addition to cost) precluded that happening:

- Efficient atmospheric propagation of 10+ MW chemical laser beams would have required 10+ meter pointing telescopes which are unreasonable for any mobile or portable (including ships) military applications.
- The only possible military applications which don't suffer atmospheric propagation limitations are space-based however the weight, volume and consumption rate of chemicals would cause this to also become unreasonable and unaffordable.
- There were better wavelength choices (and potential laser types) for conceivable non-military applications such as power beaming to the moon or spacecraft in earth orbit and laser assisted propulsion of spacecraft.

Solid-State and Free-Electron Lasers - The current (and probably foreseeable future) thrust in laser development and power scaling should be expected in the area of electrically powered lasers. This will probably be true whether the laser system is earth-based or space-based. These include solid-state (slab & fiber) as well as FELs.

The reasons are that they avoid separate (and usually hazardous) fuels to carry/refuel and allow propagation at wavelengths that are favorable for use from the earth or in space. In addition to significant progress in compact, rugged, reliable and efficient laser systems for spacecraft, major developments in energy generation and storage will be needed. These lasers might be expected to have an overall "wall plug" efficiency of 25 percent, which requires at least four times the laser output power in prime power to generate the laser beam. A MW solid-state laser would require at least 4 MW of electrical power while lasing. If a low duty-cycle were allowable, much of the required lasing energy could be accumulated from a smaller prime-power source and stored in batteries, capacitors or flywheels. In addition to the energy required to support lasing, the residual energy (3 MW from a 25 percent efficient MW laser) in the form of heat must be stored and then removed from the spacecraft.

Solid-state lasers will be the optimum candidate for power in the sub-MW to MW range due to their ruggedness and relative simplicity. An FEL would be the prime candidate for power well above a MW. This type of laser lends itself better to heat removal from the gain medium than a solid-state laser. This ability of an FEL to be scaled to higher power comes with considerable additional complexity and a requirement for about a MW of continuous power to maintain a large cryogenic refrigeration system which cools the niobium accelerator cavity with liquid helium at 2K. The future development of appropriate higher temperature superconducting materials may lessen this requirement. The storage and removal of heat from any of these electrically powered lasers may prove to be a more stressing task than generation of the required prime power for lasing.

Table 1 provides an estimate of the irradiance that various potential space-based laser systems could provide. It assumes a wavelength of 1  $\mu\text{m}$ , a transmitting telescope of 1 meter diameter and a system beam quality of about 1.5. If the transmitting telescope were increased to 3 meter diameter, the same irradiance would be delivered at 3 times the range.

**Table 1: Laser Systems Irradiance Calculations**

<b>Range (km)</b>	<b>Laser Power (MW)</b>	<b>Spot Area (cm<sup>2</sup>)</b>	<b>Irradiance (kW/cm<sup>2</sup>)</b>
1000	10	50000	0.1
350	10	500	1
350	1	50000	0.1
100	1	500	1
100	0.1	500	0.1
35	0.1	50	1
10	0.1	5	10

These irradiance levels show what could be delivered with laser powers from 100 kW to 10 MW at ranges from 10 to 1,000 km. This spans a wide range of realistic powers and potential engagement ranges. The effectiveness of these irradiances against candidate spacecraft designs will need to be determined through analyses and experiments.

## Recommendations

If there are concerns about the potential vulnerability of future spacecraft to laser radiation, then the following recommendations are offered:

- Optical components, such as horizon sensors, should have their telescopes baffled and shielded to preclude the entrance of off-axis scattered light. Front shutters can be installed and kept closed when the sensor is not in use or if excess optical energy is detected.
- Antennas should be made with maximum reflectivity to UV, visible and near IR wavelengths. They should also have as much thermal mass as possible. Coax cables and power lines should be inside shields.
- Solar cells are more difficult to protect although some types are more tolerant of laser radiation and thermal overload than others. They should be wired such that a short or open in one area does not disable others. Cables should be shielded.
- Windows should have covers and potentially be coated to reflect laser wavelengths of concern. Shutters that close automatically if laser radiation is detected might also be useful.

- The thermal control paints applied to the spacecraft's surface should be tolerant of laser heating and not change their characteristics.
- The spacecraft structure should be designed to be as resistant as possible to penetration of laser energy.
- Potential materials and design approaches should be evaluated by testing for resistance to laser damage. This can be done using commercially available lasers or using available government testing facilities.

## Sources of Further Information

Only one professional society in the United States is centered on development of high-energy laser and high-power microwave weapons and technologies: the Directed Energy Professional Society (DEPS). This organization holds a variety of conferences each year focused on various aspects of directed energy weapons. All of the conferences have portions that are unclassified, and some have classified sessions. Additionally, half-day and full-day introductory or special topic courses are frequently taught prior to the first day of the meetings. Examples of DEPS conferences each year are given below; further information can be obtained from its website ([www.DEPS.org](http://www.DEPS.org)):

- Directed Energy Systems Symposium.
- Directed Energy Programs and Capabilities Conference.
- Solid-State and Diode Laser Technology Review.
- Ultrashort Pulse Laser Workshop.
- Directed Energy Test & Evaluation Conference (cosponsored with the International Test & Evaluation Association).
- Annual Directed Energy Symposium.

Other societies (U.S. and foreign) have conferences and publications related to the general fields of lasers and optics. Two major examples are:

- SPIE (originally the Society of Photo-Optical Instrumentation Engineers) who have many conferences annually and sponsor a major event called "Photonics West". Their web site is [www.spie.org](http://www.spie.org).
- American Institute of Aeronautics and Astronautics (AIAA) has an annual spring conference on Beam Control. Their web site is [www.aiaa.org](http://www.aiaa.org).
- Air Force Institute of Technology ([www.afit.edu](http://www.afit.edu)) offers a web-based course on HEL weapon technology and systems.